



Instructions for Use



CE
0297

implantmed
SI-1010 / SI-1015 / SI-1023

Contents

Symbols.....	3 – 7
1. Introduction.....	8 – 9
2. Electromagnetic compatibility (EMC)	10
3. Unpacking.....	11
4. Equipment supplied	12
5. Safety notes.....	13 – 21
6. Description of front panel.....	22
7. Description of rear panel.....	23
8. Description foot control S-N2/S-NW	24 – 25
9. Description of motor with cable	26
10. Start-up – General.....	27
11. Switching the control unit on/off	28
12. Icons – Navigation / Information / Main menu / Programme / Setup.....	29 – 34
13. Starting operation – Setup wizard	35
14. Control unit operation – Main menu	36 – 37
15. Control unit operation – Factory settings	38 – 40
16. Control unit operation – Setup	41
17. Control unit operation – System	42 – 43
18. Control unit operation – Documentation (DOCU).....	44 – 45
19. Error messages	46 – 47
20. Hygiene and maintenance	48 – 53
21. W&H accessories and spare parts	54 – 55
22. Servicing.....	56 – 57
23. Technical data	58 – 59
24. Disposal.....	60
Course certificates.....	61, 63
Explanation of warranty terms.....	65
Authorized W&H service partners.....	67

Symbols in the Instructions for Use



WARNING!
(if persons could be injured)



ATTENTION!
(if property could be damaged)



General explanations,
without risk to persons or property



Thermo washer disinfectable

















Sterilizable
up to the stated temperature



Call customer service

Symbols on the control unit

	Follow Instructions for Use		Class II equipment		Article number
	Consult Instructions for Use		Foot switch		Serial number
	Date of manufacture		On / Off	V	Supply voltage of the control unit
	Do not dispose of with domestic waste		Electric fuse	AC	Alternating current
	Data Matrix code for product information including UDI (Unique Device Identification)		Type B applied part (not suitable for intracardiac application)	VA	Power consumption of the control unit
	CE mark with identification number of the Notified Body			A	Supply current
	The medical device with reference to electrical safety, mechanical safety and fire prevention conforms to UL 60601-1:2006, CAN/CSA-C22.2 No.601.1-M90:2005, CAN/CSA-C22.2 No. 60601-1:2008, ANSI/AAMI ES 60601-1:2005 25UX (Control No.)			Hz	Frequency of the alternating current
				rpm	Revolutions per minute (= rpm)

Symbols on the foot control

 CE mark
with identification number
of the Notified Body



Non-ionizing electromagnetic
radiation



Article number



Do not dispose of with
domestic waste



Battery compartment closed



Serial number



Data Matrix code
for product information
including UDI (Unique Device
Identification)



Battery compartment open





Date of manufacture



UL Component Recognition
Mark indicates compliance
with Canadian and U.S.
requirements

Symbols on the packaging

 CE mark
with identification number
of the Notified Body

 This way up

 Fragile, handle with care

 Keep dry

 »Der Grüne Punkt« (The Green Dot)
trademark of Duales System
Deutschland GmbH

 Trademark of RESY OfW GmbH
for identification of recyclable
transport and outer packaging
of paper and cardboard

 Data Matrix code
for product information including UDI
(Unique Device Identification)

 Data structure in accordance with
Health Industry Bar Code

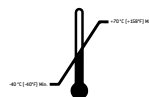
 Permitted temperature range

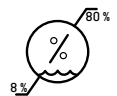
 Humidity,
Limitation

 Caution! Federal law restricts this device to sale
by or on the order of a dentist, physician or any
other practitioner licensed by the law of the state
in which he or she practices to use or order the use
of the device.

Symbols on the irrigation tubing set



Consult Instructions for Use



Not for re-use



Latex-free



CE mark
with identification number
of the Notified Body



Use by



Sterilization with
ethylene oxide



Batch code



Caution! Federal law restricts this device to sale by or on the order of a dentist, physician or any other practitioner licensed by the law of the state in which he or she practices to use or order the use of the device.

1. Introduction



For your safety and the safety of your patients

These Instructions for Use explain how to use your product. However, we must also warn against possible hazardous situations. Your safety, the safety of your team and, of course, the safety of your patients, are of paramount importance to us.



Observe the safety notes on pages 13 to 21.

Intended use

Mechanical drive unit with coolant supply for transmission instruments with ISO 3964 (DIN 13940) compatible coupling system, for use in dental surgery, implantology and maxillofacial surgery (CMF).



Misuse may damage the Implantmed and hence cause risks and hazards for patients, users and third parties.

Qualifications of the user

The W&H Implantmed is intended for use by suitably qualified and trained medical, technical and specialist staff only. We have based our development and design of the Implantmed on the "physician" target group.

Introduction



Production according to EU Directive

The medical device complies with the regulations of Directive 93/42/EEC.



Responsibility of the manufacturer

The manufacturer can only accept responsibility for the safety, reliability and performance of the Implantmed when compliance with the following instructions is ensured:

- > The Implantmed must be used in accordance with these Instructions for Use.
- > The Implantmed has no components that can be repaired by the user. Assembly, modifications or repairs must only be undertaken by an authorized W&H service partner (see page 67).
- > The electrical installation at the premises must comply with the regulations laid out in IEC 60364-7-710 (“Installation of electrical equipment in rooms used for medical purposes”) or with the regulations applicable in your country.
- > Unauthorized opening of the control unit invalidates all claims under warranty and any other claims.

2. Electromagnetic compatibility (EMC)



Medical electrical equipment is subject to particular precautions with regards to EMC and must be installed and put into operation in accordance with the EMC notes included.

W&H only guarantees compliance of the control unit with the EMC Directives when it is used with original W&H accessories and spare parts. The use of accessories and spare parts that have not been approved by W&H may lead to increased emission of electromagnetic interference or to reduced resistance to electromagnetic interference.



You can find the current EMC manufacturer's declaration on our website at <http://wh.com> or, alternatively, you can also request a copy directly from the manufacturer.



HF communication equipment

Do not use any portable and mobile HF communication equipment (e.g., mobile telephones) during operation. These may affect medical electrical equipment.

3. Unpacking

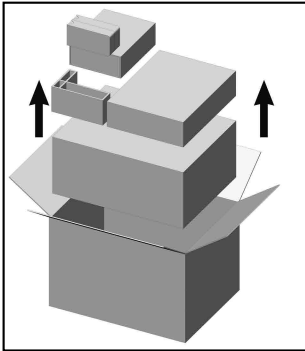

❶ Remove the packaging.

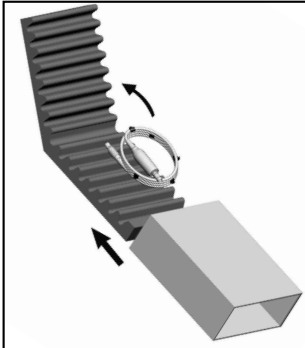

❷ Remove the motor with cable.

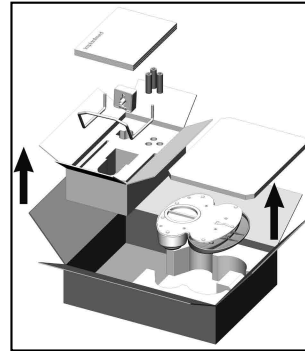

❸ Remove the foot control, instructions for use and accessories.

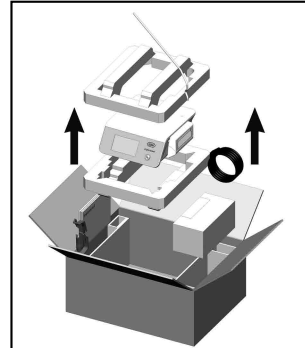

❹ Lift out the insert with the control unit. Remove the mains cable, irrigant support, universal support, irrigation tubing set and instructions for use.

W&H packaging is environmentally friendly and can be disposed of by industrial recycling companies. However, we recommend that you keep the original packaging.

4. Scope of delivery

REF	Description
30288000	Control unit SI-1023 (230 V)
30289000	Control unit SI-1015 (115 V)
30290001	Control unit SI-1010 (100 V)
30281000	EM-19 LC motor with electrical contacts and 1.8 m cable incl. 5 hose clips
30185000	EM-19 motor without electrical contacts with 1.8 m cable incl. 5 hose clips
04363600	Irrigation tubing set 2.2 m (3 pcs, disposable)
07721800	Universal support
04005900	Irrigant support
01343700	EU mains cable
02821400	Mains cable USA, CAN, J
03212700	Mains cable UK, IRL
04280600	Mains cable CH
05901800	Mains cable DK
02909300	Mains cable AUS, NZ
05333500	Mains cable BR

5. Safety notes – General



- > Before using the Implantmed for the first time, store it at room temperature for 24 hours.
- > Check the control unit and the motor with cable for damage and loose parts every time before use.
- > Do not operate the control unit and the motor with cable if it is damaged.
- > Check the parameter settings every time the device is restarted.
- > Perform a test run prior to every treatment.
- > The responsibility for the use and timely shutdown of the system lies with the user.
- > Ensure that it is possible to complete the operation safely should the units or instruments fail.

Control unit

- > Use only original W&H fuses
- > Never touch the patient and the electrical connections on the control unit simultaneously.
- > Make sure that no computer viruses are transferred to the control unit by an external data medium (USB stick).



Hygiene and maintenance before using for the first time

- > Sterilize motor with cable and universal support prior to every use.
- > Clean and disinfect the irrigant support in the thermo washer disinfectant.



Improper use

In addition to unauthorized assembly, installation, modification of or repairs to the control unit, motor with cable, dental handpieces and non-compliance with our instructions, improper use will void the warranty and release us from all other claims.

Safety notes – Control unit



The control unit is classed as “conventional equipment” (closed equipment without protection against the ingress of water).



Use the control unit in the WS-75 und WI-75 (20:1) ratios exclusively with the contra-angle handpieces approved by W&H. Use of other contra-angle handpieces may result in deviation from the indicated torque. The user alone is therefore responsible for the above. The manufacturer does not accept any liability.



Power failure

In the event of a power failure, if the control unit is switched off, or when switching between programs, the last values set are saved and re-activated on power-up.

System failure

A total system failure does not constitute a critical fault.

Safety notes – Control unit



Mains cable / Power switch

- > Only use the mains cable supplied.
- > Plug the mains cable only into a earthed power socket.
- > Set up the control unit so the power switch is easily accessible.



Disconnect the control unit from the power supply in case of danger.

- > Turn off the control unit at the power switch.
- > Pull the power plug out of the socket.



Rotational energy

Fast deceleration of the bur can, at times, cause the selected torque to be temporarily exceeded, compared to the value set, as a result of the rotational energy stored in the drive system.



Observe the manufacturer's speed and torque specifications for retaining screws for superstructures. Adjusting these retaining screws with an electric motor presents a potential risk as described above.

Safety notes – Control unit and motor



Danger zones M and G

The control unit is not suitable for use in potentially explosive atmospheres or with potentially explosive mixtures of anaesthetic substances containing oxygen or nitrous oxide according to IEC 60601-1/ANSI/AAMI ES 60601-1.



The control unit is not suitable for use in oxygen-enriched atmospheres.



Zone M, also referred to as the “medical environment”, includes the part of a room in which potentially explosive atmospheres may occur as a result of the use of analgesics or medical skin cleaning or disinfectants, but only in small quantities and only for a short time.

Zone M comprises a truncated pyramid below the operating table which is tilted outwards at a 30° angle.



Zone G, also referred to as an “enclosed medical gas system”, comprises not necessarily fully enclosed cavities in which permanent or temporary potentially explosive mixtures may be generated, supplied or used in small quantities.

Safety notes – Control unit, motor, foot control



Risks due to electromagnetic fields

The functionality of implantable systems, such as cardiac pacemakers and implantable cardioverter defibrillators (ICD) can be affected by electric, magnetic and electromagnetic fields.

- > Find out if patients and users have an implanted device before using the product and test the possible applications.
- > Assess the risks and benefits.
- > Keep the product away from implanted devices.
- > Do not place the motor on the patient's body.
- > Take appropriate emergency precautions and take immediate action on any signs of changes to health.
- > Symptoms such as increased heartbeat, irregular pulse and dizziness can be signs of a problem with a cardiac pacemaker or ICD.

Safety notes – Foot control S-NW / S-N2



Follow the directions and safety notes in the Instructions for Use of the foot control.



The foot control is approved as per IEC 60601-1 / ANSI/AAMI ES 60601-1 for use in zone M (AP).



- > Note that when using or setting low speeds, the operation or run-down of rotary instruments is more difficult to detect.
- > The ESD spring contact on the bottom of the foot control must be in contact with the ground during operation.



ESD is the abbreviation for “electrostatic discharge”.

Safety notes – Foot control S-NW



Disposable batteries

- > Replace the disposable batteries at the first prompt (battery icon on display).
- > Replace batteries outside zone M only.
- > Use only high-quality disposable alkaline AA / Mignon / LR6 / 1,5 V batteries. Risk of explosion if the wrong type of battery is used.
- > Do not mix new, old or different types of disposable batteries.
- > Do not use rechargeable batteries.
- > When inserting disposable batteries make sure that they are correctly oriented.
- > Always keep spare batteries on hand.
- > Dispose of faulty or flat batteries immediately and correctly via recycling systems. Do not dispose of batteries in domestic waste.



Disposable batteries may cause damage due to leakage or corrosion.

- > Remove the disposable batteries if you are not going to use the foot control for a longer period.

Safety notes – Dental handpieces



- > Follow the directions and safety notes in the Instructions for Use of the dental handpieces.
- > Use only dental handpieces compatible with an ISO 3964 (DIN 13940) coupling system.
- > Follow the directions of the manufacturer of dental handpieces with reference to transmission ratio, maximum speed and maximum torque.
- > Connect the dental handpiece only if the motor is stopped.
- > Turn off the dental handpiece immediately in the event of failure in the coolant supply.
- > Check the dental handpiece for damage and loose parts before every use.
- > Do not activate the chuck mechanism of the dental handpiece during operation or slowing down.
- > Avoid overheating at the treatment site.



Rotary instruments

- > Use only rotary instruments in good condition and note the direction of rotation of the instrument. Observe the manufacturer's instructions.
- > Only insert the rotary instrument when the dental handpiece is stationary.
- > Never touch a rotary instrument that is still rotating.
- > Do not activate the chuck mechanism of the dental handpiece during operation. This leads to detachment of the rotary instrument and/or overheating of the dental handpiece.

Safety notes – Coolant supply



The Implantmed is designed for use with physiological saline solution.



- > Always ensure correct operating conditions and that sufficient and adequate cooling is delivered.
- > Always provide sufficient coolant and ensure the appropriate suction.
- > Use only suitable coolants and follow the manufacturer's medical data and instructions.
- > Use the W&H irrigation tubing set or accessories approved by W&H.

Irrigation tubing set



Sterile irrigation tubing sets are supplied with the equipment.



- > Note the expiration date and only use disposable irrigation tubing with undamaged packaging.
- > Clean and disinfect the irrigation tubing immediately after every treatment.
- > Follow your local and country-specific laws, directives, standards and guidelines for disposal.

6. Description of front panel

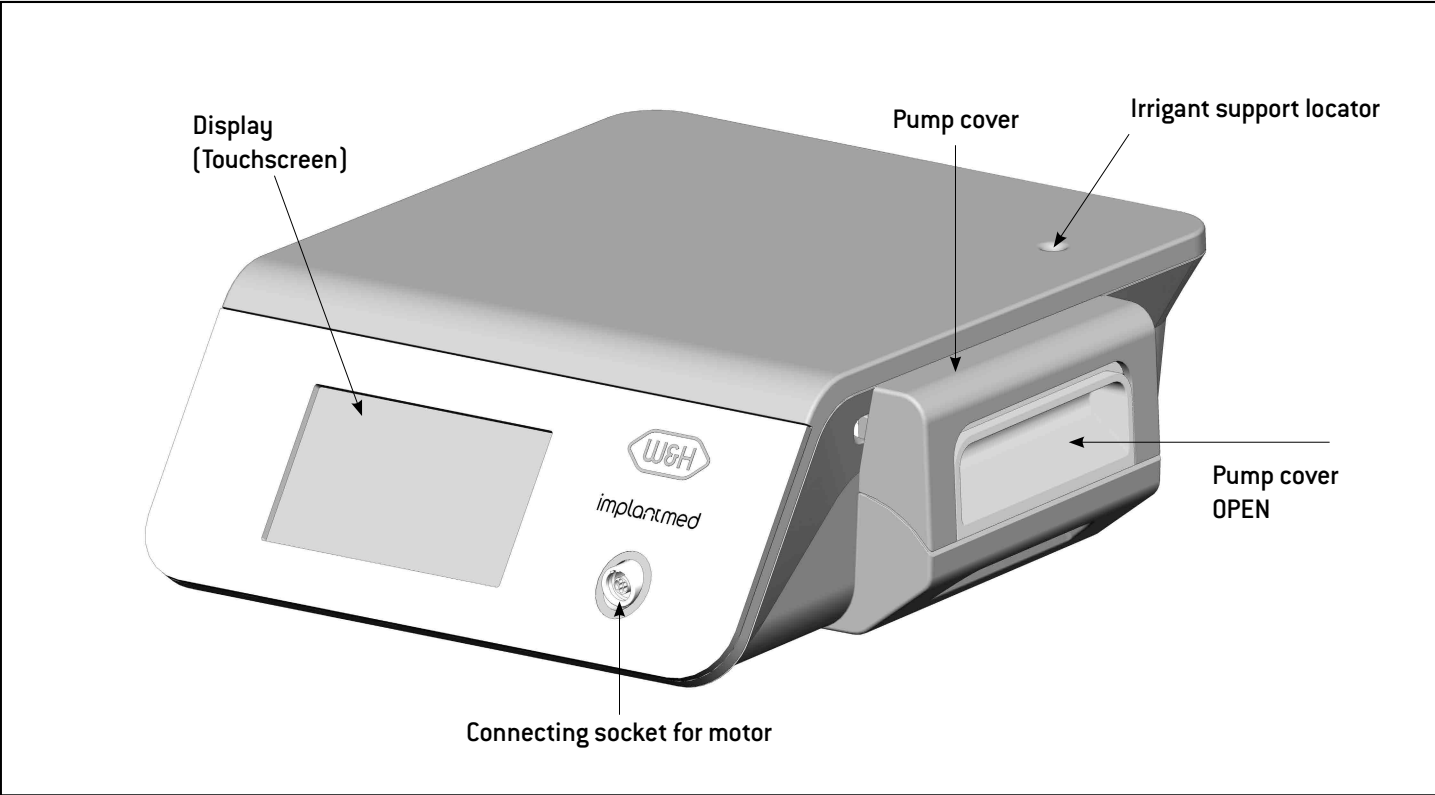

7. Description of rear panel

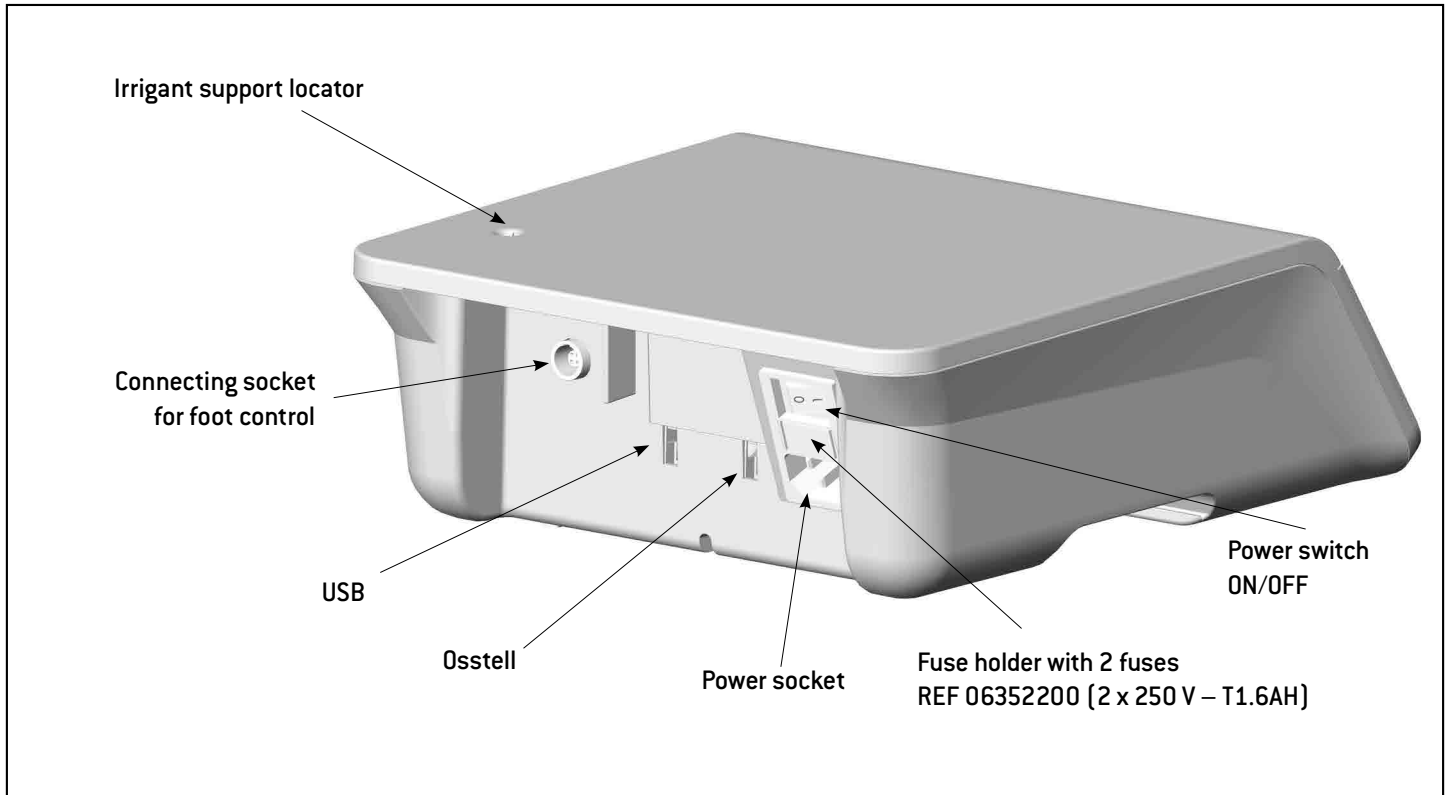

8. Description of foot control S-N2/S-NW

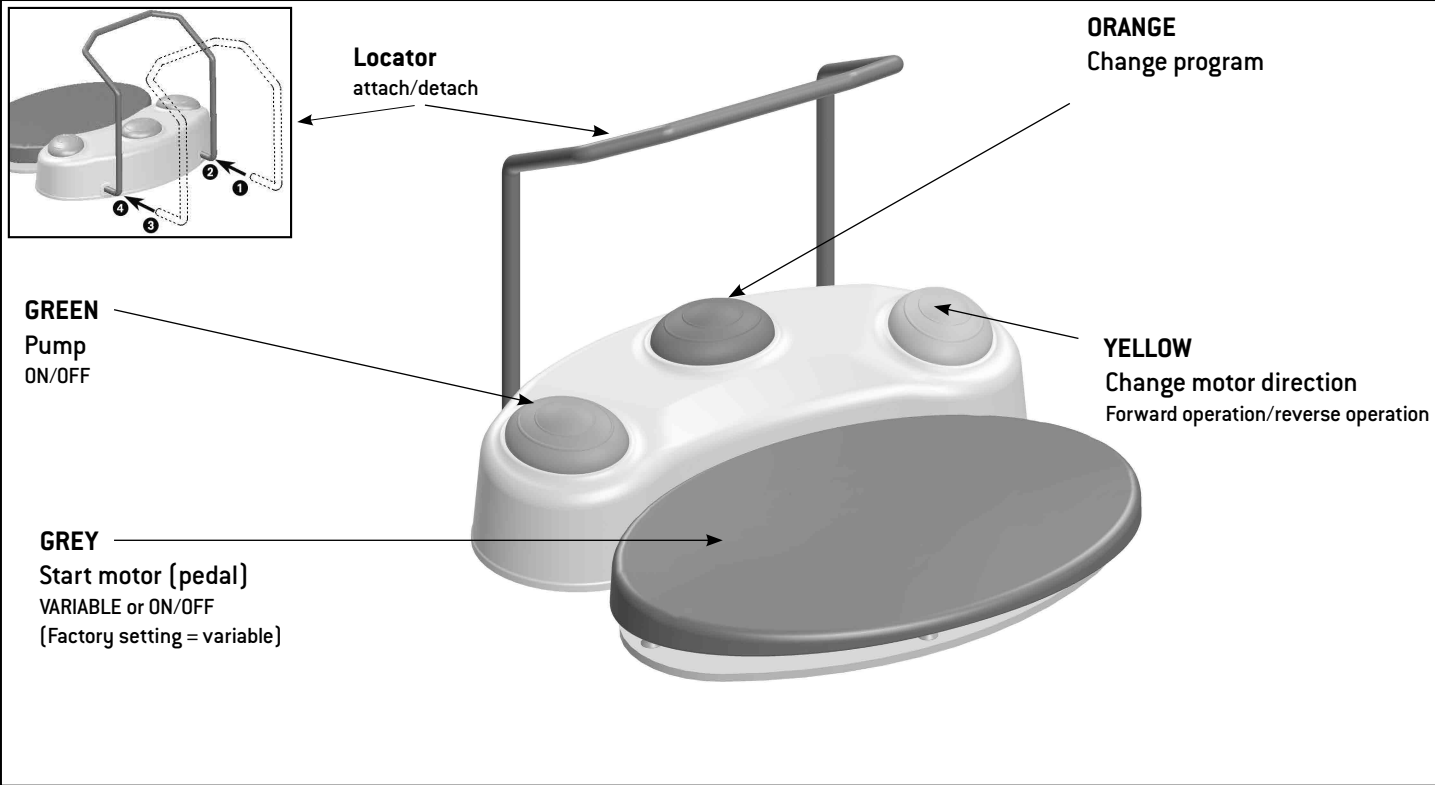

Description of foot control S-N2/S-NW

ORANGE

S-N2 / S-NW: Change program

Press the ORANGE button to change programs in ascending order. When changing from the last program to the first program a longer acoustic signal sounds.

The motor direction is automatically set to forward operation every time the program is changed.

ORANGE

S-NW: Switching between multiple control units

Press the ORANGE button to switch between the control units.

GREEN – pump ON/OFF

Only when the motor is stationary can the pump be switched on or off by pressing the GREEN button of the foot control.

YELLOW – change motor direction

Forward operation/reverse operation

Press the YELLOW button to change from forward operation to reverse operation. A signal sounds on selection and the “Forward/reverse operation mode” symbol flashes. Before the motor starts in reverse operation, 3 audible signals are given.

9. Description of motor with cable



The motor with cable must not be disassembled.

The motor with cable must not be oiled (pre-oiled for entire service life).

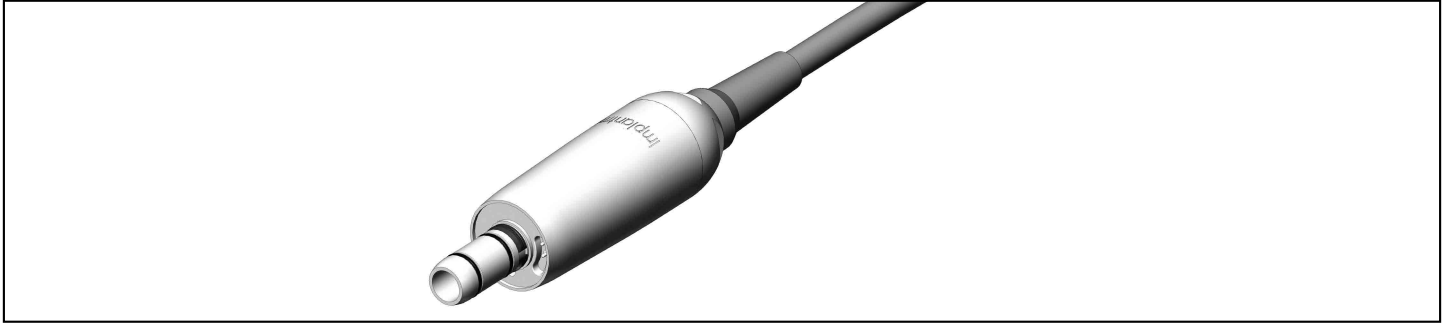

The motor with cable is a type B applied part (not suitable for intracardiac application).



Temperature information

Temperature of the motor on the operator side: max. 55°C

10. Start-up – General



Place the control unit on a flat level surface.

Ensure that the control unit can be disconnected from the power supply at any time.

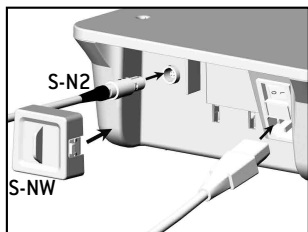

- 1** Connect the mains cable and foot control.

 Pay attention to the positioning!

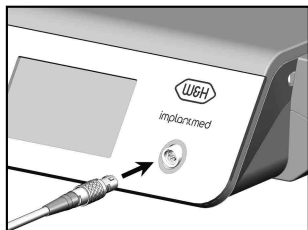

- 2** Connect motor cable.

 Pay attention to the positioning!

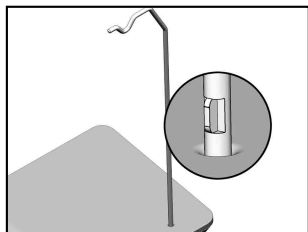

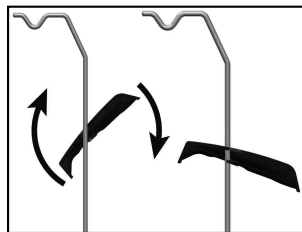

- 3** Insert the irrigant support.

 Pay attention to the positioning!
[Maximum load capacity 1.5 kg]

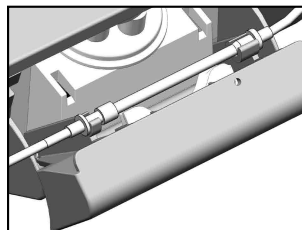

- 4** Attach the universal support and lock it.



- 5** Insert/remove the irrigation tubing.
 Pay attention to the correct order.

- > Open the pump cover.
- > Insert/remove the irrigation tubing.
- > Close the pump cover.

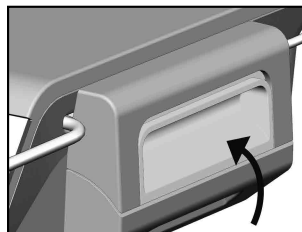

11. Switching the control unit on and off



Switching on the control unit

- 1 Plug the mains cable into a earthed power socket.

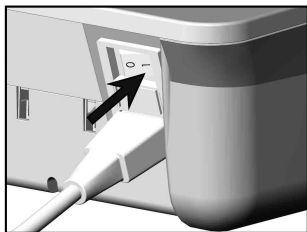

- 2 Switch on the control unit at the power switch.

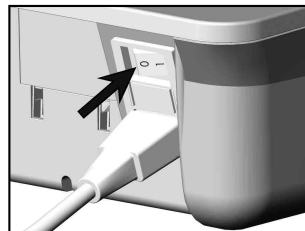

Switching off the control unit

- 1 Switch off the control unit at the power switch.

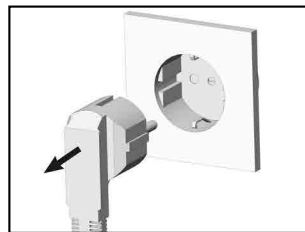

- 2 Pull the power plug out of the socket.

Test run



Do not hold the motor with dental handpiece at eye level.

- > Connect the dental handpiece to the motor. Point the dental handpiece with the head facing downwards.
- > Start the motor with the foot control.
- > In the event of malfunctions (e.g. vibrations, unusual noises, overheating, unusual noises of overheating), **stop the motor immediately** and contact an authorized W&H service partner (see page 67).

12. Icons – Navigation



Add user



Add drill protocol



Back



Confirm/save



Edit



Help



Switch to next screen



Reduce/increase

Set by pressing the minus/plus buttons or by moving the slider left or right.

Icons – Information



Setting selected



Favorite selected



black = information

green = Information with selection option



red = error message, work cannot be continued

orange = error message, work can be continued



red = replace batteries



Foot control S-NW



Foot control S-N2

Icons – Main menu

 Documentation (DOCU)

100 Total

 Activate

 New position

 Drill protocol group

 Delete

 New docu

 Drill protocol

 Favorite

 Complete docu

 Edit

 Transmission

 Bar

 Copy

rpm Speed

 Per cent

 Rename

Ncm Torque

Icons – Programs



Program 1 (P1)



Program 2 (P2)



Program 3 (P3)



Program 4 (P4)
Thread-cutter function



Program 5 (P5)
Implantation



Program 6 (P6)
Implant stability quotient measurement
W&H Osstell ISQ module is available as an accessory (REF 30210000)

Icons – Setup



Screen lock



User



System



Torque curve



Manage user



Copy



Rename



Delete



Activate



Foot control



Pairing



Variable



ON/OFF



System check



Set screen lock



Interval



LED















Fade-out time



Sound

Icons – Setup

 Device info	 Osstell	I–IV FDI (Fédération Dentaire Internationale = International dental numbering system)
 Service	 Software update	1–32 UNS (Universal Numbering System = American dental numbering system)
 Licences	 Reset	
 Module info	 Restart	
 User interface	 Language	
 Motor control unit	 Dental numbering system	
 Foot control		

13. Starting operation – Setup wizard



The touch screen must only be touched using fingers.

Using hard objects on the touch screen may scratch or damage the surface.

Setting up Implantmed

Switch on your control unit and follow the directions of the setup wizard.

The set-up wizard guides you through the various set-up stages up to the main menu:

- > Language selection
- > Selection of program setting: Standard/customized

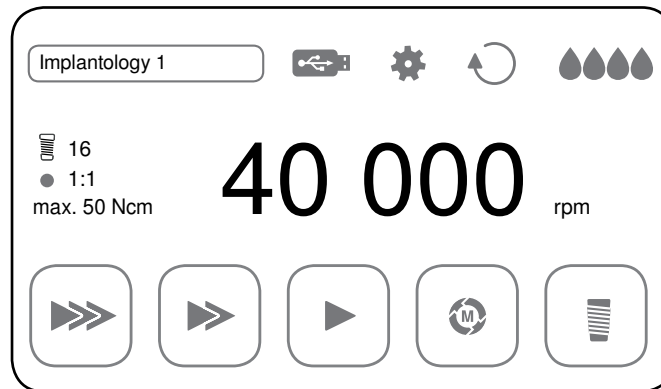

14. Control unit operation – Main menu

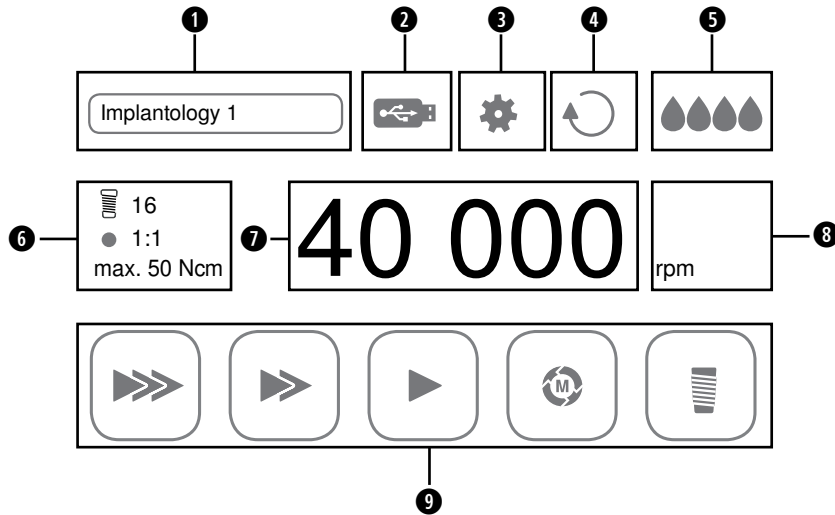

1	My favorites	6	Set program
2	Documentation (DOCU)	7	Set speed / torque
3	Setup	8	Progress display mode
4	Forward/reverse operation mode	9	Programs 1 to 5
5	Set coolant volume		

Control unit operation – Main menu

My favorites

- > Select drill protocol

Select drill protocol group

- > Create/select/change drill protocol
- > Select drill protocol: Edit, copy, rename, activate, delete, favorite



An activated drill protocol cannot be deleted

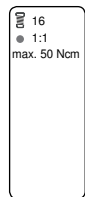

Set program

- > Transmission

- > Speed



At 40,000 rpm the accuracy of the set speed is $\pm 10\%$.

- > Torque (P4, P5)



Adjustment range 5 – 80 Ncm with WI-75 and WS-75 only

The motor switches off automatically when the set torque is reached in forward and reverse operation modes.

The accuracy of the set torque in the 20 – 50 Ncm range for the W&H WI-75 and WS-75 contra-angle handpieces is $\pm 10\%$. Greater deviations may be encountered with other contra-angle handpieces.

- > Documentation (DOCU)



DOCU only appears once the documentation has been started.

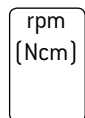



Progress display mode

- > Bar





- > Percent

- > Total

15. Control unit operation – Factory settings

Implantology 1	P1 	P2 	P3 
Transmission	1:1	WS-75 (20:1)	WS-75 (20:1)
Speed rpm	35,000	1,200	800
Setting range rpm	200 – 40,000	10 – 2,000	10 – 2,000
Motor direction of rotation	forward	forward	forward
Pump	on	on	on
Torque Ncm	100 %	100 %	100 %

Control unit operation – Factory settings

Implantology 1	P4 	P4 	P5 	P5 
Transmission	WS-75 (20:1)	WS-75 (20:1)	WS-75 (20:1)	WS-75 (20:1)
Speed rpm	15	30	20	20
Setting range rpm	10 – 50	10 – 50	10 – 50	10 – 50
Motor direction of rotation	forward	reverse	forward	reverse
Pump	on	off	on	on
Torque Ncm	20	60	20	20
Setting range Ncm	5 – 80	5 – 80	5 – 80	5 – 80

Control unit operation – Factory settings

Thread-cutter function (chip breaker mode)



When the pedal (grey) on the foot control is pressed, the thread cutter rotates inwards until the set torque is reached. The unit automatically switches to reverse operation when the set torque is reached. Disengaging and then re-engaging the pedal will switch the control unit back to forward operation.



If the thread cutter function is in reverse operation mode, the control unit can also start with the maximum torque.

16. Control unit operation – Setup



Screen lock

- > Activating / deactivating screen lock



User

- > Select / create user
- > User settings: Copy, Rename, Activate, Delete



An activated user cannot be deleted



System



Torque curve

17. Control unit operation – System

Foot control

- S-NW: > Pairing
- > Properties (VARIABLE or ON/OFF)
- S-N2: > VARIABLE or ON/OFF

System check

- > Test run

Set screen lock

- > Activating / deactivating screen lock
- > Interval: Select time

LED

- > Activating / deactivating LED
- > Fade-out time: Select time

SOUND

- > Activating/deactivating sound

Control unit operation – System



Device info

- > Service
- > Licences: GPL, LGPL
 -  GPL: GNU General Public License
 - LGPL: GNU Lesser General Public License
- > Module info: User interface (MMI), motor control unit, foot control, Osstell
- > Software pdate
- > Reset: Restore factory settings
- > Restart: Control unit restarts automatically



Language

- > Select language



Dental numbering system

- > Select dental numbering system: FDI / UNS

18. Control unit operation – Documentation (DOKU)



Drill protocols, torque curves and ISQ values can only be documented in programs 4, 5 or 6.
Documentation must be activated or deactivated for each program.



A USB stick is required to save the documentation.
Never remove the USB stick while the motor is running.

Record documentation

> Connect USB stick



Icon appears

> Enter ID

> Enter date

> Enter tooth quadrant

> Select tooth

> Confirm selection



Documentation starts when the motor starts.

Further documentation



> Add new position

> Start new docu

> Complete docu



When the motor stops, a diagram appears, which is automatically saved to the USB stick.

Control unit operation – Documentation (DOKU)

Edit documentation

A text file (csv) and a PDF file are saved on the USB stick.
The text file can be opened in Microsoft® Excel* for editing.
The pdf file can be opened in Adobe® Reader®**.

- * Microsoft® Excel® is a registered trademark of the Microsoft® Corporation in the United States of America and/or other countries.
- ** Adobe® Reader® is a registered trademark of Adobe Systems Incorporated in the United States of America and/or other countries.





19. Error messages



The error message disappears when it is clocked or when the pedal (grey) on the foot control is released.

Icon	Description of error	Solution
	WARNING FOOT CONTROL	<ul style="list-style-type: none">> Check plug-in connection of foot control> Check the plug-in connection of the dongle
	WARNING MOTOR	<ul style="list-style-type: none">> Check the plug-in connection of the motor> Allow motor to cool for at least 10 minutes
	WARNING STORAGE DEVICE <ul style="list-style-type: none">> Insufficient memory available> Unknown file system> The write protection is active> Unknown storage device	<ul style="list-style-type: none">> Plug in a USB stick with sufficient memory
	WARNING OVERHEATING	<ul style="list-style-type: none">> Switch off the control unit> Allow the control unit to cool for at least 10 minutes> Switch on the control unit

Error messages

Icon	Description of error	Solution
	WARNING TIME-OUT	<ul style="list-style-type: none"> > Release the pedal (grey) on the foot control > Allow motor to cool for at least 10 minutes
	SYSTEM ERROR	<ul style="list-style-type: none"> > Switch the control unit off and back on again  If the error message appears again, contact an authorized W&H service partner immediately.
	WARNING OSSTELL	<ul style="list-style-type: none"> > Remove the ISQ module and then reinsert or > Connect probe > Remove probe from a source of electromagnetic interference > Maintain a distance between the probe and the SmartPeg (3-5 mm) or > Switch the control unit off and back on again



- > If the described problem cannot be resolved, the unit will need to be inspected by an authorized W&H service partner (see page 67).
- > In case of a total system failure, switch the control unit off and on again.



20. Hygiene and maintenance – General

 Follow your local and country-specific laws, directives, standards and guidelines for cleaning, disinfection and sterilization.

-  > Wear protective clothing.
- > Clean and disinfect the motor with cable, the universal support and the irrigant support **immediately after every treatment!**
- > Sterilize the motor with cable and the universal support following cleaning and disinfection.

-  **Preparation of dental handpieces**
- > Note the information in the manufacturer's Instructions for Use.

Hygiene and maintenance – Control unit / foot control

-  > The front panel of the control unit and the foot control are sealed and can be wiped clean.
-  > The control unit and foot control are not approved for mechanical cleaning (thermo washer disinfectant) and sterilization.
- > Do not immerse the control unit or foot control in water or clean them under running water.

Pre-disinfection

- > If heavily soiled, clean first with disinfectant cloths.
-  Only use disinfectants which have no protein-fixing effect.

Manual cleaning

- > The ESD spring contact on the bottom of the foot control must be cleaned regularly.

Manual disinfection

-  W&H recommends wipe disinfection.
- > Use only disinfectants which do not contain chlorine and which are certified by officially accredited institutes.
- > Note the manufacturer's specifications for the use of the disinfectant.

Hygiene and maintenance – Motor with cable / universal support / stand



Do not twist or kink the motor cable! Do not coil it too tightly!

Pre-disinfection

> If heavily soiled, clean first with disinfectant cloths.



Only use disinfectants which have no protein-fixing effect.

Manual cleaning

> Rinse and brush off with demineralized water (< 38°C)

> Remove any liquid residues (absorbent cloth, blow dry with compressed air).



Do not immerse the motor with cable, universal support or irrigant support in liquid disinfectant or in an ultrasonic bath.

Manual disinfection



W&H recommends wipe disinfection.

> Use only disinfectants which do not contain chlorine and which are certified by officially accredited institutes.

> Note the manufacturer's specifications for the use of the disinfectant.

Hygiene and maintenance – Motor with cable / universal support / stand

Mechanical cleaning and disinfection (internal and external)



The motor with cable, universal support and irrigant support can be cleaned and disinfected in a thermo washer disinfectant.

- > Use only thermo washer disinfectants with a drying program for preparation.
- > Follow the manufacturer's recommendations for devices and cleaning & rinsing agents.



- > Ensure that the motor with cable is completely dry inside and outside after thermo washer disinfection.
- > Remove any liquid residues with compressed air.



After manual cleaning and disinfection, you must carry out a final sterilization (wrapped) in a class B or S steam sterilizer (as per EN 13060).

Hygiene and maintenance – Motor with cable / universal support

Sterilization and storage



W&H recommends sterilization according to EN 13060, class B.
Other sterilization methods may reduce the life span of the motor.

- > Note the manufacturer's specifications.
- > Clean and disinfect the motor with cable and the universal support before sterilization.
- > Wrap the motor with cable, universal support and accessories in sterile goods packaging according to EN 868-5.
- > Make sure that you only remove dry sterile goods from the sterilizer.
- > Store sterile goods dust-free and dry.

Motor with cable / universal support



ISO 14457 stipulates a durability of at least 250 sterilization cycles. In the case of the motor with cable by W&H, we recommend you have a regular service carried out after 500 sterilization cycles or one year.

Hygiene and maintenance – Motor with cable / universal support

Approved sterilization procedures



Follow your local and country-specific laws, directives, standards and guidelines.

- > Steam sterilization class B with sterilizers in accordance with EN 13060.
Sterilization holding time minimum of 3 minutes at 134°C

or

- > Steam sterilization class S with sterilizers including drying program in accordance with EN 13060.
The sterilizer manufacturer must expressly approve the sterilization of motors.
Sterilization holding time minimum of 3 minutes at 134°C

Before resuming operation

- > Wait until the motor with cable has cooled and is completely dry.



Moisture in the motor with cable may cause a malfunction! (Risk of short circuit)

21. W&H accessories and spare parts



Use only original W&H accessories/spare parts or accessories approved by W&H.

Reference source: W&H Partner

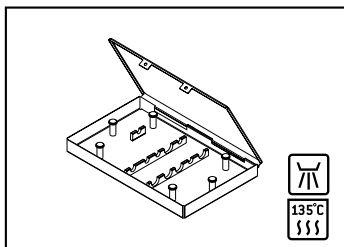

04013500

Sterilization cassette

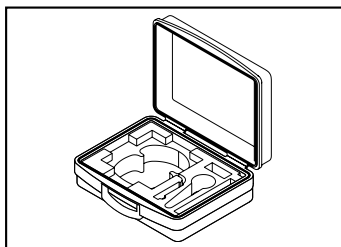

07962790

Transportation case

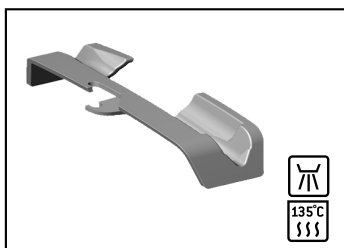

07721800

Universal support

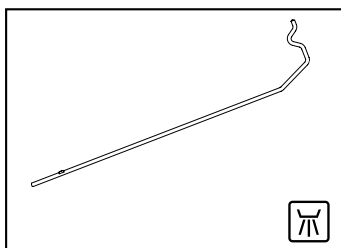

04005900

Irrigant support

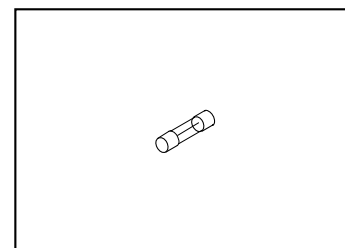

06352200

Fuse (250 V - T1.6AH)

W&H accessories and spare parts

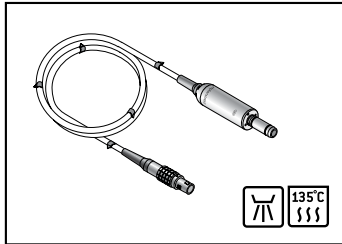

30281000

EM-19 LC motor with
electrical contacts
and 1.8 m cable

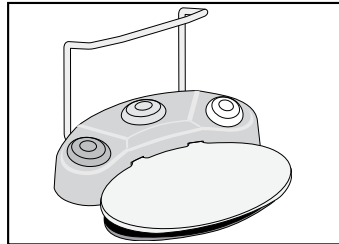

30285000

Foot control S-N2

30264000

Foot control S-NW

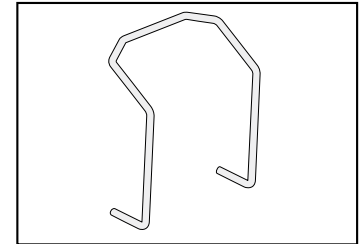

04653500

Locator for foot control

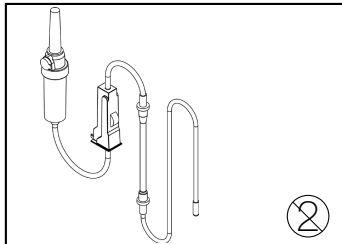

04363600

Irrigation tubing set 2.2 m (6 pcs)

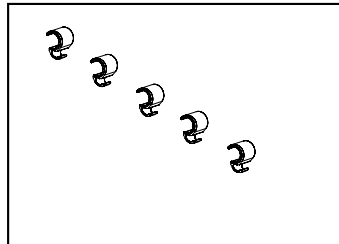

06290600

Hose clips (5 pcs)

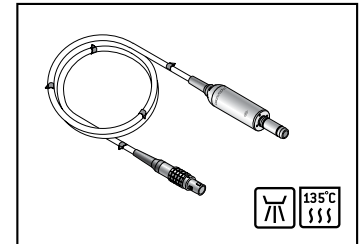

30185000

EM-19 motor without
electrical contacts
and 1.8 m cable

22. Servicing



Regular checks

Regular servicing of function and safety including the accessories is necessary and should be carried out at least once every three years, unless shorter intervals are prescribed by law. The inspection must be undertaken by a qualified organization and must include the following procedures:

Control unit

- > External visual inspection
- > Measurement of device leakage current
- > Measurement of patient leakage current
- > Visual inspection of internal components on suspicion of safety interference, e.g., mechanical damage of the enclosure or indicators of overheating

Foot control

- > External visual inspection
- > Measurement of device leakage current
- > Measurement of ESD capacity
- > Visual inspection of the ESD spring contact on the bottom of the foot control (electrostatic discharge)
- > Function test with check to see if the maximum speed can be reached



The regular inspection must only be performed by an authorized W&H service partner (see page 67).

Servicing

Repairs and returns

In case of a fault or malfunction, send the control unit, the foot control and the motor with cable for repair to an authorized W&H service partner (see page 67).



- > Always return equipment in the original packaging.
- > Do not coil the cable around the motor and do not twist or kink the motor cable. (Risk of damage)
- > Foot control S-NW: Remove the batteries.

23. Technical data

Implantmed	SI-1023	SI-1015	SI-1010
Mains voltage:	230 V	120 V	100 V
Permissible voltage fluctuation:	220 – 240 V	110 – 130 V	90 – 110 V
Rated current:	0,3 – 0,8 A	0,3 – 1,6 A	0,3 – 1,4 A
Frequency:	50 – 60 Hz		
Mains fuse (2 pcs):	250 V – T1,6AH		
Maximum power consumption:	170 VA		
Maximum power output:	80 W		
Maximum torque at motor:	6,2 Ncm		
Motor speed range in the rated voltage range:	200 – 40.000 min ⁻¹		
Coolant volume flow at 100%:	min. 90 ml/min		
Dimensions in mm (height x width x depth):	100 x 262 x 291		
Weight in kg:	3,5		

Ambient conditions

Temperature during storage and transport:	-40°C to +70°C
Humidity for storage and transport:	8% to 80% (relative), non-condensing
Temperature in operation:	+10 °C to +35 °C
Humidity in operation:	15% to 80% (relative), non-condensing

Technical data

Classification according to Paragraph 6 of the General Specifications for the Safety of Medical Electrical Equipment according to IEC 60601-1/ANSI/AAMI ES 60601-1



Class II medical electrical equipment



Type B applied part (not suitable for intracardiac application)



The foot control S-N2 (REF 30285000) / S-NW (REF 30264000) conforms to Class AP according to IEC 60601-1 / ANSI/AAMI ES 60601-1 in danger zone M



The S-N2 / S-NW foot control is waterproof according to IPX8, 1 m depth of immersion, 1 hour (water-tight in accordance with IEC 60529)

Pollution level:	2
Overvoltage category:	II
Altitude:	up to 3,000 m above sea level

24. Disposal



Ensure that the parts are not contaminated on disposal.



Follow your local and country-specific laws, directives, standards and guidelines for disposal.

- > Waste electrical equipment
- > Accessories and spare parts
- > Packaging

W&H course certificate for the user

The user has been trained to use the medical device correctly in accordance with the legal regulations (medical devices marketing regulations, medical devices act). Particular attention has been paid to the chapters on safety notes, start-up, operation, hygiene and maintenance, and service (regular inspections).

Product name	Serial number (SN)
Manufacturer with address	
Distributor with address	

Name of the user	Date of birth and/or personnel number
Hospital/practice/department with address	
Signature of the user	
The signature confirms that the user has been trained to use the medical device and has understood the content.	

Name of the instructor	Date of instruction
Address of the instructor	
Signature of the instructor	



W&H course certificate for the instructor

The user has been trained to use the medical device correctly in accordance with the legal regulations (medical devices marketing regulations, medical devices act). Particular attention has been paid to the chapters on safety notes, start-up, operation, hygiene and maintenance, and service (regular inspections).

Product name	Serial number (SN)
Manufacturer with address	
Distributor with address	



Name of the user	Date of birth and/or personnel number
Hospital/practice/department with address	
Signature of the user	
The signature confirms that the user has been trained to use the medical device and has understood the content.	



Name of the instructor	Date of instruction
Address of the instructor	
Signature of the instructor	

Explanation of warranty terms

This W&H product has been manufactured with great care by highly qualified specialists. A wide variety of tests and controls guarantees faultless operation. Please note that claims under warranty can only be validated when all the directions in the Instructions for Use have been followed.

As the manufacturer, W&H is liable for material or manufacturing defects within a warranty period of 24 months from the date of purchase. Accessories and consumables (universal support, coolant tubing, irrigant support, fuse, locator for foot control, hose clips, mains cable, sterilization cassette) are not covered by the warranty.

We accept no responsibility for damage caused by incorrect handling or by repairs carried out by third parties not authorized to do so by W&H!

Claims under warranty – accompanied by proof of purchase, must be sent to the vendor or to an authorized W&H service partner. The provision of service under warranty extends neither the warranty period nor any other guarantee period.

24 - month warranty

Authorized W&H service partners

Visit W&H on the Internet at <http://wh.com>

You can find your nearest W&H service partner under “Service” in the menu.

If you do not have Internet access, please contact:

W&H (UK) LIMITED, 6 Stroud Wood Business Centre, Park Street, St Albans, Hertfordshire AL2 2NJ, United Kingdom

t + 44 1727 874990, f + 44 1727 872254, E-Mail: technical.uk@wh.com

W&H Impex Inc., 6490 Hawthorne Drive, Windsor, Ontario, N8T 1J9, Canada

t + 1 800 2656277, 1 519 9446739, f + 1 519 9746121, E-Mail: service.ca@wh.com

W&H Impex Inc., 14300 Henn Rd., Dearborn, MI 48126, USA

t + 1 800 2656277, 1 519 9446739, f + 1 519 9746121, E-Mail: service.us@wh.com

A-DEC AUSTRALIA CO. INC., Unit 8, 5-9 Ricketty Street, Mascot NWS 2020, Australia

t + 61 2 83324000, f + 61 2 83324099, E-Mail: a-dec@a-dec.com.au

Manufacturer

W&H Dentalwerk Bürmoos GmbH
Ignaz-Glaser-Straße 53, 5111 Bürmoos, Austria

t +43 6274 6236-0,
office@wh.com

f +43 6274 6236-55
wh.com

Form no. 50873 AEN
Rev. 000 / 15.07.2016
Subject to alterations

