

Dental Catalogue / Catalogo Dentale

Dental Catalogue / Catalogo Dentale

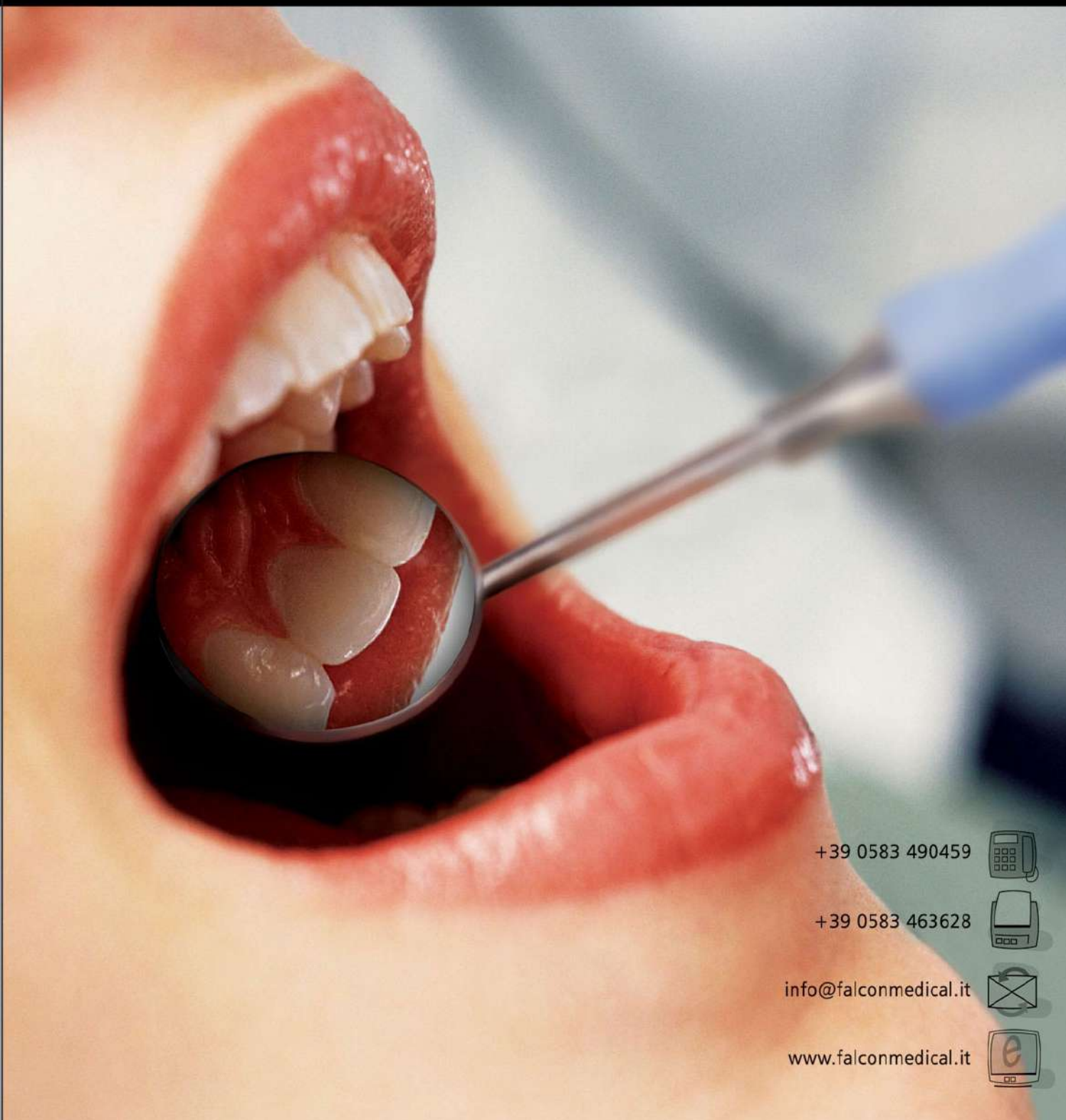

+39 0583 490459



+39 0583 463628



info@falconmedical.it



www.falconmedical.it



Introduction / Introduzione

The Company

Falcon Medical Italia is the Italian daughter company of Falcon Surgical, a leading manufacturer which for over thirty years has specialized in manufacturing instruments for dentistry, dental laboratories, veterinary, surgery and body care.

Thanks to continuous innovation and the use of certified raw materials, Falcon Surgical has been able to develop such a comprehensive variety of instruments as to satisfy the varying and increasingly severe requirements of an international audience both terms of quality and range..

To date Falcon Surgical is present with own subsidiaries in Germany, England, Italy, Poland.

Manufacturing activities.

All Falcon Instruments are made using state of the art materials and manufacturing techniques which extend to the use of sophisticated metals and alloys such as titanium and nichel titanium.

All manufacturing activities are performed under Quality Assurance conditions as laid forth by the EN ISO 2000 norms (all of which has been certified and is being continuously monitored by recognised international bodies) and in compliance with all laws and directives ruling the distribution of Medical Devices..

Quality Guarantee

As a result of the experience accumulated in over three decades and the stringent quality control tests both in production and at the final stages of manufacturing Falcon Surgical is in a position to guarantee a consistent level of quality of any product in their range.

Customer care

Our customer care department will be glad to help vis a vis any request for assistance.

L'azienda

La Falcon Medical Italia è l'emanazione nazionale di un'azienda leader, la Falcon Surgical, che da oltre 30 anni si è specializzata nella produzione di strumenti per odontoiatria, odontotecnica, veterinaria, chirurgia e bodycare.

Grazie ad una continua innovazione e all'utilizzo di materie prime certificate, la Falcon Surgical è riuscita a realizzare una gamma completa di strumentario capace di soddisfare le più sofisticate esigenze di una platea internazionale sia in termini qualitativi che di gamma.

Ad oggi la Falcon Surgical è presente con proprie filiali in Germania, Inghilterra, Italia, Polonia.

La produzione

Tutto lo strumentario Falcon viene prodotto utilizzando materiali e tecniche costruttive allo stato dell'arte che comprendono in alcuni casi metalli o leghe nobili quali (ad esempio) titanio e nichel titanio.

La produzione avviene in regime di Assicurazione Qualità secondo le norme EN ISO 2000 (come certificato e costantemente monitorato dai riconosciuti organismi internazionali preposti) e nel rispetto di tutte le Leggi e Direttive che regolano l'immissione in commercio dei dispositivi medici,

Garanzia di qualità

Grazie ad un'esperienza trentennale ed ai severi controlli in produzione e finali la Falcon Surgical è in grado di assicurare le più ampie garanzie di qualità costante di ogni suo prodotto.

Assistenza clienti

Un servizio clienti sarà comunque a Vostra disposizione per ogni tipo di assistenza o richiesta.



ISO 13485 : 2003



Diagnostic / Diagnostica

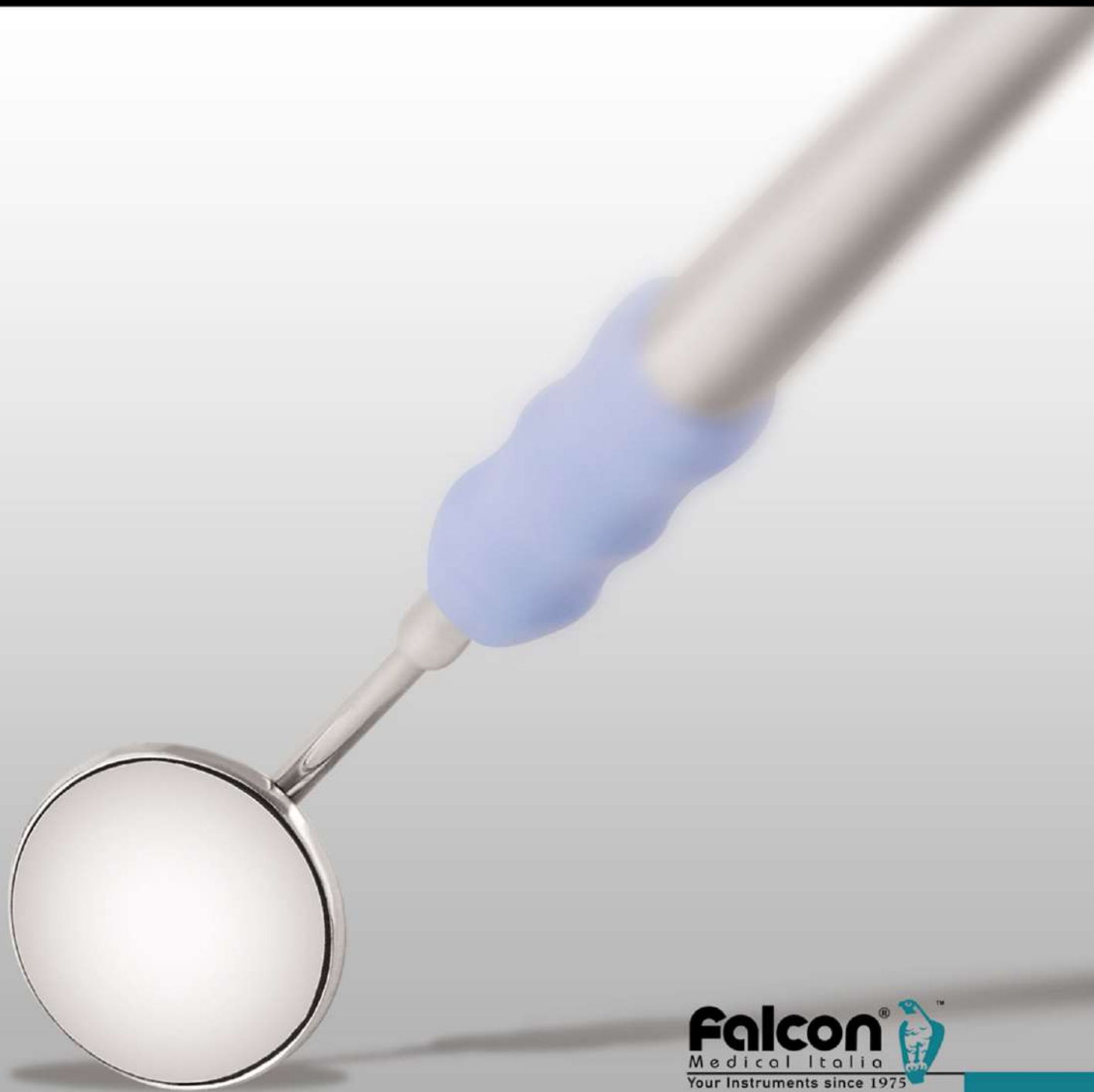

Explorers Double Ended Sonde Doppie



Explorers double ended rigid / Sonde doppie rigide

SOFT LINE INSTRUMENTS
soft and sure grip



Fig. 23/17
DD.154.170
Olive - Yellow / Oliva - Giallo



Fig. 23/17A
DD.154.171
Olive - Yellow / Oliva - Giallo

Explorers double ended rigid / Sonde doppie rigide

Classic Round
6 mm solid handle
Manico pieno da 6mm



Fig. 23/17
DD.150.170



Fig. 23/17A
DD.150.171



Fig. 23/16
DD.150.160

Explorers double ended flexible / Sonde doppie flessibili



Fig. 2
DD.101.020



Fig. 3
DD.101.030



Fig. 5
DD.101.050



Fig. TU17/23
DD.181.023



Fig. 6/23
DD.151.623



DD.160.170
Pack of 5 explorers Fig. 23/17 / Confezione di 5 sonde Fig. 23/17



DD.161.050
Pack of 5 explorers Fig. 5 / Confezione di 5 sonde Fig. 5



Explorers single ended rigid
Sonde singole rigide

Classic Round 6 mm solid handle
Manico pieno da 6mm



Pack of 5 explorers / Confezione di 5 sonde

- DD.313.060 Fig. 6
- DD.313.090 Fig. 9
- DD.313.110 Fig. 11
- DD.313.160 Fig. 16
- DD.313.230 Fig. 23

Explorers single ended flexible
Sonde singole flessibili

Classic Round 6 mm solid handle
Manico pieno da 6mm



Pack of 5 explorers / Confezione di 5 sonde

- DD.211.060 Fig. 6
- DD.211.061 Fig. 6A
- DD.211.090 Fig. 9
- DD.211.230 Fig. 23
- DD.211.320 Fig. 32

Explorers Single Ended Sonde Single

Explorers single ended rigid
Sonde singole rigide



SOFT LINE INSTRUMENTS
soft and sure grip

All Soft-Line instruments are made of Stainless Steel and Silicone, these can be autoclaved, chemically cleaned, ultrasonically cleaned and sterilized by cold or dry heat method.

Tutti gli strumenti 'Soft Line' sono prodotti in acciaio Inox e possono essere lavati in ultrasuoni, Sterilizzati a freddo, in camera calda a secco, in autoclave o chemiclave.



Explorers single ended rigid
Sonde singole rigide



Classic-8
4,5 mm solid handle
Manico pieno da 4,5 mm





Color Coded

Expro (explorer-probe combination) / Expro (combinazione sonda / sonda millimetrica)



Fig. 11/23
DD.451.113



Fig. 12/23
DD.451.123



Fig. 23 /WHO
DD.451.230



Fig. 23 /GF
DD.451.233 Goldman-Fox



Fig. 23 /M
DD.451.235 Michigan

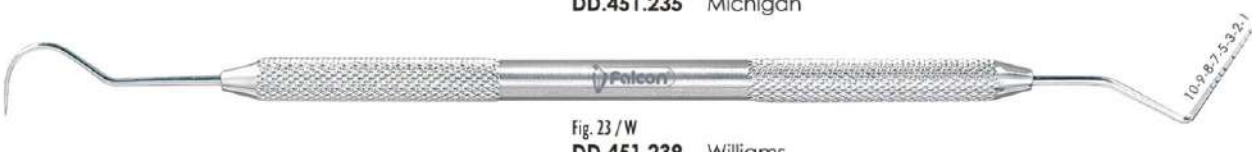

Fig. 23 /W
DD.451.239 Williams



Fig. 23 /W
DD.454.239 Williams
Olive - Yellow / Oliva - Giallo

Probes double ended / Sonde doppie millimetriche



Fig. U 1/2
DD.550.032 Cattoni



Fig. 1N
DD.601.141 Nabers



Fig. 2N
DD.601.142 Nabers

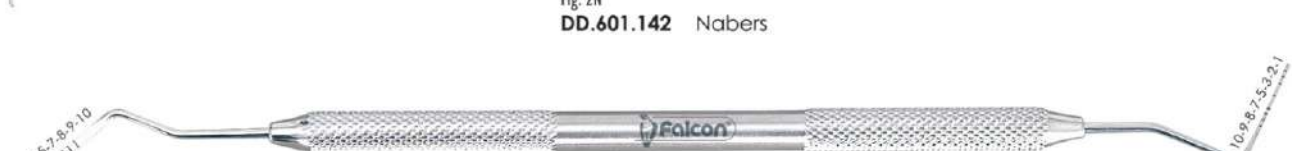

Fig. W /GF
DD.601.233 Williams / Goldman-Fox

1-2-3-5-7-8-9-10
311-1-1111

Diagnostic

Color Coded



D-Lite

ILLUMINATED Mouth Mirror

Specchietto Illuminato



- LED bright white light
- Greater visibility
- Simple and convenient to use
- Autoclavable

- Intensa luce bianca a LED
- Maggiore visibilità
- Semplice e pratico da usare
- Autoclavabile



Single-Use Mirrors

Eliminates the risk of cross contamination between patients

Specchietti monouso

Eliminano la possibilità di contagio incrociato tra pazienti



DD.035.010

Pack of 25 pieces

Cold sterilization only

Confezione di 25 pezzi

Solo sterilizzazione a freddo



DD.035.000

Complete with 3 sets of batteries

Corredo di 3 sets di batterie

DD.035.020

Spare batteries set (3 pieces per set)

Set batterie di ricambio (3 pezzi per set)

Introducing Falcon SS-200 Mouth Mirrors
Gli Specchietti Falcon SS-200

Key features

- Made of 18-8 stainless steel
- Sterilizable up to 200° C
- Best reflection and image quality
- Wide variety

Caratteristiche

- Prodotti con acciaio Inox 18-8
- Sterilizzabili fino a 200° C.
- Qualità superiore per immagine e riflessione
- Vasta gamma



Anatomy of SS-200 mirrors
Anatomia degli specchietti SS-200

High quality mirror, Made in U.S.A.
Vetro di elevata qualità prodotto negli USA

Silicone sheet autoclavable upto 200°C
Guarnizione in silicone autoclavabile fino a 200°C

Stainless steel 18-8 body
Carcassa in acciaio Inox 18-8

Coating can withstand temperature upto 200° C
Argentatura in grado di sopportare temp. fino a 200° C.

Silicone sheet for sealing
Guarnizione sigillante

Difference between rear and front surface mirrors
Differenza tra riflessione frontale e dorsale

Rear surface mirror
Specchietto a riflessione dorsale

Double reflection
Doppia riflessione

Single reflection / Riflessione unica
Sharp image quality / Immagine nitida

Front surface mirror
Specchietto a riflessione frontale

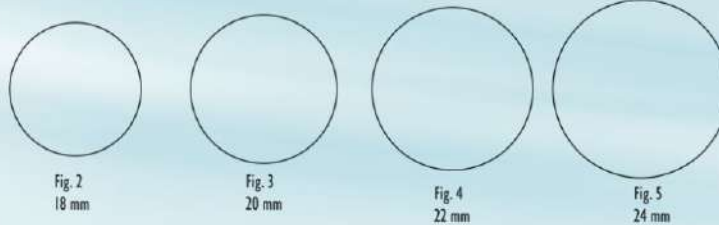

SS-200 Mirrors		Pack of 12 / Conf. 12 pz.			
		Front surface / Riflessione frontale		Rear surface / Riflessione dorsale	
Fig.	Ø mm	Rhodium / Rodiato	Chrome / Cromato	Magnifying / Concavo	Plane / Piano
2	18	-	-	DD.506.020	DD.509.020
3	20	-	-	DD.506.030	DD.509.030
4	22	DD.501.040	DD.503.040	DD.506.040	DD.509.040
5	24	DD.501.050	DD.503.050	DD.506.050	DD.509.050

SS-200 Perfection



- Rhodium coated front surface mirror
- Wide stem offers comfortable cheek retraction
- Non glare satin finish
- Specchietto rodiato per riflessione frontale
- Stelo largo funge da retrattore
- Satinato per evitare riflessi di luce



Fig. 4 DD.515.040 Ø 22 mm
Fig. 5 DD.515.050 Ø 24 mm

Micro mirrors, rhodium front surface
Micro specchietti, rodiato per riflessione frontale



Fig. 000 DD.494.000 Ø 10 mm
Fig. 00 DD.495.000 Ø 12 mm

Micro mirrors stainless steel, double sided
Micro specchietti bilaterali in acciaio inox



Ø 3 mm DD.485.030
Ø 5 mm DD.485.050
2.5 x 9 mm DD.484.025
4 x 10 mm DD.484.040



BEST SELLER



Mirror handles solid / Manici pieni per specchietto



Mirror handles hollow / Manici vuoti per specchietto



SOFT LINE INSTRUMENTS
soft and sure grip



Mirror handles hollow / Manici vuoti per specchietto



DD.522.015
Pack of 5 pieces / Confezione di 5 pezzi



DD.540.015
Pack of 5 pieces / Confezione di 5 pezzi



DD.545.015
Pack of 5 pieces / Confezione di 5 pezzi



DD.526.000
Pack of 5 pieces / Confezione di 5 pezzi

Micro scalpels and micro mirror handles / Manici per micro lame e per micro specchietti



LED examination light / Luce per esame



Non autoclavable / Non autoclavabile

Intraoral Photographic Mirrors
Specchi Per Foto Intraorali



Made of stainless steel
 Realizzati in acciaio inox

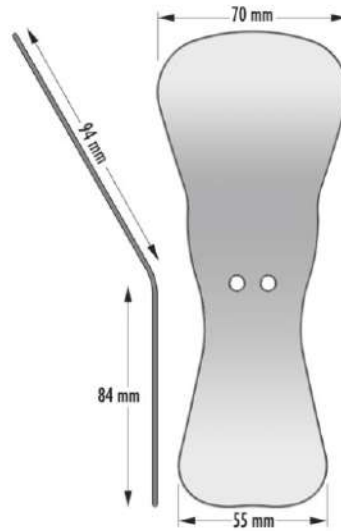

DD.468.010
 Adult palatal / child palatal
 Occlusale per adulto e bambino

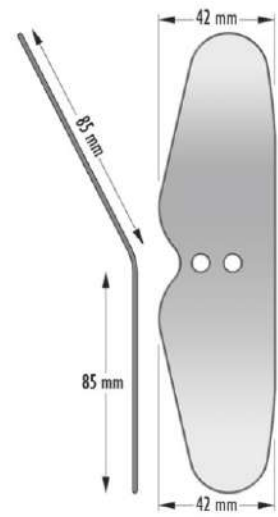

DD.468.020
 Buccal
 Laterale

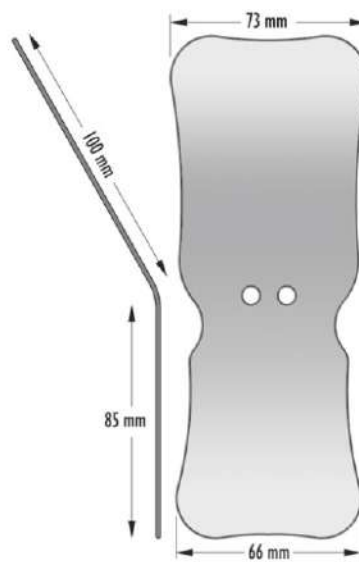

DD.468.030
 Adult palatal / child palatal
 Occlusale per adulto e bambino

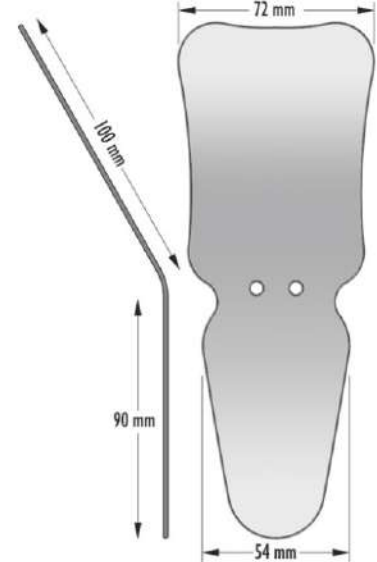

DD.468.040
 Adult palatal / adult buccal
 Occlusale / laterale per Adulto

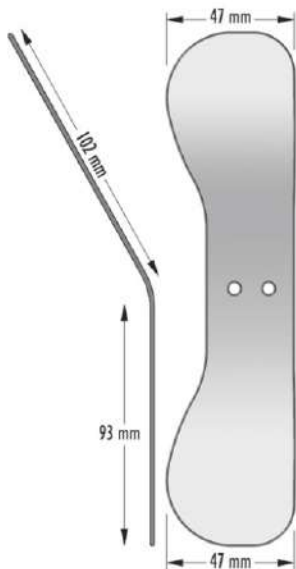

DD.468.050
 Lingual upper / lingual lower
 Linguale superiore / Inferiore

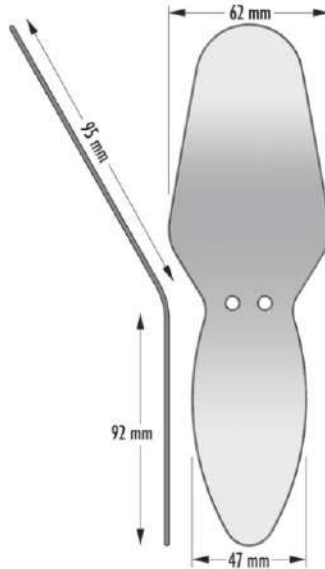

DD.468.060
 Adult buccal / child buccal
 Laterale per adulto e bambino

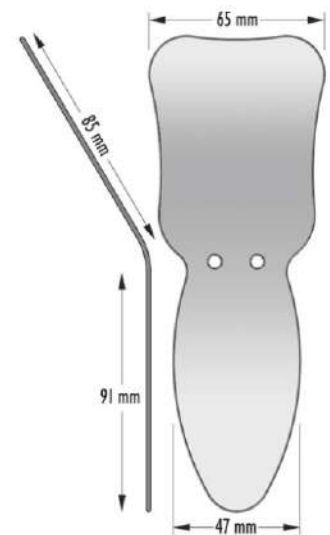

DD.468.070
 Child palatal / child buccal
 Occlusale / laterale per bambino



DD.470.010
Buccal
Laterale



DD.470.020
Lingual
Linguale



DD.470.030
Palatal adult - Standard
Occlusale adulto - Standard

- Double sided front surface
- No double reflection
- Chromium coated glass
- Provides sharp images

- Bilaterali a riflessione frontale
- Evitano la doppia riflessione
- In vetro cromato
- Immagini ad elevata risoluzione



DD.470.031
Palatal adult - Maxi
Occlusale adulto - Maxi



DD.470.040
Palatal-child
Occlusale bambino

Intraoral photographic mirrors stainless steel
Specchi per foto intraorali in acciaio inox



DD.469.010
Buccal
Laterale



DD.469.020
Lingual
Linguale



DD.469.030
Palatal-adult
Occlusale adulto



DD.469.040
Palatal-child
Occlusale bambino

Handle for photographic mirrors
Manico per specchi per foto intraorali



Designed by / Modello
FALCON®

Stainless Steel
In acciaio Inox

Titanium Nitride Coated
Rivestimento in nitruro di titanio



Bendable photographic large mirrors
Specchietti grandi orientabili per foto intraorali

- Bendable at any angle
 - Front surface
 - No double reflection
 - Chromium coated glass
 - Provides sharp images
 - Autoclavable
- Totalmente orientabili
 - Riflessione frontale
 - Evitano la doppia riflessione
 - In vetro cromato
 - Immagini ad elevata risoluzione
 - Autoclavabili

DD.471.010 Ø 38mm
DD.471.020 Ø 50mm



DD.472.000

Deluxe tweezers / Pinzette deluxe

**Titanium
Titanio**

Made of 18-8 non-magnetic stainless steel / Realizzate in acciaio antimagnetico 18-8



DD.890.010 College 150 mm	DD.900.150 College 150 mm	DD.901.150 Meriam 150 mm	DD.909.050 College 150 mm	DD.929.050 College-Locking 150 mm	DD.934.010 Flagg 160 mm	DD.944.010 Meriam 160 mm	DD.978.130 Perry 130 mm	DD.979.130 Perry 130 mm	DD.909.055 College DD.934.015 Flagg DD.944.015 Meriam
--	--	---------------------------------------	--	--	--------------------------------------	---------------------------------------	--------------------------------------	--------------------------------------	--

Tweezers / Pinzette

Made of magnetic stainless steel / Realizzate in acciaio magnetico

**Tweezers / Pinzette
TOE (Turn over ends)**

Absence of welding leads to:
Higher corrosion resistance
Easier to clean

Assenza della saldatura comporta:
Piu' elevata resistenza alla corrosione
Piu' facili da pulire



DD.910.050 College 150 mm	Fig. 8 DD.920.010 College 150 mm	DD.930.050 College - Locking 150 mm	DD.935.010 Flagg 160 mm	DD.945.010 Meriam 160 mm	DD.980.130 Perry 130 mm	DD.911.050 College TOE 150 mm	DD.946.010 Meriam TOE 160 mm
--	---	--	--------------------------------------	---------------------------------------	--------------------------------------	--	---

Diagnostic



DD.996.061

Contents / Contenuto

- DD.909.050** Tweezers College
Pinzetta College
- DD.522.010** Mirror handle
Manico per specchietto
- DD.509.040** Plane mouth mirror fig. 4
Specchietto piano fig. 4
- DD.201.061** Explorer flexible fig. 6A
Sonda flessibile fig. 6A



DD.996.090

Contents / Contenuto

- DD.909.050** Tweezers College
Pinzetta College
- DD.522.010** Mirror handle
Manico per specchietto
- DD.509.040** Plane mouth mirror fig. 4
Specchietto piano fig. 4
- DD.201.090** Explorer flexible fig. 9
Sonda flessibile fig. 9



DD.996.230

Contents / Contenuto

- DD.909.050** Tweezers College
Pinzetta College
- DD.522.010** Mirror handle
Manico per specchietto
- DD.509.040** Plane mouth mirror fig. 4
Specchietto piano fig. 4
- DD.201.230** Explorer flexible fig. 23
Sonda flessibile fig. 23



DD.997.060

Contents / Contenuto

- DD.909.050** Tweezers College
Pinzetta College
- DD.522.010** Mirror handle
Manico per specchietto
- DD.509.040** Plane mouth mirror fig. 4
Specchietto piano fig. 4
- DD.303.060** Explorer rigid fig. 6
Sonda rigida fig. 6



DD.997.090

Contents / Contenuto

- DD.909.050** Tweezers College
Pinzetta College
- DD.522.010** Mirror handle
Manico per specchietto
- DD.509.040** Plane mouth mirror fig. 4
Specchietto piano fig. 4
- DD.303.090** Explorer rigid fig. 9
Sonda rigida fig. 9



DD.997.230

Contents / Contenuto

- DD.909.050** Tweezers College
Pinzetta College
- DD.522.010** Mirror handle
Manico per specchietto
- DD.509.040** Plane mouth mirror fig. 4
Specchietto piano fig. 4
- DD.303.230** Explorer rigid fig. 23
Sonda rigida fig. 23



DD.998.230

Contents / Contenuto

- DD.900.150** Tweezers ergonomic College
Pinzetta ergonomico College
- DD.526.020** Soft-Line mirror handle
Manico per specchietto "Soft-Line"
- DD.515.040** Rhodium mouth mirror perfection model fig. 4
Specchietto rodriato mod. perfection fig. 4
- DD.304.230** Soft-Line explorer fig. 23
Sonda "Soft-Line" fig. 23





X-Ray positioner kits / Kit centratore

Anterior Blue
Anteriori-Blu



DD.1201.00

Contents / Contenuto:
 1 x Indicator arm / Braccetto indicatore
 1 x Aiming ring / Anello di centraggio
 1 x Film holder / Portalastrine

Posterior Yellow
Posteriori Giallo



DD.1202.00

Contents / Contenuto:
 1 x Indicator arm / Braccetto indicatore
 1 x Aiming ring / Anello di centraggio
 1 x Film holder / Portalastrine

Bite-Wing Red
Bite-Wing Rosso



DD.1203.00

Contents / Contenuto:
 1 x Indicator arm / Braccetto indicatore
 1 x Aiming ring / Anello di centraggio
 1 x Film holder / Portalastrine



Endo Green
Endo Verde



DD.1206.00

Contents / Contenuto:
 1 x Indicator arm / Braccetto indicatore
 1 x Aiming ring / Anello di centraggio
 1 x Film holder / Portalastrine



X-Ray illuminators / Negativoscopi



X-Ray illuminator dental small
Negativoscopio dentale - piccolo

DQ.8000.01
150 x 250 mm



X-Ray illuminator dental medium
Negativoscopio dentale medio

DQ.8005.01
190 x 330 mm



X-Ray illuminator telepanoramic
Negativoscopio telepanoramico

DQ.8010.01
250 x 330 mm



X-Ray illuminator tomography
Negativoscopio per tomografia

DQ.8015.01
380 x 480 mm

Periodontal / Parodontologia



Ultrasonic Tips / Punta per Ultrasuoni

Ultrasonic scaling tips / Punta per ablazione



Type / Tipo E

Type / Tipo S



G1

DP.005.010

DP.006.010



G2

DP.005.020

DP.006.020



G3

DP.005.030

DP.006.030



G4

DP.005.040

DP.006.040



G5

DP.005.050

DP.006.050



G6

DP.005.060

DP.006.060

Ultrasonic periodontal tips / Punta per parodontologia

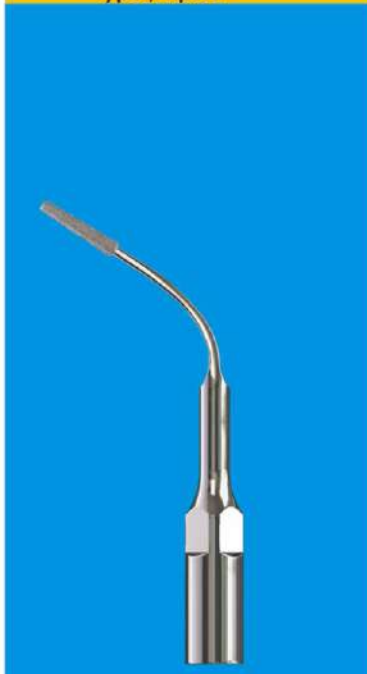

Type / Tipo E

Type / Tipo S



P3D

DP.009.030

DP.010.030



Diamond Coated
Punte Diamantate



P4D

DP.009.040

DP.010.040



P1

DP.007.010

DP.008.010



P3

DP.007.030

DP.008.030



P4

DP.007.040

DP.008.040

Accessories / Accessori



135° C
Autoclavable
Autoclavabile



Torque wrench / Chiave tubolare
DP.004.010



Tips holder / Porta punta
DP.004.020



Tightening key / Chiave di serraggio
DP.005.000



Quick connector / Attacco rapido
DP.004.030



Gracey Curettes Curette di Gracey

- Ergonomic, large diameter silicone handle for better grip
- Ultra light weight
- Special grade stainless steel tips ensure longer life
- Rigid pattern, thicker tips than standard Gracey
- Manico ergonomic di grosso diam., in silicone, per maggior grip
- Ultraleggere
- Uso di speciale a. inox assicura elevata longevità
- Punta rigide piu' robuste delle Gracey standard



Anterior teeth
Denti anteriori



Fig. 1/2
DP.156.021 rigid
DP.160.021 standard
Grey / Grigio



Anterior teeth
Denti anteriori



Fig. 3/4
DP.156.041 rigid
DP.160.041 standard
Black / Nero

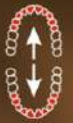

Anterior and Premolars
Denti anteriori e Premolari



Fig. 5/6
DP.156.061 rigid
DP.160.061 standard
Yellow / Giallo



Premolars and Molars
Denti Premolari e Molari



Fig. 7/8
DP.156.081 rigid
DP.160.081 standard
Green / Verde



Molars buccal and lingual surfaces
Molari, superfici buccali e linguali



Fig. 9/10
DP.156.101 rigid
DP.160.101 standard
Red / Rosso



Posterior mesial surfaces
Superfici mesiali posteriori



Fig. 11/12
DP.156.111 rigid
DP.160.111 standard
Orange / Arancione



Posterior distal surfaces
Superfici distali posteriori



Fig. 13/14
DP.156.141 rigid
DP.160.141 standard
Blue / Blu



DP.156.000 rigid
Set of 7 pieces / Serie da 7 pezzi



DP.999.011 standard
Set of 7 pieces / Serie da 7 pezzi

SOFT LINE INSTRUMENTS
soft and sure grip

135° C
Autoclavabile
Autoclavabile



Fig. 1/2
DP.160.024
Grey / Grigio

Anterior teeth
Denti anteriori



Fig. 3/4
DP.160.044
Black / Nero

Anterior teeth
Denti anteriori



Fig. 5/6
DP.160.064
Yellow / Giallo

Anterior and Premolars
Denti anteriori e Premolari



Fig. 7/8
DP.160.084
Green / Verde

Premolars and Molars
Denti Premolari e Molari



Fig. 9/10
DP.160.104
Red / Rosso

Molars buccal and lingual surfaces
Molari, superfici buccali e linguali



Fig. 11/12
DP.160.114
Orange / Arancione

Posterior mesial surfaces
Superfici mesiali posteriori



Fig. 13/14
DP.160.144
Blue / Blu

Posterior distal surfaces
Superfici distali posteriori



Fig. 15/16
DP.160.164
Coffee / Caffè

Posterior mesial surfaces
Superfici mesiali posteriori



Fig. 17/18
DP.160.184
Light Blue / Celeste

Posterior distal surfaces
Superfici distali posteriori



Fig. 11/14
DP.160.124
Orange-Blue / Arancione-Blu

Mesial/Distal surfaces
Superfici mesiali/distali



Fig. 12/13
DP.160.134
Orange-Blue / Arancione-Blu

Mesial/Distal surfaces
Superfici mesiali/distali



DP.999.014
Set of 7 pieces / Serie da 7 pezzi
Contents / Contenuto
Fig. 1/2, 3/4, 5/6, 7/8, 9/10, 11/12, 13/14



ClassicRound 6 mm solid handle
Manico pieno da 6mm



CLASSIC-LITE 8 mm hollow handle
Manico vuoto da 8 mm

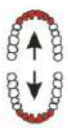

Anterior teeth
Denti anteriori

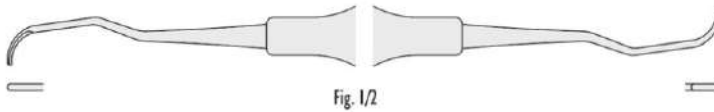
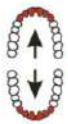

Fig. 1/2



Anterior teeth
Denti anteriori

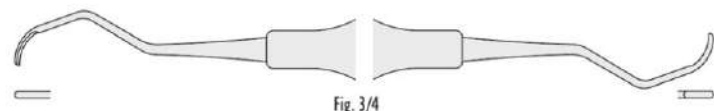
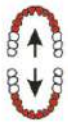

Fig. 3/4



Anterior and
Premolars
Denti anteriori
e Premolari

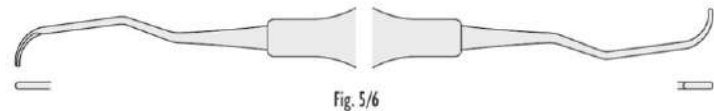
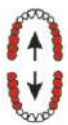

Fig. 5/6



Premolars and
Molars
Denti Premolari
e Molari

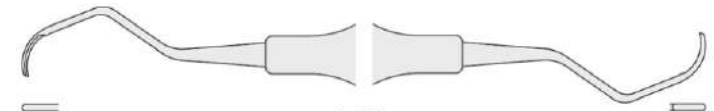
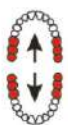

Fig. 7/8



Molars buccal and
lingual surfaces
Molari, superfici
boccali e linguali

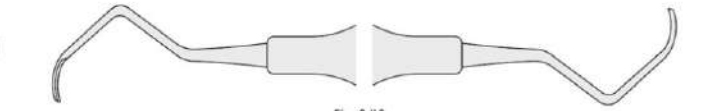
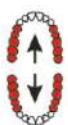

Fig. 9/10



Posterior mesial
surfaces
Superfici mesiali
posteriori

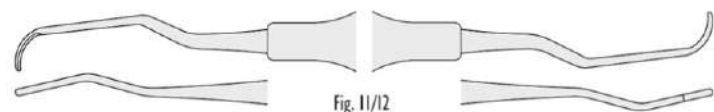
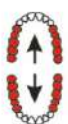

Fig. 11/12



Posterior distal
surfaces
Superfici distali
posteriori

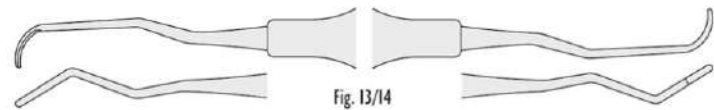

Fig. 13/14

	ClassicRound	CLASSIC-LITE
Fig. 1/2	DP.160.020	DP.160.025
Fig. 3/4	DP.160.040	DP.160.045
Fig. 5/6	DP.160.060	DP.160.065
Fig. 7/8	DP.160.080	DP.160.085
Fig. 9/10	DP.160.100	DP.160.105
Fig. 11/12	DP.160.110	DP.160.115
Fig. 13/14	DP.160.140	DP.160.145

ClassicRound



DP.999.015
Gracey set of 7 pieces
Gracey serie da 7 pezzi

CLASSIC-LITE



DP.999.020
Gracey set of 7 pieces
Gracey serie da 7 pezzi

Periodontal

Periodontal chisels / Scalpelli per parodontologia



Universal curettes / Curettes universali

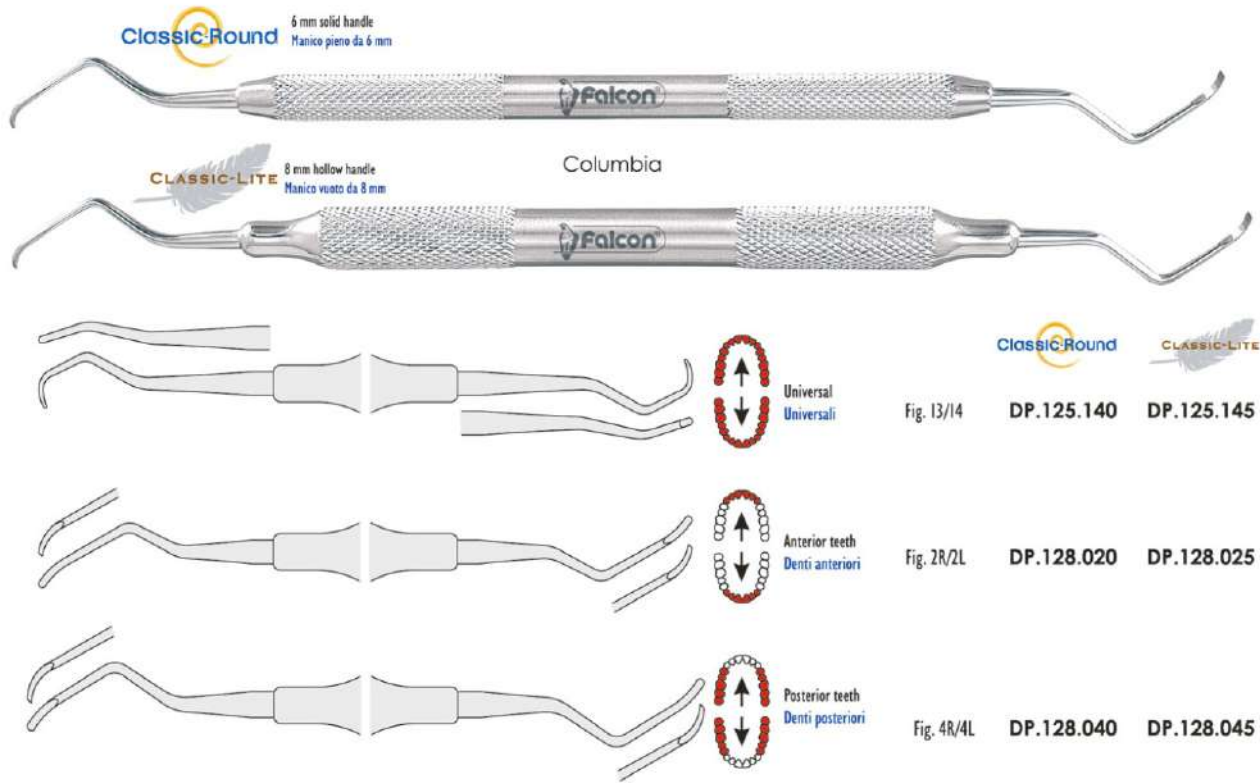

Hoe scalars / Curette sopra-gengivali a "zappa"

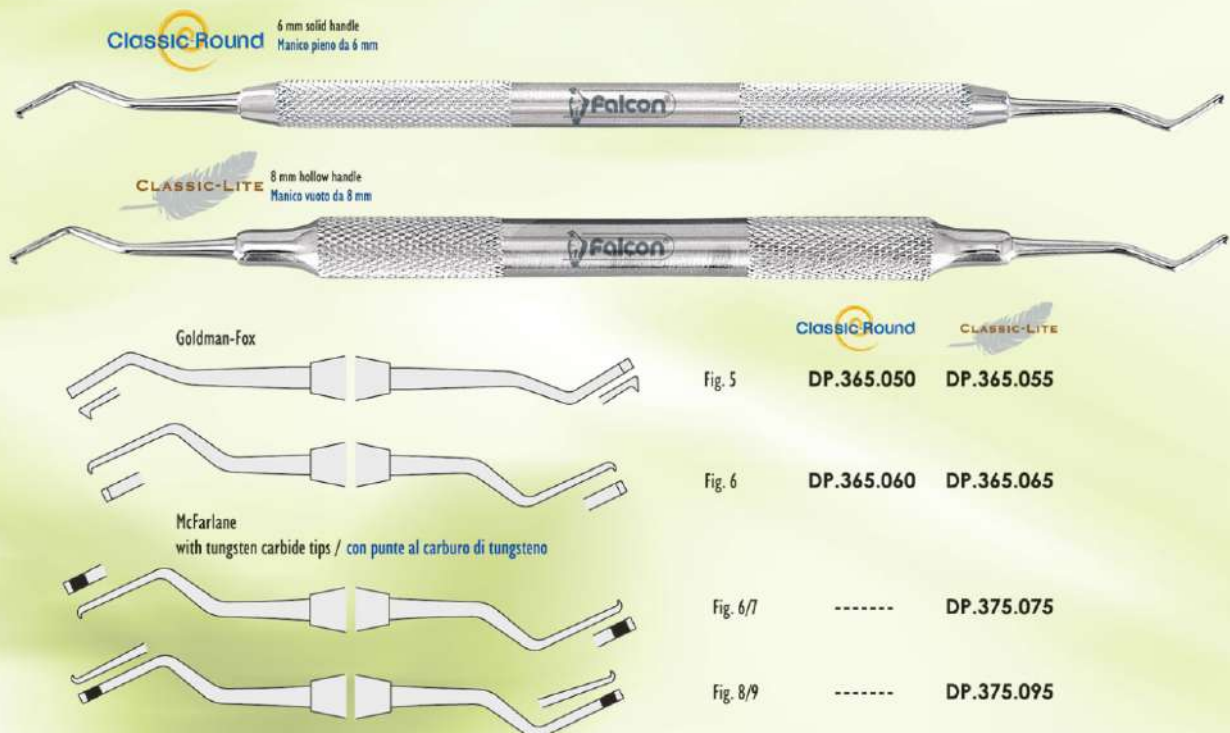



SOFT LINE INSTRUMENTS
soft and sure grip

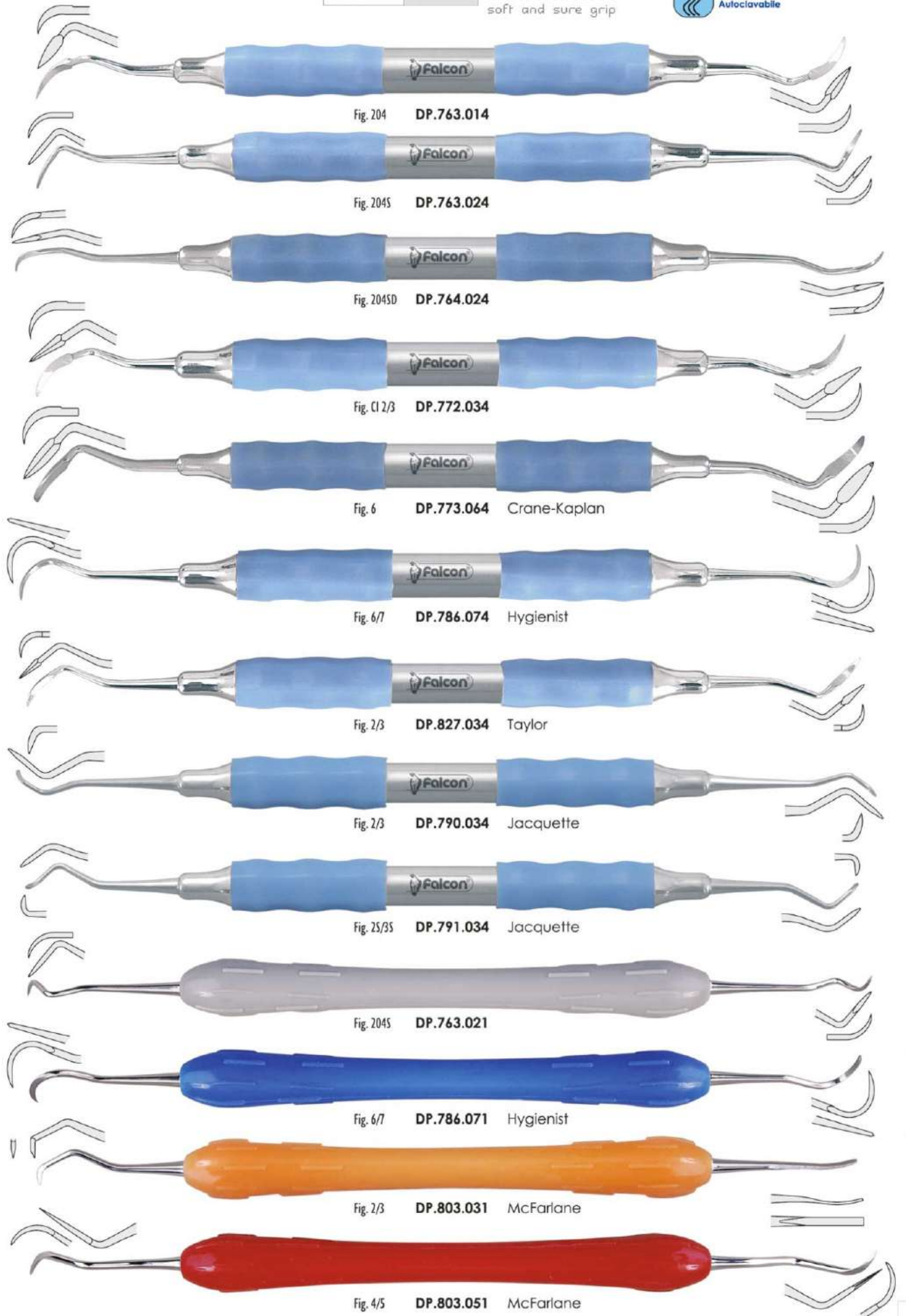

Fig. 204 DP.763.014

Fig. 204S DP.763.024

Fig. 204SD DP.764.024

Fig. Cl 2/3 DP.772.034

Fig. 6 DP.773.064 Crane-Kaplan

Fig. 6/7 DP.786.074 Hygienist

Fig. 2/3 DP.827.034 Taylor

Fig. 2/3 DP.790.034 Jacquette

Fig. 2S/3S DP.791.034 Jacquette

Fig. 204S DP.763.021

Fig. 6/7 DP.786.071 Hygienist

Fig. 2/3 DP.803.031 McFarlane

Fig. 4/5 DP.803.051 McFarlane

Periodontal

Classic-Round 6 mm solid handle
Manico pieno da 6mm

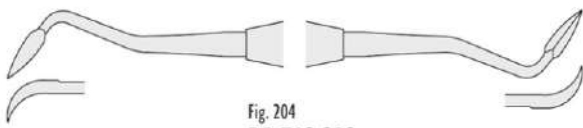

Fig. 204
DP.763.010

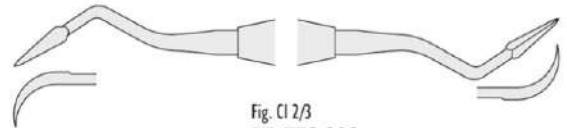

Fig. CI 2/3
DP.772.030

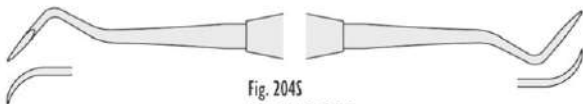

Fig. 204S
DP.763.020

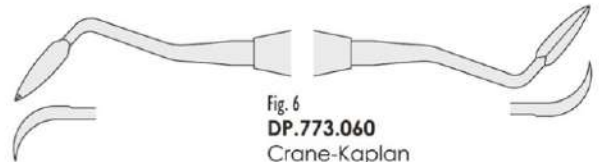

Fig. 6
DP.773.060
Crane-Kaplan

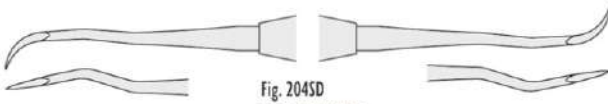

Fig. 204SD
DP.764.020

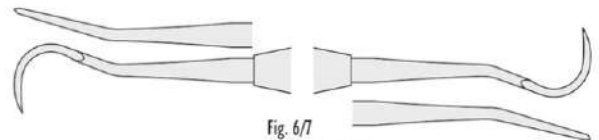

Fig. 6/7
DP.786.070
Hygienist

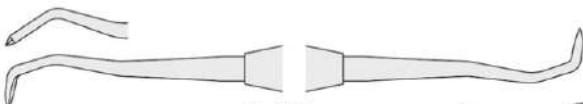

Fig. 31/32
DP.792.320
Jacquette

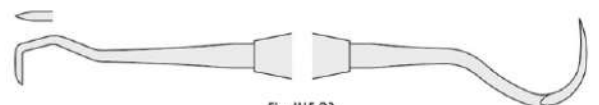

Fig. UI15/33
DP.793.050
Jacquette/Towner

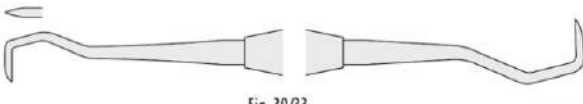

Fig. 30/33
DP.792.330
Jacquette

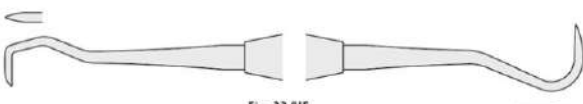

Fig. 33/H5
DP.793.020
Jacquette

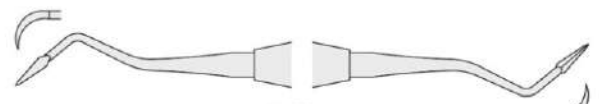

Fig. 2/3
DP.827.030
Taylor

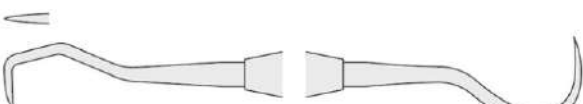

Fig. UI15/30
DP.793.040
Jacquette/Towner

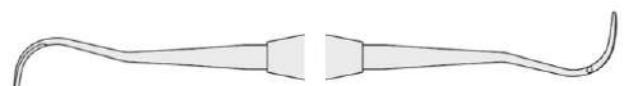

Fig. 7/8
DP.835.080
Younger-Good



CLASSIC-LITE 8 mm hollow handle
Manico vuoto da 8 mm

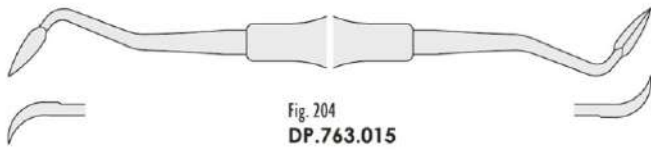

Fig. 204
DP.763.015

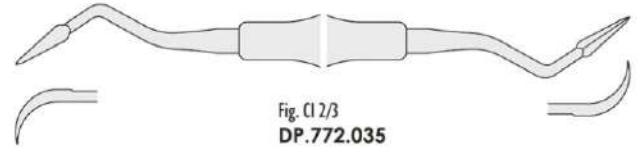

Fig. C1 2/3
DP.772.035

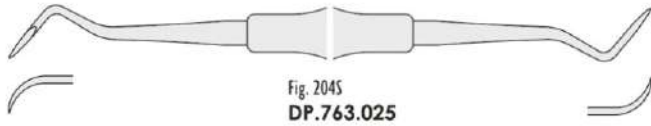

Fig. 204S
DP.763.025

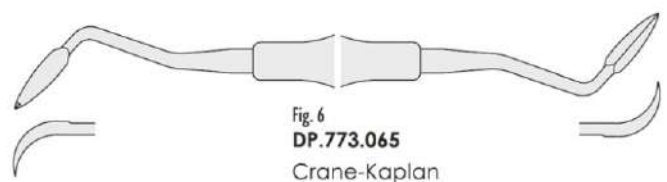

Fig. 6
DP.773.065
Crane-Kaplan

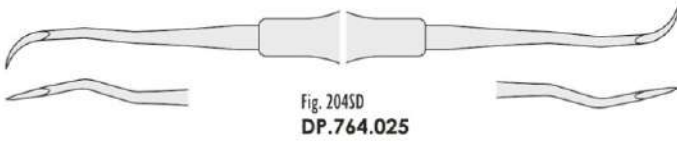

Fig. 204SD
DP.764.025

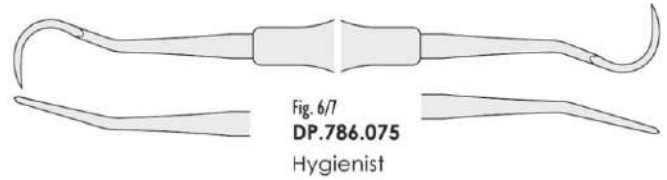

Fig. 6/7
DP.786.075
Hygienist

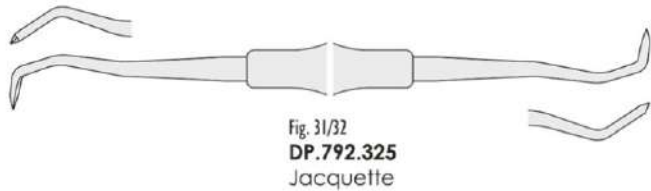

Fig. 31/32
DP.792.325
Jacquette

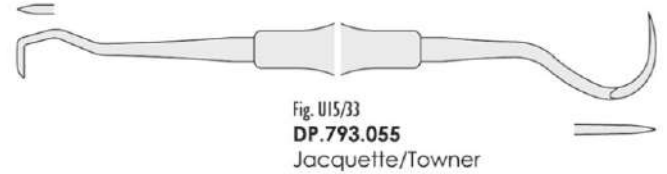

Fig. U15/33
DP.793.055
Jacquette/Towner

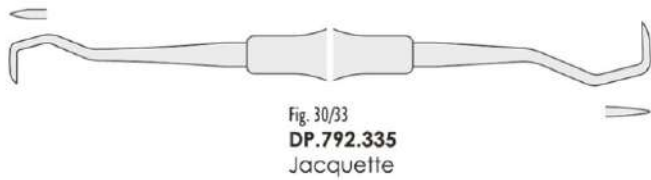

Fig. 30/33
DP.793.335
Jacquette



Fig. 33/H5
DP.793.025
Jacquette

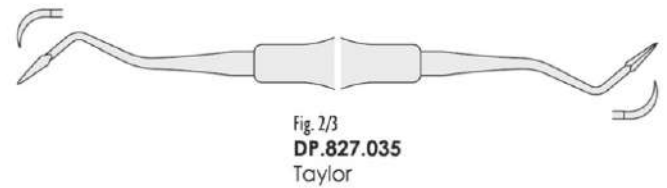

Fig. 2/3
DP.827.035
Taylor

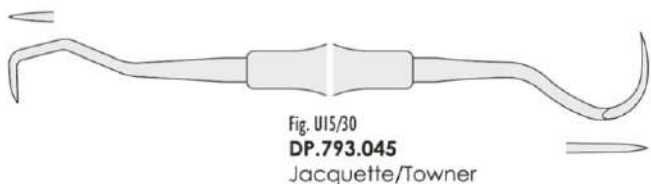

Fig. U15/30
DP.793.045
Jacquette/Towner



Fig. 7/8
DP.835.085
Younger-Good

Classic-8

5.5 mm solid handle
 Manico pieno da 5.5 mm



Darby Perry

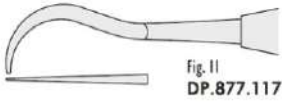

Standard

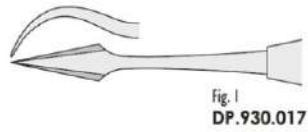

Standard



Falcon Polska



Hygienist

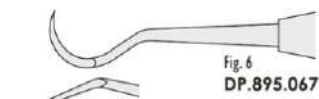
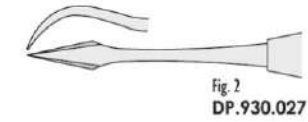

Jacquette

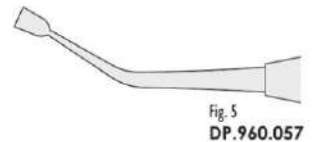
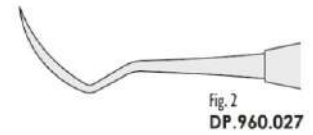
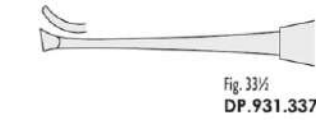
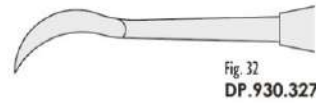
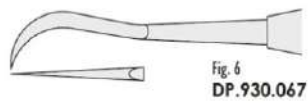
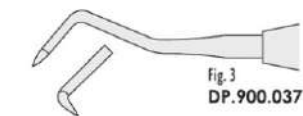
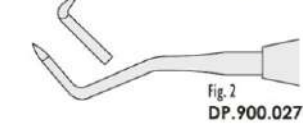

Towner

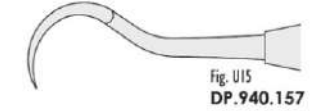

CLASSIC-LITE

8 mm hollow handle
 Manico vuoto da 8 mm



Hygienist

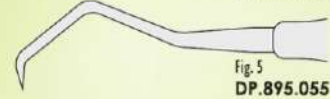

Jacquette

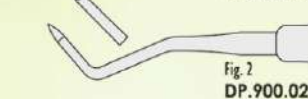
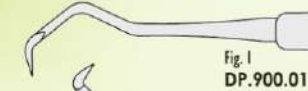

Towner

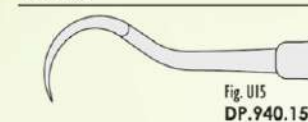

Standard



Standard

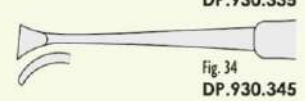
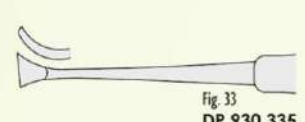

Endodontics / Endodonzia

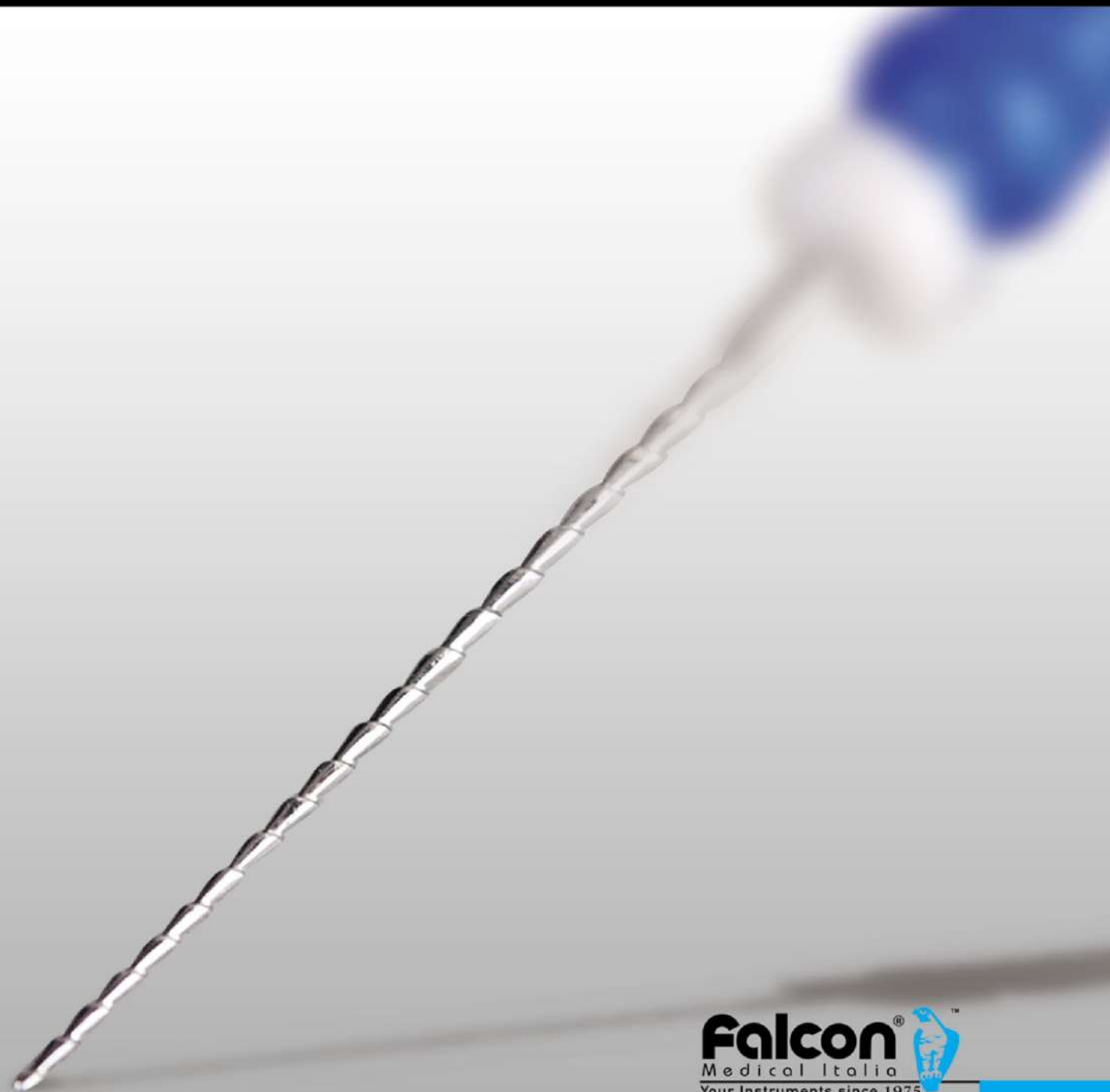

Endodontic Instruments / Strumenti Canalari



NiTi endodontic files / Lime canalari NiTi



NiTi Hedstrom files
Lime NiTi tipo Hedstrom

Pack of 6 pcs. / Conf. 6 pz.

ISO Color / No	21 mm	25 mm	28 mm
08	DR.3011.08	DR.3012.08	DR.3013.08
10	DR.3011.10	DR.3012.10	DR.3013.10
15	DR.3011.15	DR.3012.15	DR.3013.15
20	DR.3011.20	DR.3012.20	DR.3013.20
25	DR.3011.25	DR.3012.25	DR.3013.25
30	DR.3011.30	DR.3012.30	DR.3013.30
35	DR.3011.35	DR.3012.35	DR.3013.35
40	DR.3011.40	DR.3012.40	DR.3013.40
45	DR.3011.45	DR.3012.45	DR.3013.45
50	DR.3011.50	DR.3012.50	DR.3013.50
55	DR.3011.55	DR.3012.55	DR.3013.55
60	DR.3011.60	DR.3012.60	DR.3013.60
70	DR.3011.70	DR.3012.70	DR.3013.70
80	DR.3011.80	DR.3012.80	DR.3013.80
Assorted (6 pcs/pack) / Conf.6 pz.(assortiti)			
15-40	DR.3011.00	DR.3012.00	DR.3013.00
45-80	DR.3011.01	DR.3012.01	DR.3013.01

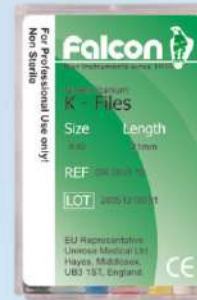

NiTi K-files
Lime NiTi tipo K

Pack of 6 pcs. / Conf. 6 pz.

ISO Color / No	21 mm	25 mm	28 mm
08	DR.3001.08	DR.3002.08	DR.3003.08
10	DR.3001.10	DR.3002.10	DR.3003.10
15	DR.3001.15	DR.3002.15	DR.3003.15
20	DR.3001.20	DR.3002.20	DR.3003.20
25	DR.3001.25	DR.3002.25	DR.3003.25
30	DR.3001.30	DR.3002.30	DR.3003.30
35	DR.3001.35	DR.3002.35	DR.3003.35
40	DR.3001.40	DR.3002.40	DR.3003.40
45	DR.3001.45	DR.3002.45	DR.3003.45
50	DR.3001.50	DR.3002.50	DR.3003.50
55	DR.3001.55	DR.3002.55	DR.3003.55
60	DR.3001.60	DR.3002.60	DR.3003.60
70	DR.3001.70	DR.3002.70	DR.3003.70
80	DR.3001.80	DR.3002.80	DR.3003.80
Assorted (6 pcs/pack) / Conf.6 pz.(assortiti)			
15-40	DR.3001.00	DR.3002.00	DR.3003.00
45-80	DR.3001.01	DR.3002.01	DR.3003.01

Stainless steel endodontic files / Lime canalari in acciaio inox



Stainless steel Hedstrom files
Lime in acciaio inox tipo Hedstrom

Pack of 6 pcs. / Conf. 6 pz.



ISO Color / No	21 mm	25 mm	28 mm
10	DR.3061.10	DR.3062.10	DR.3063.10
15	DR.3061.15	DR.3062.15	DR.3063.15
20	DR.3061.20	DR.3062.20	DR.3063.20
25	DR.3061.25	DR.3062.25	DR.3063.25
30	DR.3061.30	DR.3062.30	DR.3063.30
35	DR.3061.35	DR.3062.35	DR.3063.35
40	DR.3061.40	DR.3062.40	DR.3063.40
45	DR.3061.45	DR.3062.45	DR.3063.45
50	DR.3061.50	DR.3062.50	DR.3063.50
55	DR.3061.55	DR.3062.55	DR.3063.55
60	DR.3061.60	DR.3062.60	DR.3063.60
70	DR.3061.70	DR.3062.70	DR.3063.70
80	DR.3061.80	DR.3062.80	DR.3063.80
Assorted (6 pcs/pack) / Conf.6 pz.(assortiti)			
15-40	DR.3061.00	DR.3062.00	DR.3063.00
45-80	DR.3061.01	DR.3062.01	DR.3063.01



Stainless steel K-files
Lime in acciaio inox tipo K

Pack of 6 pcs. / Conf. 6 pz.

ISO Color / No	21 mm	25 mm	28 mm
10	DR.3051.10	DR.3052.10	DR.3053.10
15	DR.3051.15	DR.3052.15	DR.3053.15
20	DR.3051.20	DR.3052.20	DR.3053.20
25	DR.3051.25	DR.3052.25	DR.3053.25
30	DR.3051.30	DR.3052.30	DR.3053.30
35	DR.3051.35	DR.3052.35	DR.3053.35
40	DR.3051.40	DR.3052.40	DR.3053.40
45	DR.3051.45	DR.3052.45	DR.3053.45
50	DR.3051.50	DR.3052.50	DR.3053.50
55	DR.3051.55	DR.3052.55	DR.3053.55
60	DR.3051.60	DR.3052.60	DR.3053.60
70	DR.3051.70	DR.3052.70	DR.3053.70
80	DR.3051.80	DR.3052.80	DR.3053.80
Assorted (6 pcs/pack) / Conf.6 pz.(assortiti)			
15-40	DR.3051.00	DR.3052.00	DR.3053.00
45-80	DR.3051.01	DR.3052.01	DR.3053.01

Endodontic Instruments / Strumenti Canalari



NiTi reamers NiTi reamers

ISO
Color / No 21 mm 25 mm 28 mm

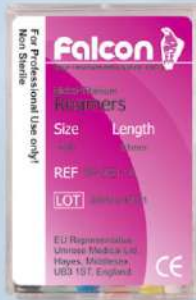

ISO Color / No	21 mm	25 mm	28 mm
10	DR.3021.10	DR.3022.10	DR.3023.10
15	DR.3021.15	DR.3022.15	DR.3023.15
20	DR.3021.20	DR.3022.20	DR.3023.20
25	DR.3021.25	DR.3022.25	DR.3023.25
30	DR.3021.30	DR.3022.30	DR.3023.30
35	DR.3021.35	DR.3022.35	DR.3023.35
40	DR.3021.40	DR.3022.40	DR.3023.40
45	DR.3021.45	DR.3022.45	DR.3023.45
Assorted (6 pcs/pack) / Conf.6 pz.(assortiti)			
15-40	DR.3021.00	DR.3022.00	DR.3023.00

Pack of 6 pcs. / Conf. 6 pz.

NiTi finger spreaders NiTi spreaders

ISO
Color / No 21 mm 25 mm 28 mm



ISO Color / No	21 mm	25 mm	28 mm
15	DR.3041.15	DR.3042.15	DR.3043.15
20	DR.3041.20	DR.3042.20	DR.3043.20
25	DR.3041.25	DR.3042.25	DR.3043.25
30	DR.3041.30	DR.3042.30	DR.3043.30
35	DR.3041.35	DR.3042.35	DR.3043.35
40	DR.3041.40	DR.3042.40	DR.3043.40
45	DR.3041.45	DR.3042.45	DR.3043.45
Assorted (6 pcs/pack) / Conf.6 pz.(assortiti)			
15-40	DR.3041.00	DR.3042.00	DR.3043.00

Pack of 6 pcs. / Conf. 6 pz.

Stainless steel reamers Reamers in acciaio inox

ISO
Color / No 21 mm 25 mm 28 mm



ISO Color / No	21 mm	25 mm	28 mm
10	DR.3071.10	DR.3072.10	DR.3073.10
15	DR.3071.15	DR.3072.15	DR.3073.15
20	DR.3071.20	DR.3072.20	DR.3073.20
25	DR.3071.25	DR.3072.25	DR.3073.25
30	DR.3071.30	DR.3072.30	DR.3073.30
35	DR.3071.35	DR.3072.35	DR.3073.35
40	DR.3071.40	DR.3072.40	DR.3073.40
45	DR.3071.45	DR.3072.45	DR.3073.45
50	DR.3071.50	DR.3072.50	DR.3073.50
55	DR.3071.55	DR.3072.55	DR.3073.55
60	DR.3071.60	DR.3072.60	DR.3073.60
70	DR.3071.70	DR.3072.70	DR.3073.70
80	DR.3071.80	DR.3072.80	DR.3073.80
Assorted (6 pcs/pack) / Conf.6 pz.(assortiti)			
15-40	DR.3071.00	DR.3072.00	DR.3073.00
45-80	DR.3071.01	DR.3072.01	DR.3073.01

Pack of 6 pcs. / Conf. 6 pz.

NiTi finger pluggers NiTi pluggers

ISO
Color / No 21 mm 25 mm 28 mm



ISO Color / No	21 mm	25 mm	28 mm
15	DR.3031.15	DR.3032.15	DR.3033.15
20	DR.3031.20	DR.3032.20	DR.3033.20
25	DR.3031.25	DR.3032.25	DR.3033.25
30	DR.3031.30	DR.3032.30	DR.3033.30
35	DR.3031.35	DR.3032.35	DR.3033.35
40	DR.3031.40	DR.3032.40	DR.3033.40
45	DR.3031.45	DR.3032.45	DR.3033.45
Assorted (6 pcs/pack) / Conf.6 pz.(assortiti)			
15-40	DR.3031.00	DR.3032.00	DR.3033.00

Pack of 6 pcs. / Conf. 6 pz.

Endodontic tips / Punte per endodonzia



Type E / Tipo E
Type S / Tipo S



E1

DR.2990.01
DR.2991.01



E2

DR.2990.02
DR.2991.02



E3

DR.2990.03
DR.2991.03



Endo wrench / Chiave manuale
DR.2990.00



Endodontic explorers
Sonde per canali

SOFT LINE INSTRUMENTS
soft and sure grip



Fig. 1
DR.584.014
Cream / Crema



Fig. DG 16
DR.584.164
Stewart
Cream / Crema

Classic Round 6 mm solid handle
Manico pieno da 6mm



Fig. DG 16
DR.584.161

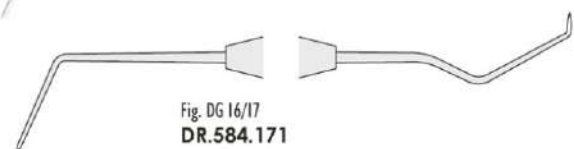

Fig. DG 16/17
DR.584.171

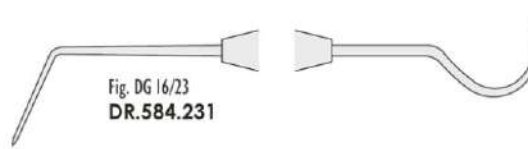

Fig. DG 16/23
DR.584.231

Endodontic excavators
Escavatori endodontici

Classic Round 6 mm solid handle
Manico pieno da 6mm



Fig. 32 L
DR.577.320

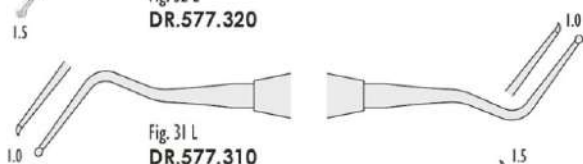

Fig. 31 L
DR.577.310

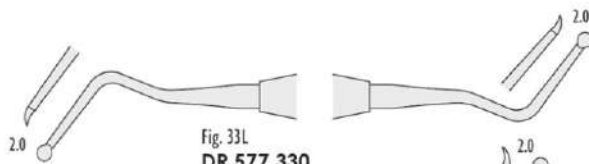

Fig. 33L
DR.577.330

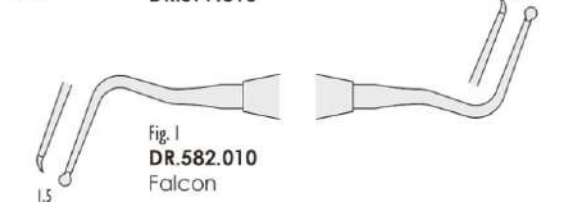

Fig. 1
DR.582.010
Falcon

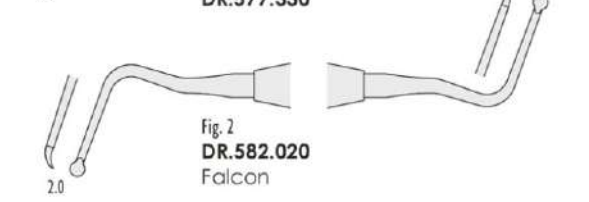

Fig. 2
DR.582.020
Falcon



SOFT LINE INSTRUMENTS
soft and sure grip



Fig. 1
DR.582.014
Falcon
Blue-Orange / Blu-Arancione



Fig. 2
DR.582.024
Falcon
Blue-Orange / Blu-Arancione



Hand pluggers / Otturatori per canali

Classic Round 6 mm solid handle
Manico pieno da 6mm



Fig. 1
DR.594.013
Falcon

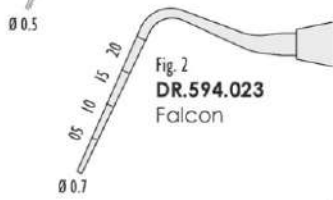

Fig. 2
DR.594.023
Falcon



Fig. 3
DR.594.033
Falcon



Fig. 4
DR.594.043
Falcon

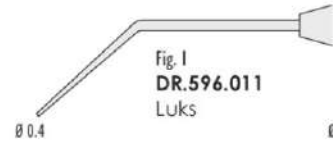

Fig. 1
DR.596.011
Luks



Fig. 2
DR.596.021
Luks



Fig. 3
DR.596.031
Luks

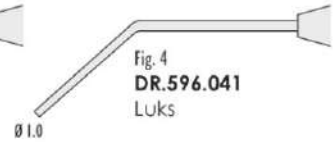

Fig. 4
DR.596.041
Luks

SOFT LINE INSTRUMENTS
soft and sure grip



Falcon



Fig. 1
DR.594.014
White / Bianco



Fig. 2
DR.594.024
Yellow / Giallo

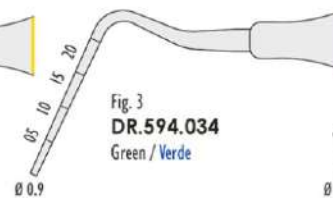

Fig. 3
DR.594.034
Green / Verde

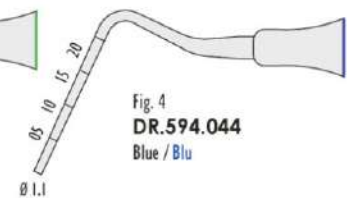

Fig. 4
DR.594.044
Blue / Blu



NiTi hand pluggers / Otturatori per canali NiTi

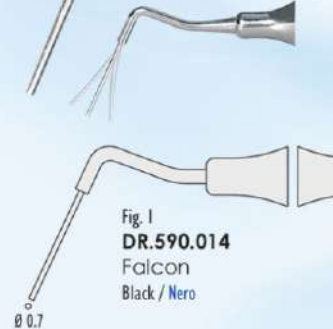

Fig. 1
DR.590.014
Falcon
Black / Nero

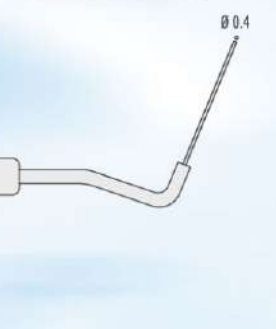
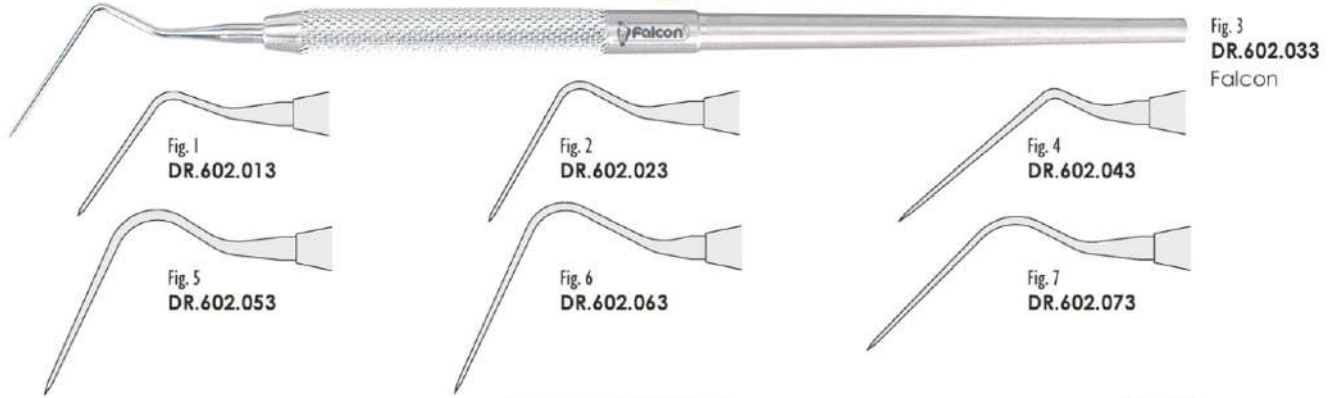

Fig. 2
DP.590.024
Falcon
Black / Nero

Endodontics

Hand spreaders
Spreader per endodonzia

Classic-Round 6 mm solid handle
Manico pieno da 6mm



SOFT LINE INSTRUMENTS
soft and sure grip

135°C
Autoclavabile
Autoclavabile

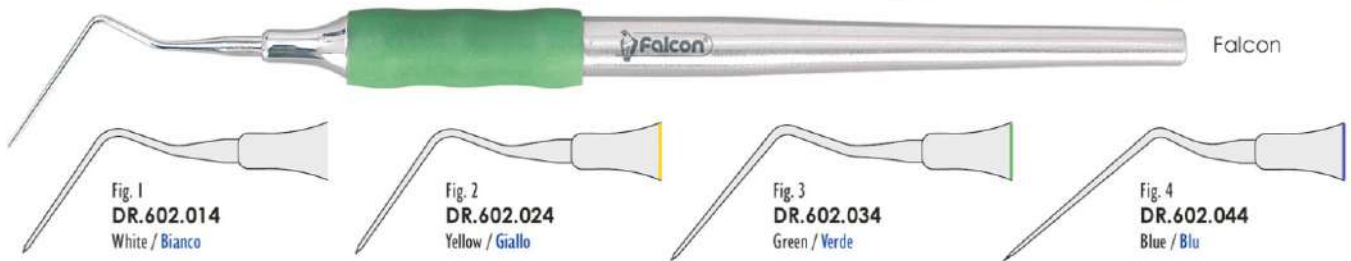

Micro endodontic pluggers/burnishers
Micro otturatori/brunitori per endodonzia

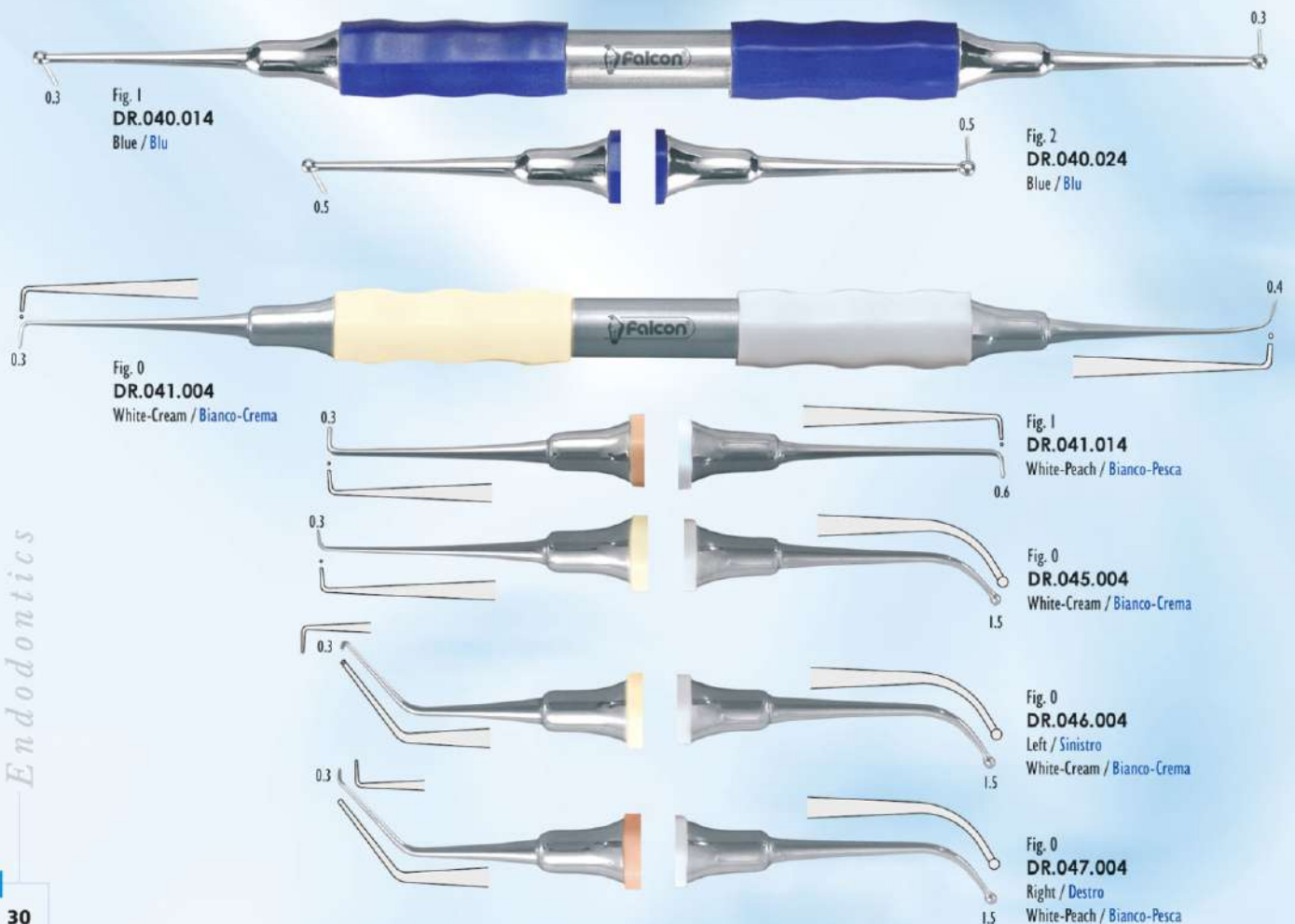



Perforation repair instruments / Strumenti per cure canalari

SOFT LINE INSTRUMENTS
soft and sure grip

135°C
Autoclavabile
Autoclavabile



Fig. 1
DR.865.014
Gray-White / Grigio-Bianco



Fig. 1
DR.866.014
Gray-White / Grigio-Bianco



Fig. 2
DR.866.024
White-Light Blue / Bianco-Celeste



Fig. 1
DR.879.014
Gray-White / Grigio-Bianco



Fig. 2
DR.879.024
White-Light Blue / Bianco-Celeste



Endodontic retractors / Divaricatori per endodonzia



Fig. 1
DS.488.014
Blue / Blu



Fig. 2
DS.488.024
Red / Rosso

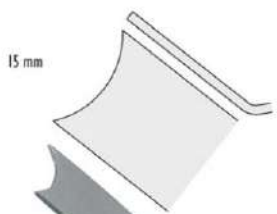

Fig. 3
DS.488.034
Green / Verde

Endodontic curettes / Curette per endodonzia



Fig. 2/4
DS.126.044
Molt
Red-Pink / Rosso-Rosa



Fig. 1
DS.146.014
Ruddle
Left / Sinistro
Red-Peach / Rosso-Pesca



Fig. 2
DS.146.024
Ruddle
Right / Destro
Red-Orange / Rosso-Arancione



Fig. 1
DS.147.014
Ruddle
Left / Sinistro
Red-Peach / Rosso-Pesca



Fig. 2
DS.147.024
Ruddle
Right / Destro
Red-Orange / Rosso-Arancione

Endodontic forceps / Pinze per endodonzia

Micro forceps for removing broken files
Micro pinze per asportare frammenti di lime



DR.587.030
Straight / Dritto

DR.587.040
Upward / Piegato in alto

DR.587.050
Left / Piegato a sinistra

DR.587.060
Right / Piegato a destra

Silver points and broken files removing forceps
Pinze per la rimozione di corpi (lime rotte, punti in argento)



DR.587.130
125 mm

Endodontic tweezers / Endo pinzetta



DR.586.020
150 mm

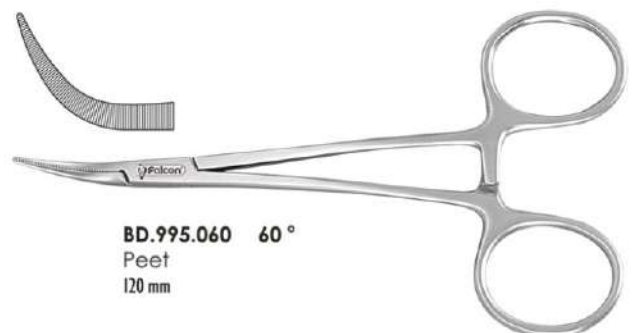

BD.995.060 60°
Peet
120 mm

Restorative / Conservativa



Compo-Fill Instruments

Easy
COLOR

Ultra Light weight
Non-stick tips
TIN coated

Ultraleggeri
Punte antiaderenti
Rivestimento in nitruro di titanio



Silicone handle with Aluminum core
Manico in silicone con anima in alluminio



Pluggers / Otturatori



Fig. 5A DR.051.051



Fig. 3 DR.073.031 Hollenback



Fig. 1 DR.091.011 Super



Fig. 0T DR.092.001 Tanner



Fig. 0/1 DR.063.011 Black



Fig. 1/2 DR.063.021 Black

Burnishers / Brunitori

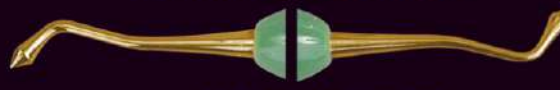

Fig. 21B DR.111.211 Acorn/ Wescott



Fig. 1 DR.121.011 Contact Former



Fig. 2 DR.121.021 Contact Former



Fig. 2 DR.139.021 Ladmore



Fig. 3 DR.139.031 Ladmore



Fig. 27/29 DR.148.041 White



Fig. 1 DR.100.011



Fig. 1L DR.101.011



Fig. 155 DR.135.551



Filling Instruments / Strumenti Per Otturazioni

Easy
COLOR



Autoclavable
Autoclavabile

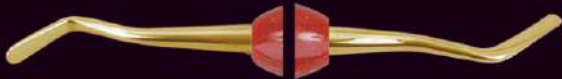

Fig. 156(A8) DR.426.561



Fig. 8A DR.431.081



Fig. 1 DR.445.011 Boghosian



Fig. 2 DR.445.021 Boghosian



Fig. 1 DR.451.011 Falcon



Fig. 2 DR.451.021 Falcon



Fig. 1 DR.457.011 Goldstein



Fig. 2 DR.457.021 Goldstein



Fig. 3 DR.457.031 Goldstein



Fig. 4 DR.457.041 Goldstein



Fig. 1 DR.458.011 Goldstein-Mini



Fig. 3 DR.458.031 Goldstein-Mini



Fig. 4 DR.458.041 Goldstein-Mini



Fig. 1 DR.459.011 Goldstein-Micro

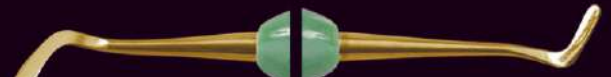

Fig. 4/5 DR.460.051 Gregg



Fig. 0 DR.463.001 Heidemann



Fig. 1 DR.463.011 Heidemann



Fig. 2 DR.463.021 Heidemann



Fig. W3 DR.513.031



Fig. 1 DR.425.011



Fig. 6 DR.425.061



Fig. 178 DR.426.781



Fig. 49 DR.440.491



Fig. 179 DR.440.791

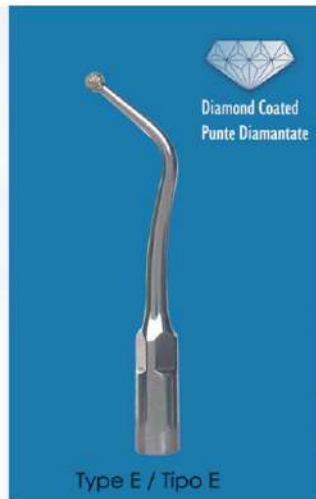

Cavity preparation tips / Punte per la preparazione delle cavità



Amalgam carriers / Spingi amalgama

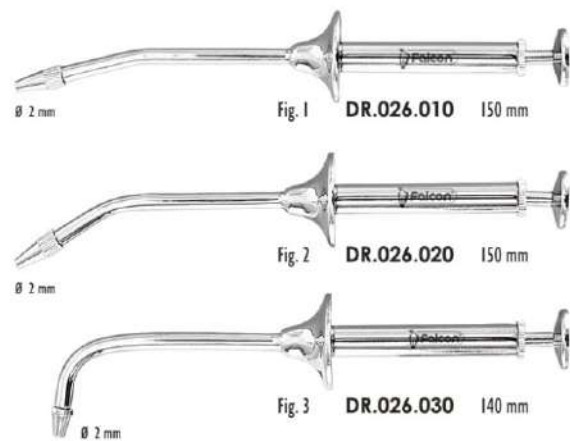
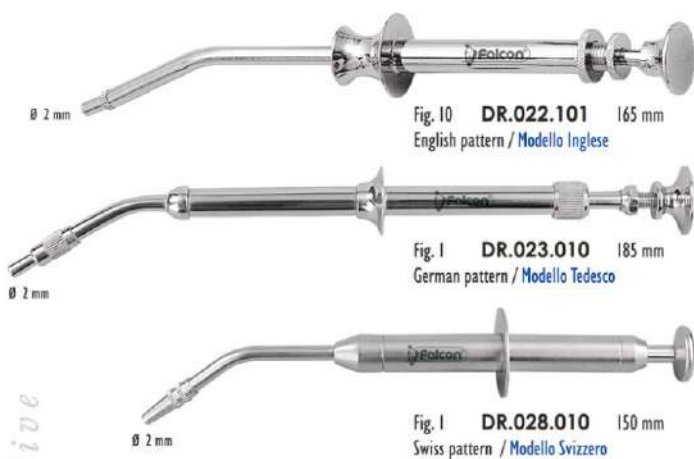
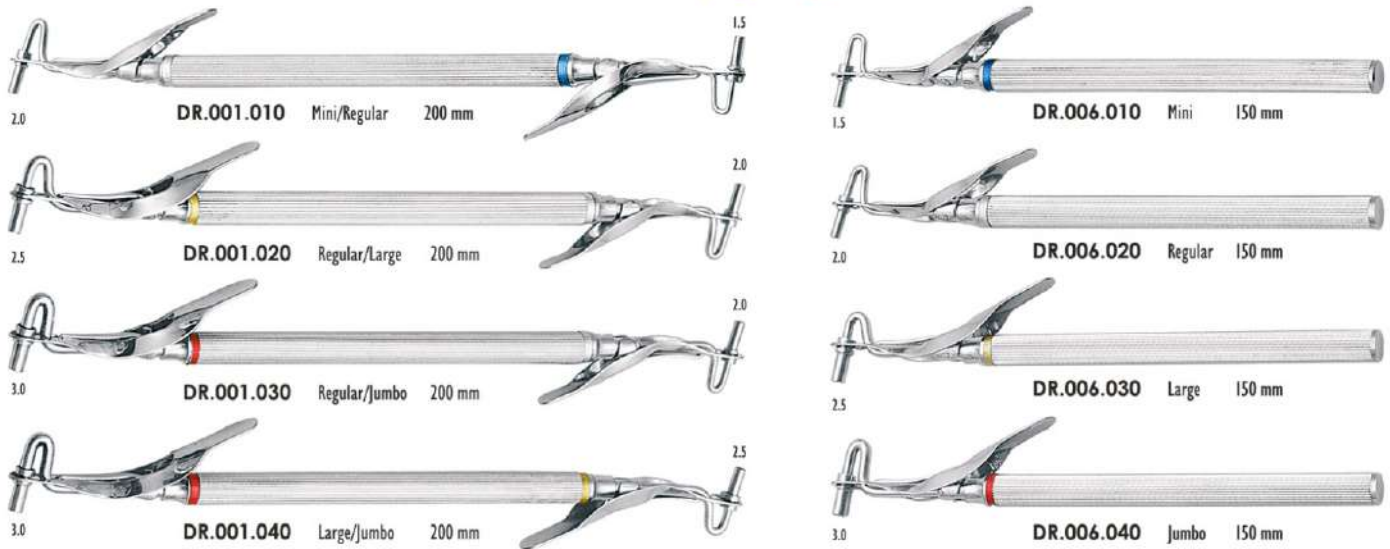

For micro filling / Per micro otturazioni

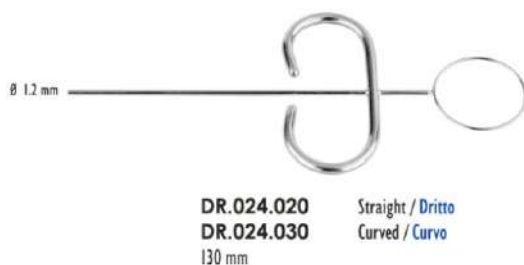

Amalgam well / Mortaio per amalgama





Classic Round
6 mm solid handle
Manico pieno da 6mm

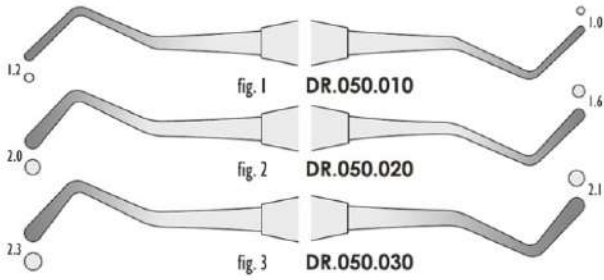

Falcon

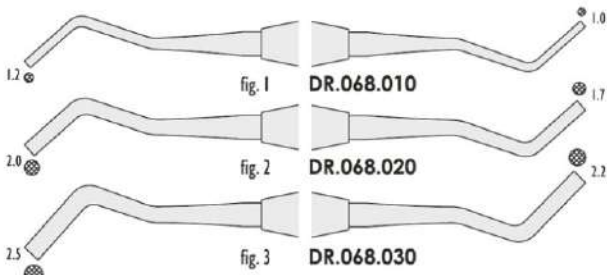

Falcon

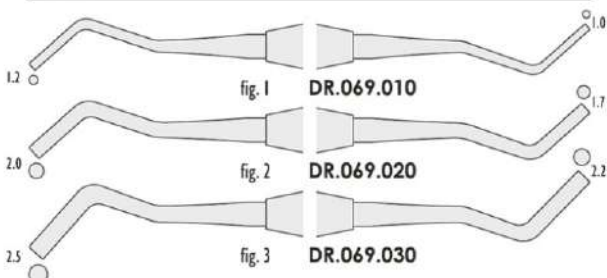

Wards

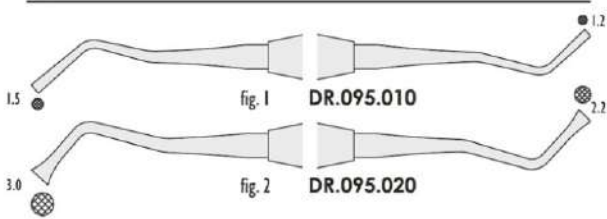

Markley

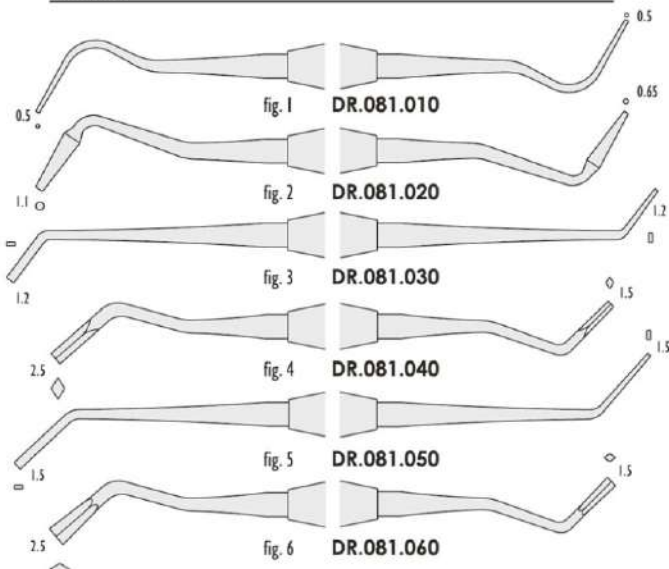

Standard

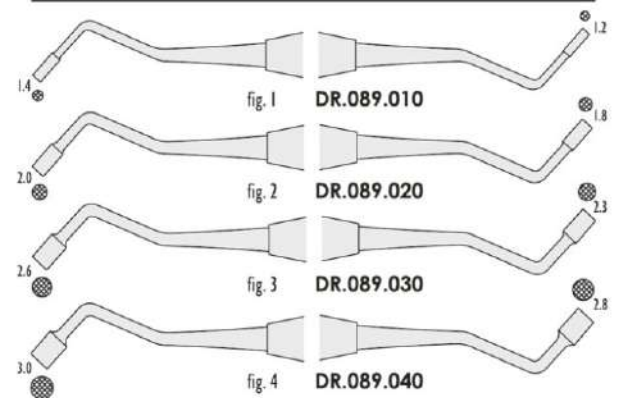

Standard

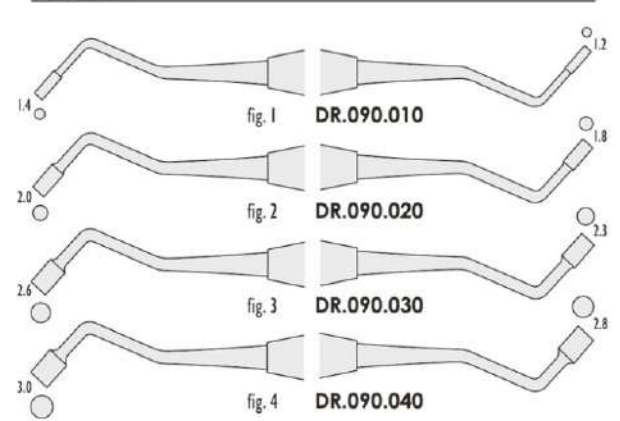

Mall

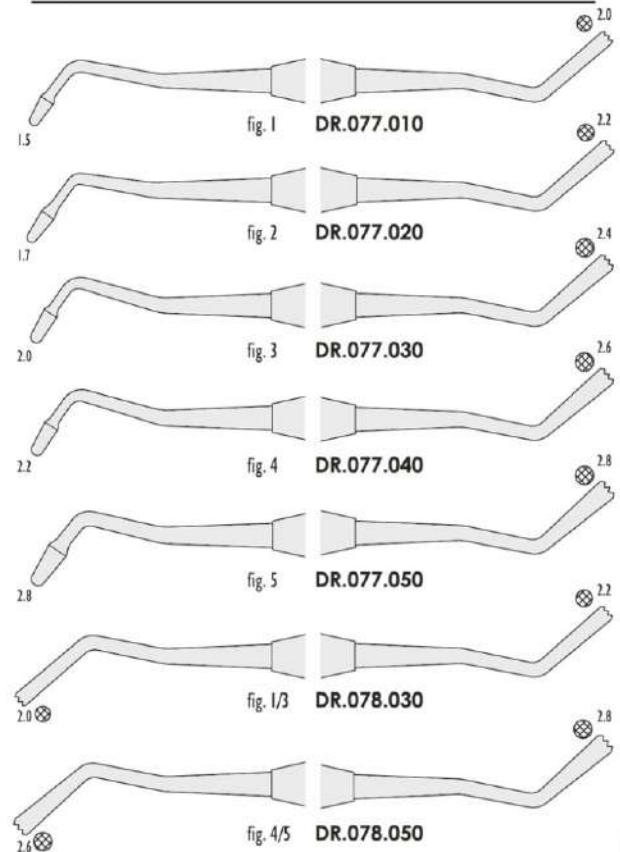

SOFT LINE INSTRUMENTS
 soft and sure grip

135° C
 Autoclavable
 Autoclavabile



Fig. 1 DR.091.014 Super Plugger Blue - Yellow / Blu - Giallo

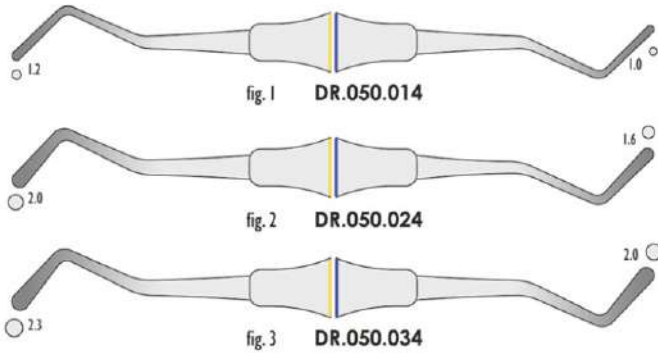

Falcon

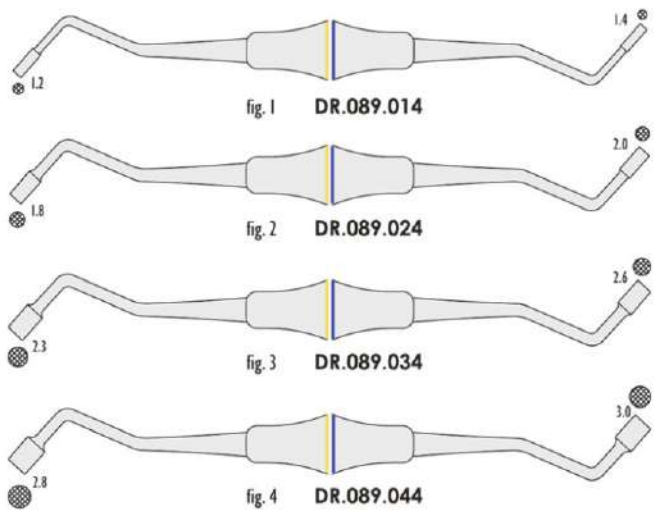

Markley

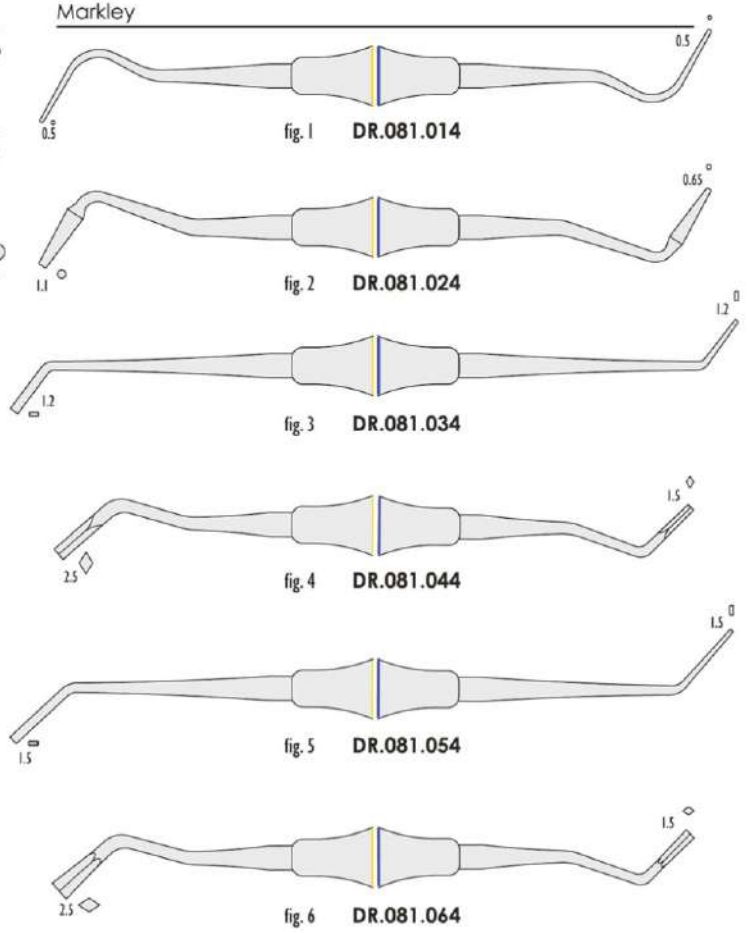

Classic-8
 5.5 mm solid handle
 Manico pieno da 5.5 mm



Falcon Polska

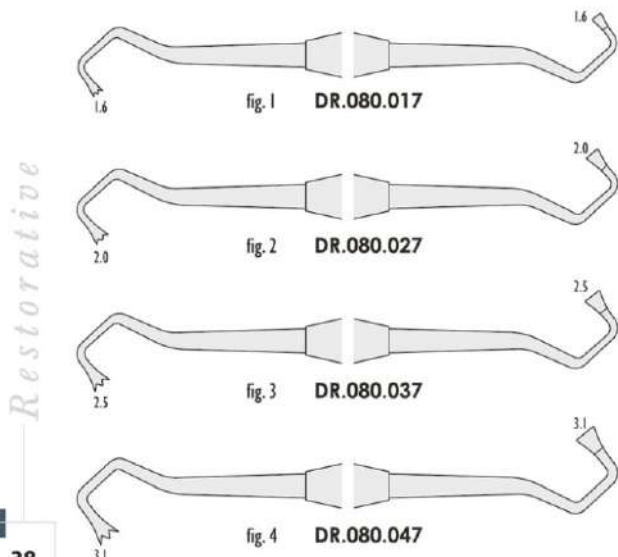

Black

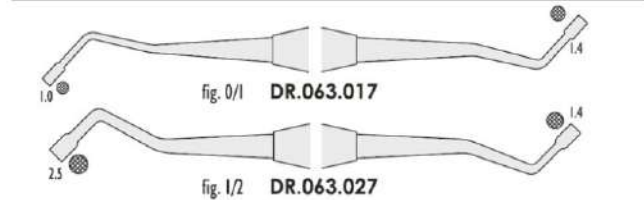

Falcon Polska

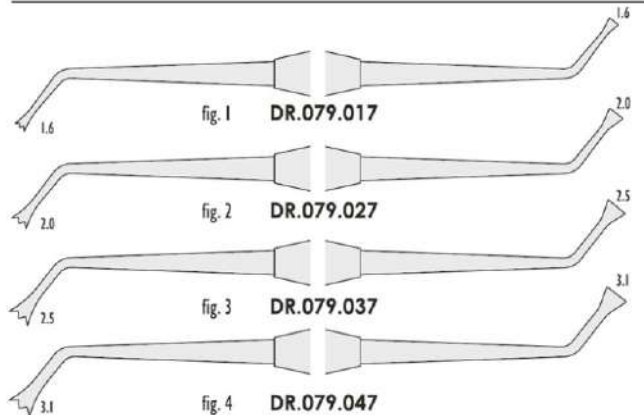

Restorative



Classic Round
6 mm solid handle
Manico pieno da 6mm

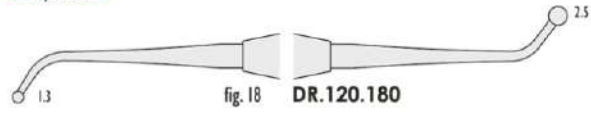

Acorn / Wescott

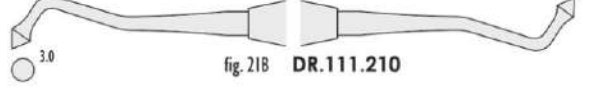
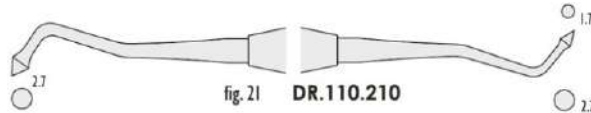

Ladmore

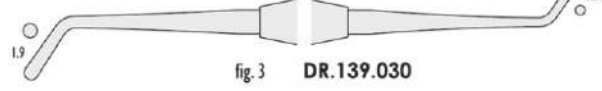
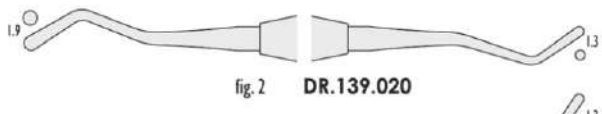

Beavertail / White

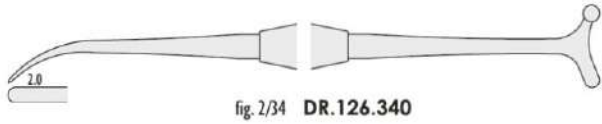
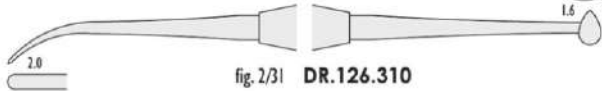
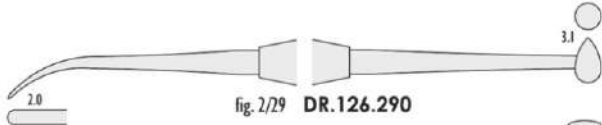

Falcon

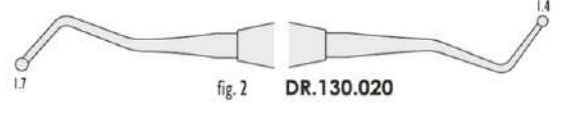
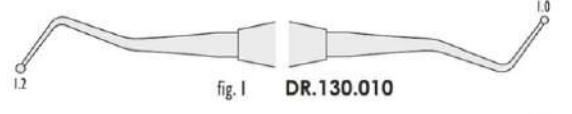

White

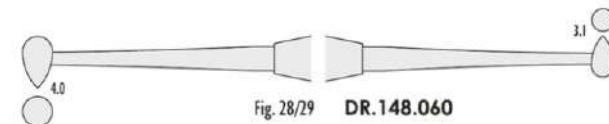
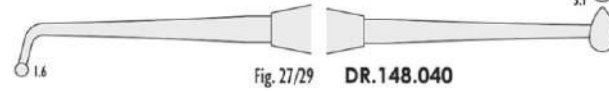
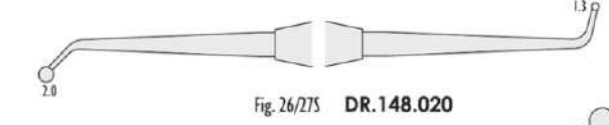

CLASSIC-LITE
8 mm hollow handle
Manico vuoto da 8 mm



Acorn / Wescott



White



Falcon

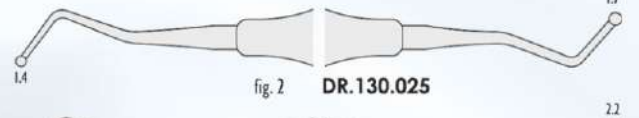

SOFT LINE INSTRUMENTS
soft and sure grip



Acom/Wescott

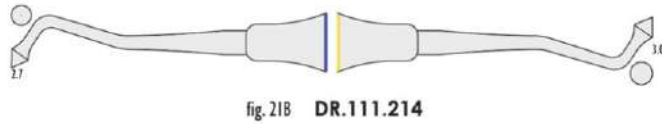
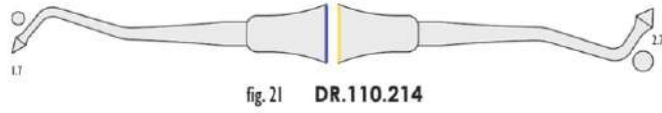

White

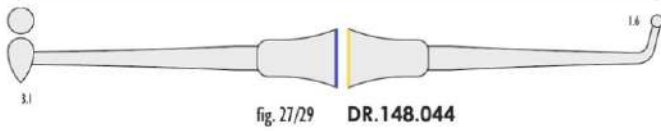

Freedman

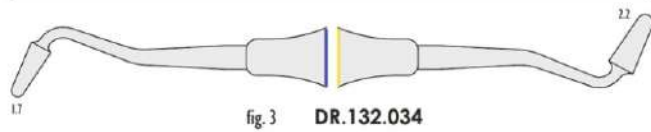

Falcon

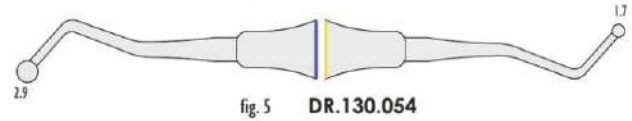
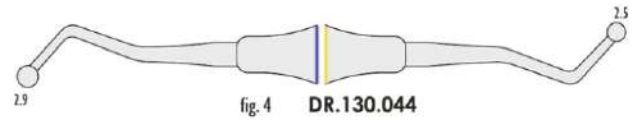
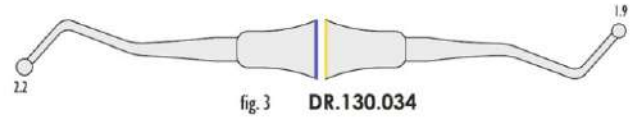
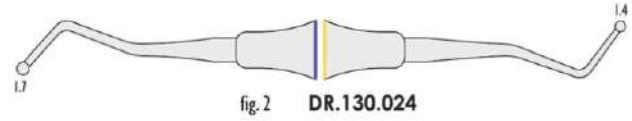
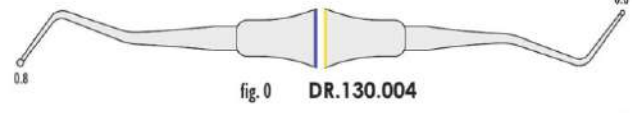

Classic-8 5.5 mm solid handle
Manico pieno da 5.5 mm



Falcon Polska

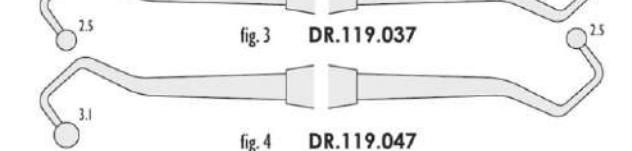
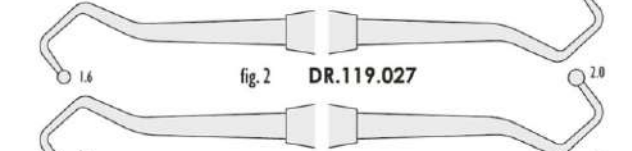
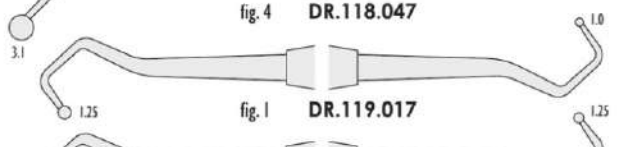
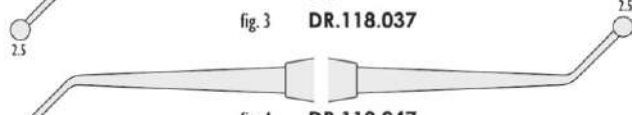
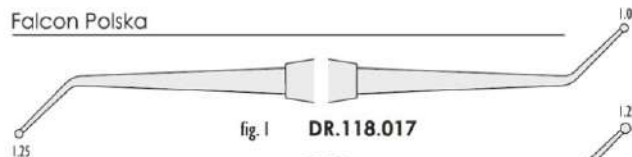
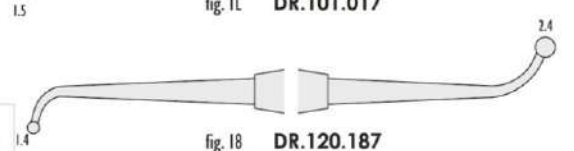
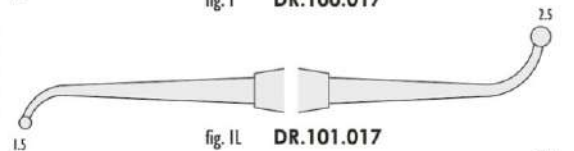
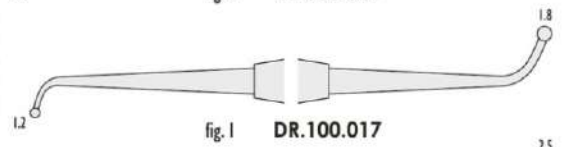
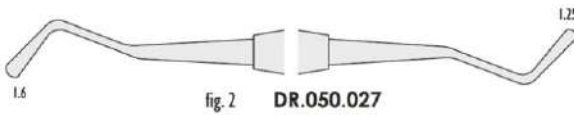
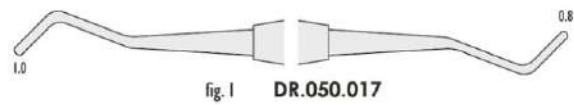

Restorative



Classic Round 6 mm solid handle
 Manico pieno da 6mm



Falcon

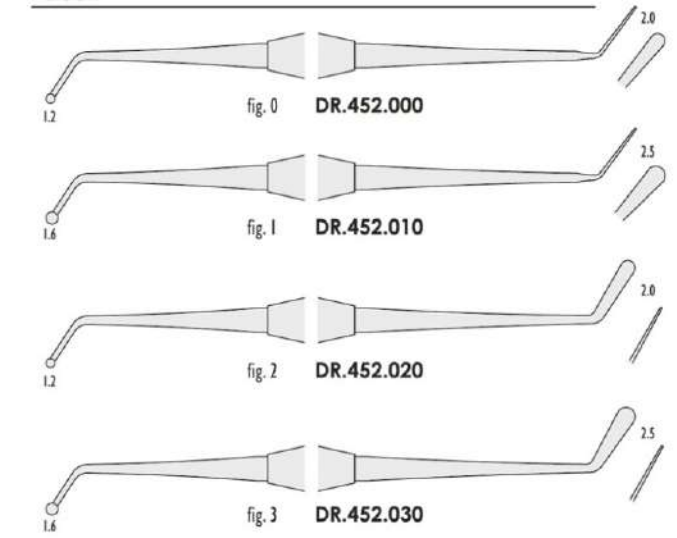
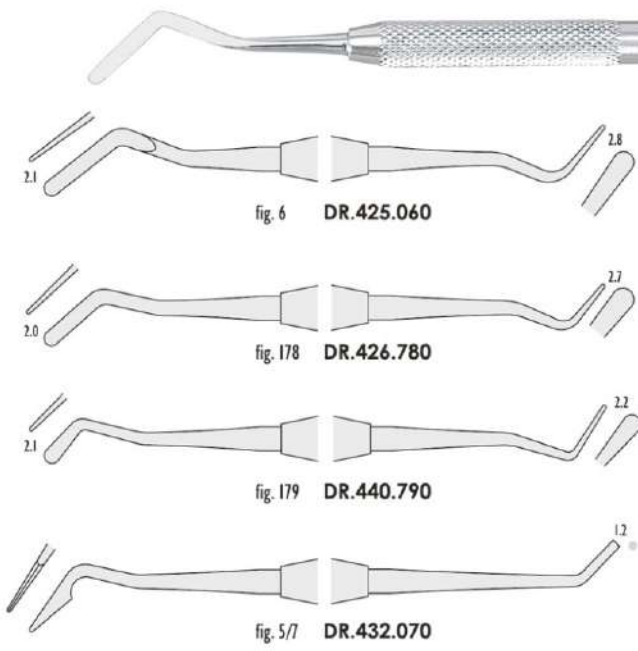

Gregg

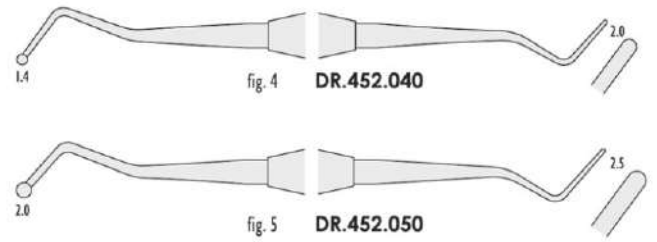
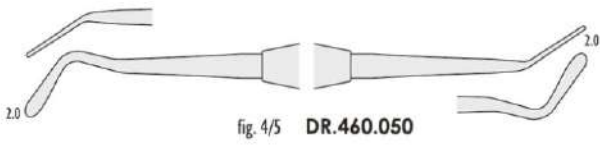

Woodson

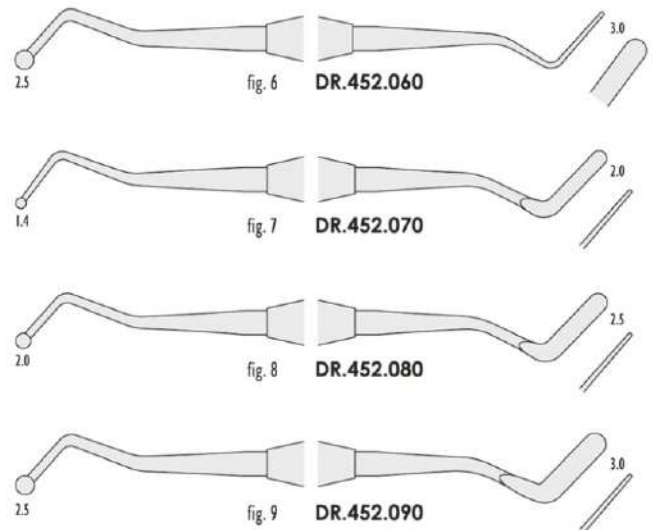
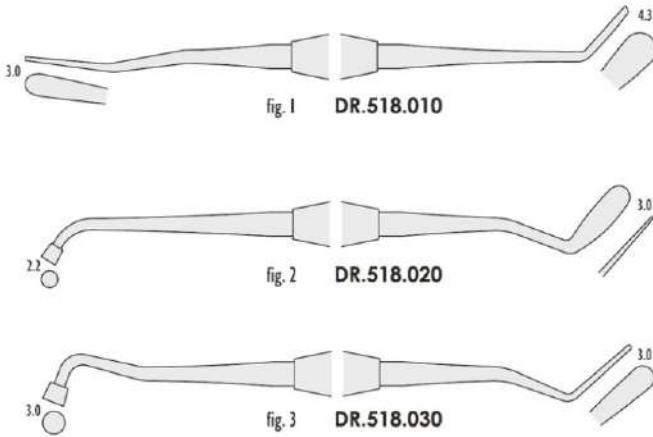

Heidemann

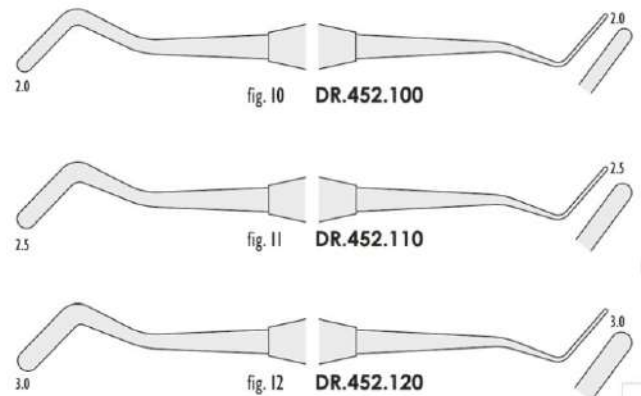
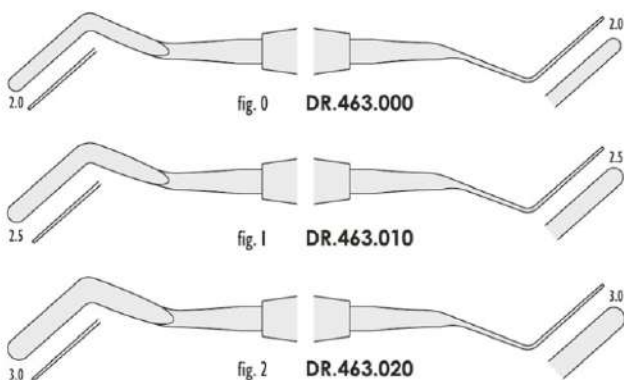

Restorative

Composite/Plastic Filling Instruments
Strumenti Per Otturazioni Plastiche

CLASSIC-LITE

8 mm hollow handle
 Manico vuoto da 8 mm



Falcon

Falcon

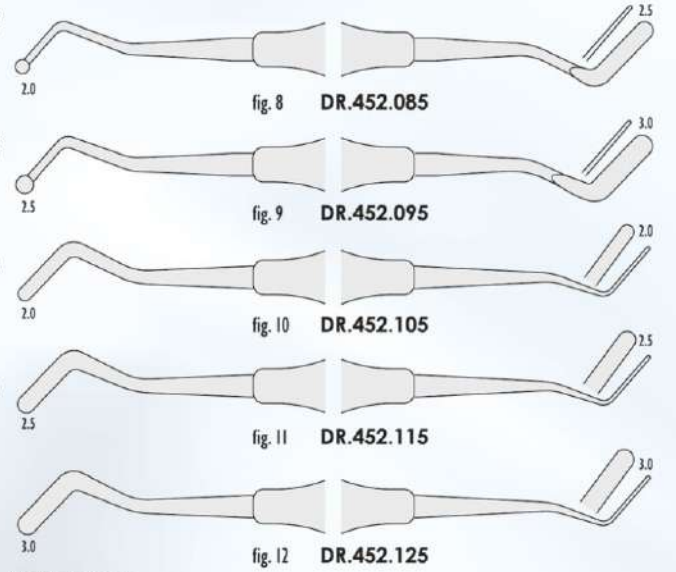
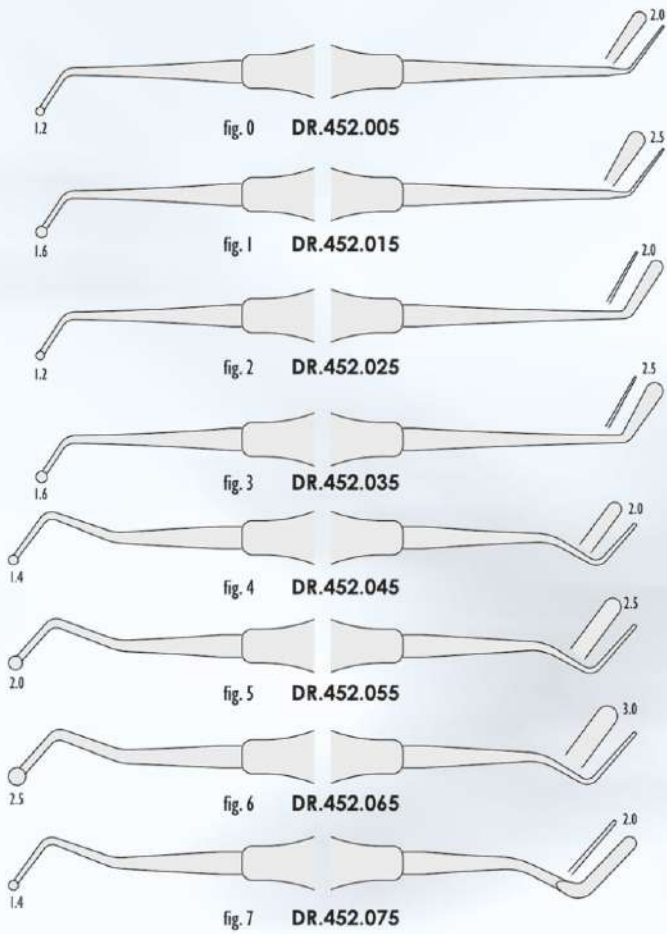

Heidemann

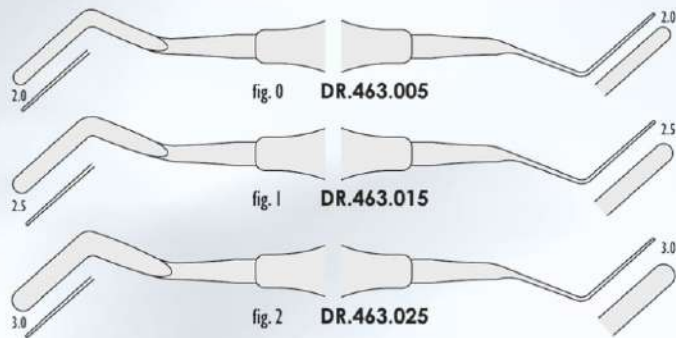

Classic-8

5.5 mm solid handle
 Manico pieno da 5.5 mm



Heidemann

Restorative

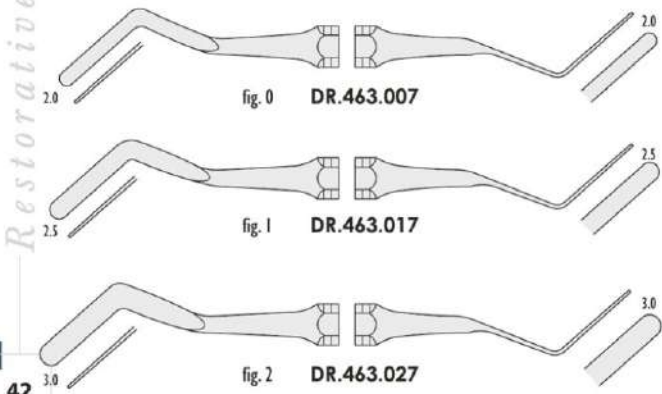
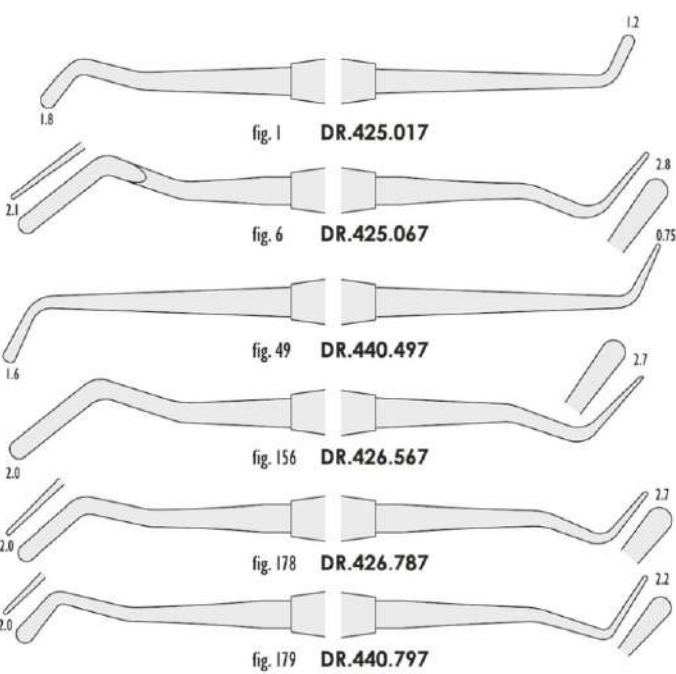



SOFT LINE INSTRUMENTS
 soft and sure grip



Blue - White / Blu - Bianco

Falcon

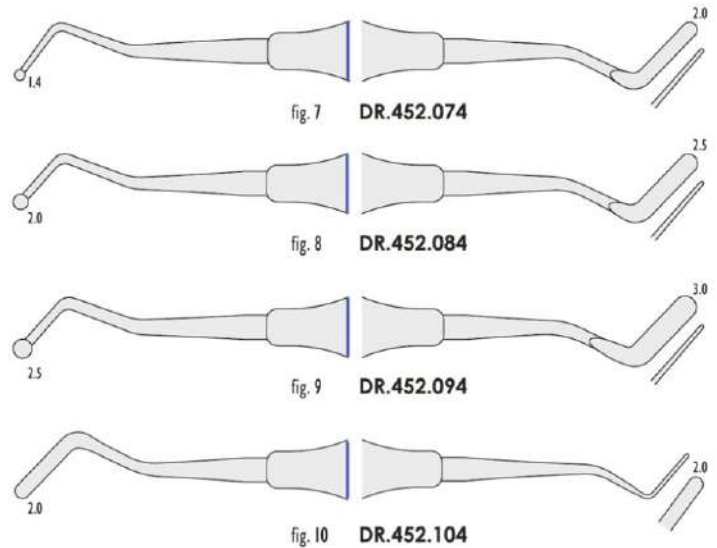
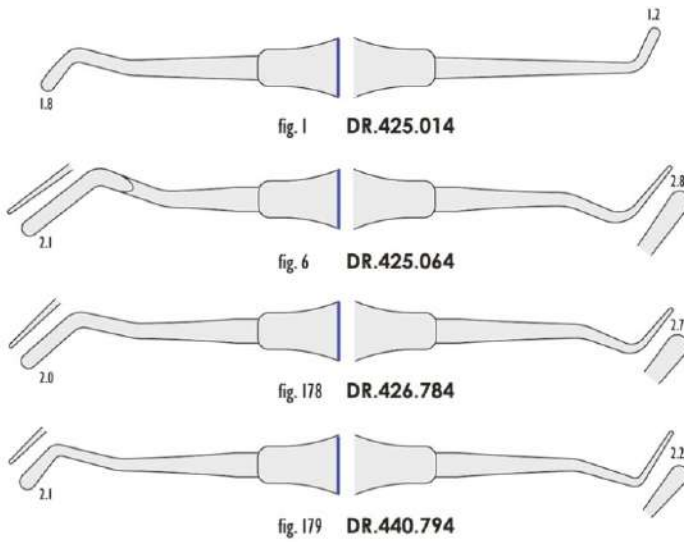

Heidemann

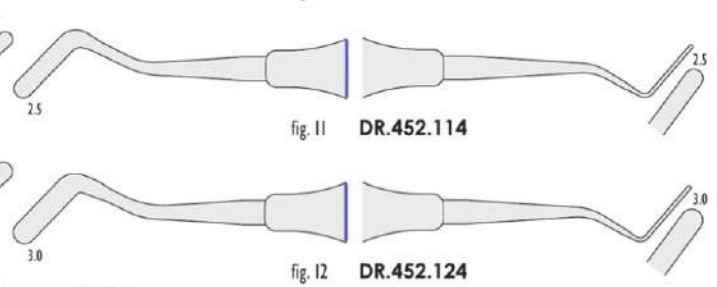
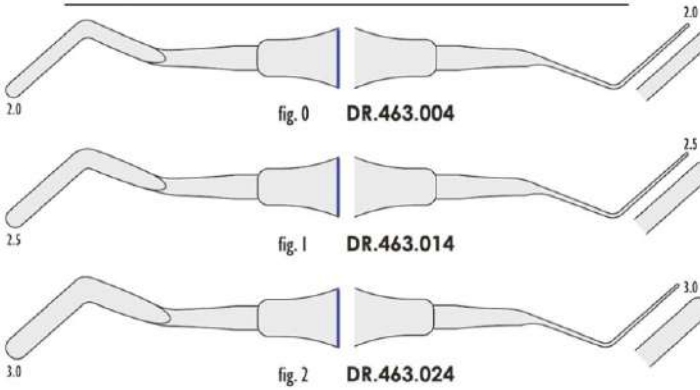

Gregg

Applicators for calcium hydroxide / Applicatori per softofondo



Applicator for medicaments / Applicatore per medicamenti





Fig. 1 DR.960.014



Fig. 2 DR.960.024



Fig. 3 DR.960.034



Fig. 1 DR.960.011



Fig. 2 DR.960.021



Fig. 3 DR.960.031



Fig. 00 DR.959.008



Fig. 0 DR.960.008



Fig. 1 DR.960.018



Fig. 2 DR.960.028



Fig. 3 DR.960.038



Fig. 4 DR.960.048



Weston DR.974.038



DR.980.027



DR.996.005

Glass mixing slabs / Piastre di miscelazione In vetro



- DR.998.010 95 x 70 x 5 mm
- DR.998.020 120 x 80 x 5 mm
- DR.998.030 150 x 80 x 12 mm



Blue - Red / Blu - Rosso

SOFT LINE

INSTRUMENTS
soft and sure grip



Autoclavabile
Autoclavabile

Falcon

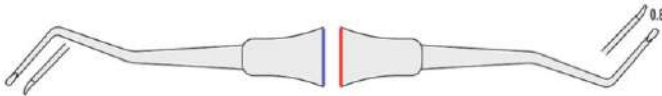

fig. 0 DR.623.004

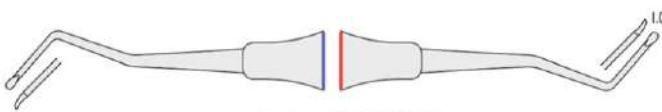

fig. 1 DR.623.014

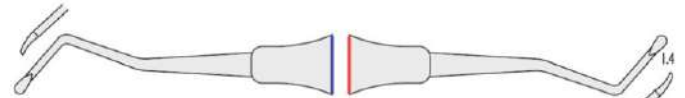

fig. 2 DR.623.024

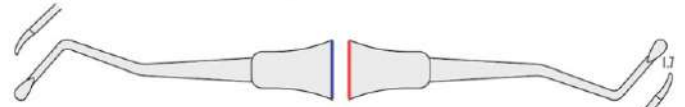

fig. 3 DR.623.034

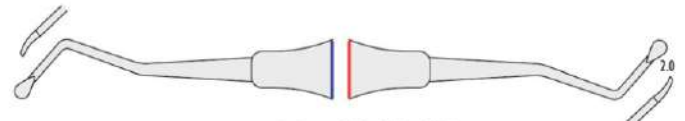

fig. 4 DR.623.044



Classic Round

6 mm solid handle
Manico pieno da 6mm

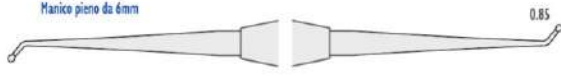

fig. 6 DR.609.060

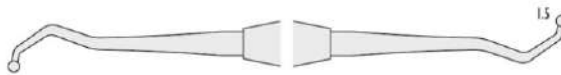

fig. 14 DR.609.140

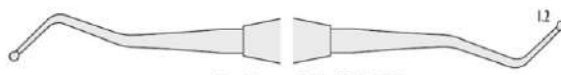

fig. 17 DR.609.170

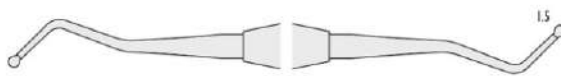

fig. 18 DR.609.180

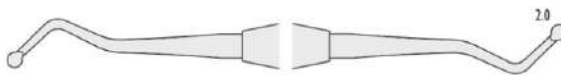

fig. 19 DR.609.190



fig. 17W DR.610.170

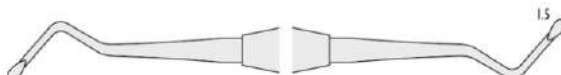

fig. 18W DR.610.180



fig. 19W DR.610.190

Falcon

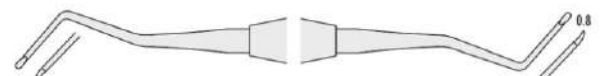

fig. 0 DR.623.000

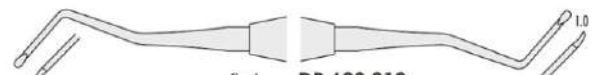

fig. 1 DR.623.010

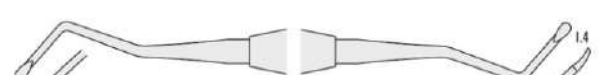

fig. 2 DR.623.020

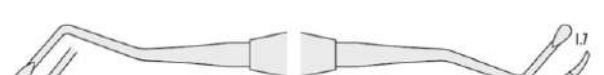

fig. 3 DR.623.030

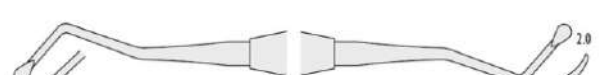

fig. 4 DR.623.040



Restorative

Classic-8

5.5 mm solid handle
Manico pieno da 5.5 mm



Falcon Polska

Type A



fig. 1 DR.649.017



fig. 2 DR.649.027



fig. 3 DR.649.037



fig. 4 DR.649.047

Type C



fig. 1 DR.650.017



fig. 2 DR.650.027

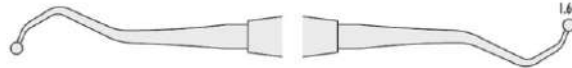

fig. 3 DR.650.037



fig. 4 DR.650.047

Classic-8

5.5 mm solid handle
Manico pieno da 5.5 mm



Falcon Polska

Type B

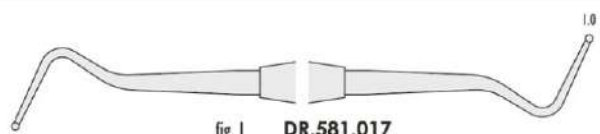

fig. 1 DR.581.017

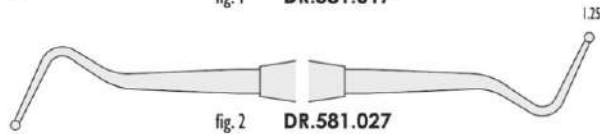

fig. 2 DR.581.027

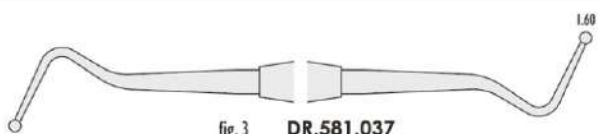

fig. 3 DR.581.037

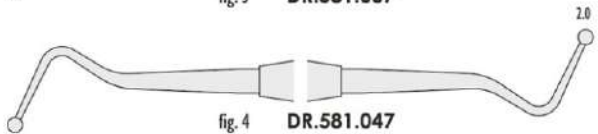

fig. 4 DR.581.047

Classic Round

6 mm solid handle
Manico pieno da 6 mm



Blacks

Ferrier

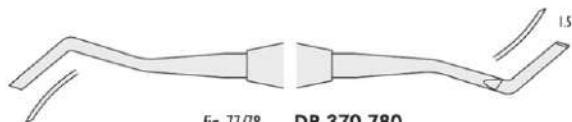

fig. 77/78 DR.370.780

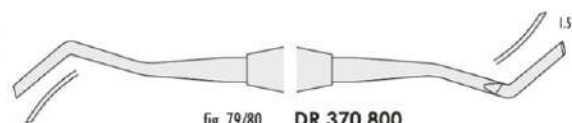

fig. 79/80 DR.370.800

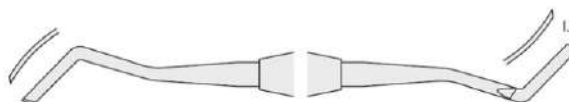

fig. 26 DR.370.260

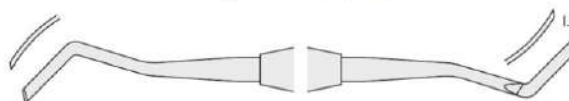

fig. 27 DR.370.270

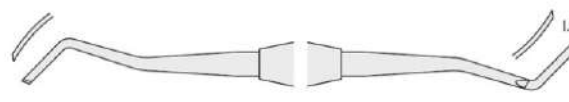

fig. 28 DR.370.280

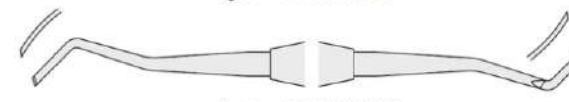

fig. 29 DR.370.290

Restorative



Carvers / Strumenti per modellare

Classic Round 6 mm solid handle
 Manico pieno da 6mm

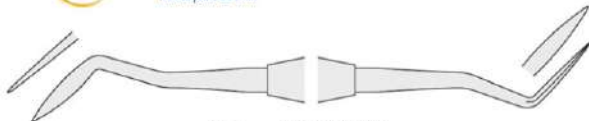

Fig. 3 **DR.230.030**
Hollenback

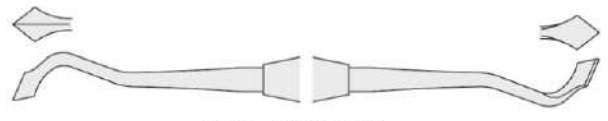

Fig. 2/3 **DR.225.030**
Frahm

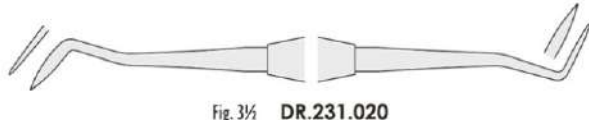

Fig. 3½ **DR.231.020**
Hollenback

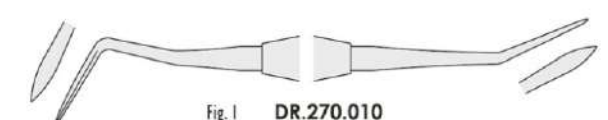

Fig. 1 **DR.270.010**
Wards

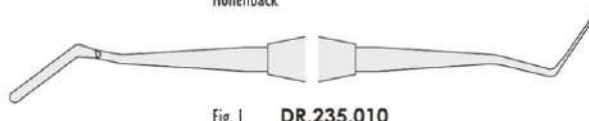

Fig. 1 **DR.235.010**
Interproximal

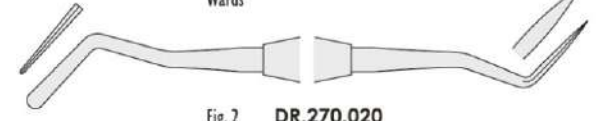

Fig. 2 **DR.270.020**
Wards

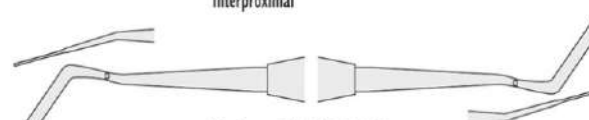

Fig. 2 **DR.235.020**
Interproximal

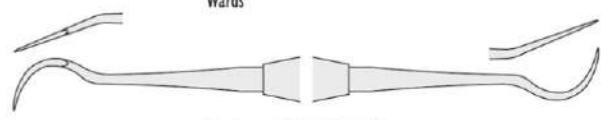

Fig. 8 **DR.274.080**
Wiland

SOFT LINE INSTRUMENTS
 soft and sure grip

Carvers / Strumenti per modellare



Fig. 3 **DR.230.034** Hollenback



Fig. 3½ **DR.231.024** Hollenback

Finishing knives / Strumenti per rifinire otturazioni



Fig. 2 **DR.297.024** USC



Fig. 25 **DR.298.024** USC



Fig. 28 **DR.300.284** Black



Fig. 29 **DR.300.294** Black

Finishing Knives and Cleoid-Discoid Strumenti Per Rfinire Otturazioni e Cleoidi-Discoidi

CLASSIC-LITE 8 mm hollow handle
Manico vuoto da 8 mm

Finishing knives / Strumenti per rifinire otturazioni



Fig. 6T DR.296.065 Tanner



Fig. 2 DR.297.025 USC



Fig. 2S DR.298.025 USC

CLASSIC ROUND 6 mm solid handle
Manico pieno da 6 mm

Cleoid-Discoid / Cleoidi-Discoidi

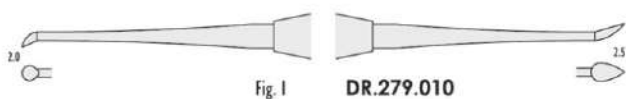

Fig. 1 DR.279.010

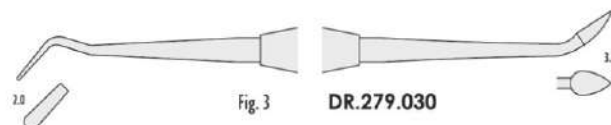

Fig. 3 DR.279.030

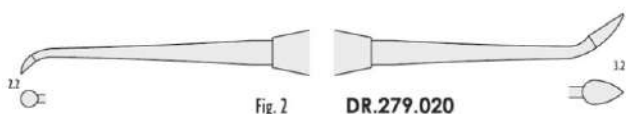

Fig. 2 DR.279.020

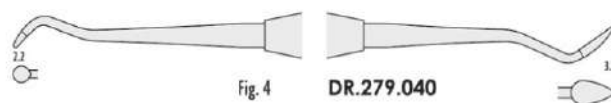

Fig. 4 DR.279.040

SOFT LINE INSTRUMENTS
soft and sure grip

Cleoid-Discoid / Cleoidi-Discoidi

135°C
Autoclavable
Autoclavabile

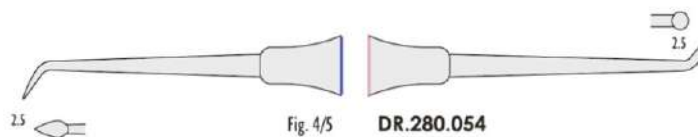

Fig. 4/5 DR.280.054

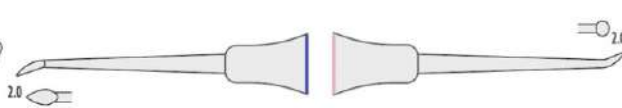

Fig. 89/92 DR.280.924

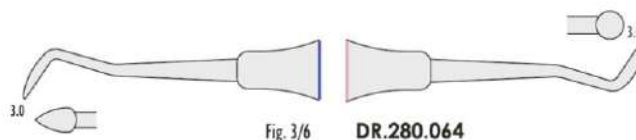

Fig. 3/6 DR.280.064

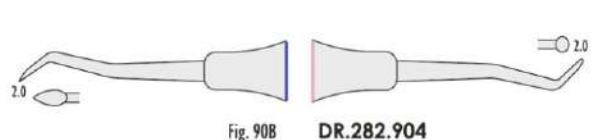

Fig. 90B DR.282.904

Filling removing instrument / Strumenti per rimuovere otturazioni



Fig. 1 DR.527.014



Falcon automatic crown and bridge remover
Leva ponti e corone automatico Falcon

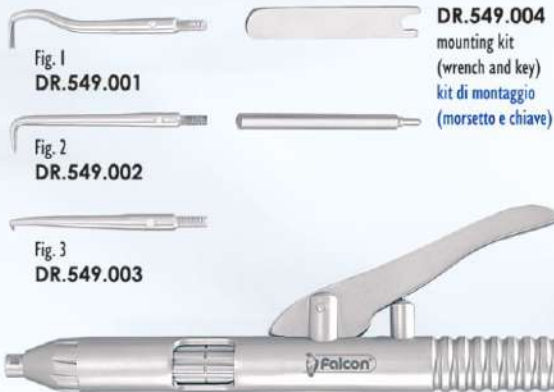

Fig. 1
DR.549.001



Fig. 2
DR.549.002

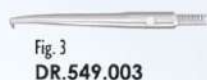

Fig. 3
DR.549.003

DR.549.000
Contents / Contiene:
1 Crown remover / Levacorone
3 Tips / Punta
1 Mounting kit (wrench and key)
kit di montaggio (morsetto e chiave)

DR.549.010
Set of 3 tips and mounting kit
Serie di 3 punte e kit di montaggio

Falcon automatic crown and bridge remover
Leva ponti e corone automatico Falcon

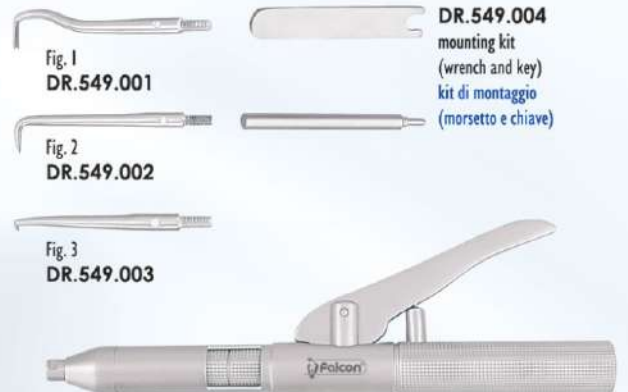

Fig. 1
DR.549.001

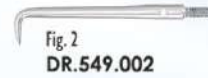

Fig. 2
DR.549.002



Fig. 3
DR.549.003

DR.550.000
Contents / Contiene:
1 Crown remover / Levacorone
3 Tips / Punta
1 Mounting kit (wrench and key)
Kit di montaggio (morsetto e chiave)

DR.549.010
Set of 3 tips and mounting kit
Serie di 3 punte e kit di montaggio

Falcon semi-automatic crown and bridge remover
Leva ponti e corone semiautomatico Falcon



Fig. 1
DR.552.001



Fig. 2
DR.552.002



Fig. 3
DR.552.003

DR.552.004
Tightening key / Chiave di serraggio

DR.552.000
Contents / Contiene:
1 crown remover / Levacorone
3 tips / Punta
1 tightening key / Chiave

DR.552.010
Set of 3 tips and tightening key
Serie di 3 punte e chiave

Morrel manual crown remover with spring
Levacorone manuale Morrel con molla

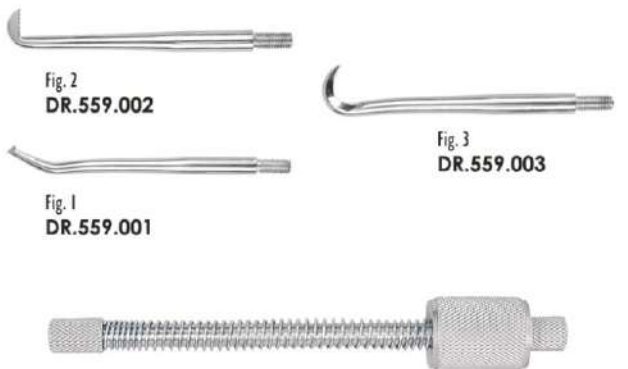

Fig. 2
DR.559.002



Fig. 1
DR.559.001



Fig. 3
DR.559.003

DR.560.000
Complete with 3 tips
Completo con 3 punte

DR.559.010
Set of 3 tips
Serie di 3 punte

Falcon manual crown remover double ended
Levacorone doppio manuale Falcon



Fig. 1
DR.554.001



Fig. 3
DR.554.003



Fig. 2
DR.554.002

DR.554.000
Complete with 3 tips
Completo con 3 punte

DR.554.010
Set of 3 tips
Serie di 3 punte

Morrel manual crown remover
Levacorone manuale Morrel



Fig. 2
DR.559.002



Fig. 1
DR.559.001



Fig. 3
DR.559.003

DR.559.000
Complete with 3 tips
Completo con 3 punte

DR.559.010
Set of 3 tips
Serie di 3 punte



Crown Instruments and Forceps for Articulating Paper
Strumenti per Corone e Pinzette per Carta da Articolazioni

Falcon manual crown remover double ended
Levacorone doppio manuale Falcon



Falcon manual crown remover single ended
Levacorone singolo manuale Falcon



Crown pliers / Pinze per corone



Crown spreaders / Apricorone



Forceps for articulating paper / Pinzette per carta da articolazioni





Matrix bands / Matrici

Super flexible 0.04 mm
Super flessibile 0.04 mm



DR.799.050 5 mm x 10 m
DR.799.060 6 mm x 10 m
DR.799.070 7 mm x 10 m

Flexible 0.05 mm
Flessibile 0.05 mm



DR.800.050 5 mm x 10 m
DR.800.060 6 mm x 10 m
DR.800.070 7 mm x 10 m

Tofflemire (pack of 12 / conf.12 pz.)



Fig. 101 **DR.810.101**



Fig. 102 **DR.810.102**

Ivory (pack of 12 / conf.12 pz.)



Fig. 11 **DR.806.010**
for children/per bambini



Fig. 12 **DR.806.020**
for children/per bambini



Fig. 14 **DR.805.010**



Fig. 15 **DR.805.020**



Fig. 16 **DR.805.030**

Nyström (pack of 12 / conf.12 pz.)



Fig. 2 **DR.808.020**



Fig. 4 **DR.808.040**



Fig. 5 **DR.808.050**



Fig. 6 **DR.808.060**



Fig. 7 **DR.808.070**

Matrix retainers / Porta matrici



DR.829.050
Falcon 5mm
with cheek protector/ con protezione guancia



Fig. 8
DR.830.085
Ivory 5 mm



Fig. 8
DR.830.086
Ivory 6 mm



Fig. 8
DR.830.087
Ivory 7 mm



DR.840.010
Tofflemire junior



DR.840.020
Tofflemire senior



DR.840.030
Tofflemire universal



DR.832.010
Nyström Left/ Sinistro



DR.832.020
Nyström Right/ Destro



Fig. 12A
DR.830.121
Ivory



Fig. 12
DR.830.120
Ivory



DR.855.010
Strip clamp straight
Morsetto per matrici dritto

Matrix pliers / Pinza per matrici



Falcon
DR.820.170
170 mm

Latex rubber dam / Diga in lattice



150mm x 150mm
Green / Verde
Mint flavour / Aromatizzata alla menta
Pack of 36 / Conf. 36 pz

- DR.899.010 Thin / Fine
- DR.899.020 Medium / Media
- DR.899.030 Heavy / Heavy

Rubber dam clamps / Uncini per diga

TRUE FLEX

Winged / Con alette
Premolars / Premolari

Fig. 00 DR.907.000 Fig. 0 DR.907.001 Fig. 2 DR.907.020 Fig. 2A DR.907.021

Winged / Con alette
Molars / Molari

Fig. 7 DR.907.070 Fig. 8 DR.907.080 Fig. 8A DR.907.081 Fig. 14 DR.907.140 Fig. 14A DR.907.141

Winged / Con alette
Anteriors / Anteriori

Fig. 211 DR.907.211 Fig. 212 DR.907.212

Rubber dam clamps / Uncini per diga

 Fig. A (14,18A) DR.905.001 Molars, deciduous molars and part erupted teeth. Molari, molari decidui e denti parzialmente spuntati.	 Fig. AW (14,18A) DR.905.002 Molars with good gingival retraction. Molari con buona retrazione gengivale.	 Fig. BW (4,5,8,14) DR.905.003 Incisors, canines and bicuspids. Incisivi, canini e bicuspidi.	 Fig. C (6,9,15,212) DR.905.004 Small molars & large bicuspids. Molari piccoli e bicuspidi grandi.	 Fig. DW (2,7) DR.905.005 All Incisors, canines and premolars with limited gingival retraction. Tutti gli incisivi, canini e premolari con retrazione gengivale limitata.	 Fig. E (00,0,2,2A,9,15,18A) DR.905.006 Large molars with deep gingival fit. Grandi molari con inserimento gengivale profondo.	 Fig. EW (00,0,2,2A,9,15,18A) DR.905.007 Very stable molar clamp. Uncino molto stabile per molari.
 Fig. FW (14A) DR.905.008 Small 3rd molars, deciduous molars, bicuspids & canines. Piccoli terzi molari, molari decidui, bicuspidi e canini.	 Fig. G (1,2,2A) DR.905.009 Extended arch version of AW. Versione estesa ad arco di AW.	 Fig. GW (1,2,2A) DR.905.010 Large jaw version of E. Versione di E per mandibole di grandi dimensioni.	 Fig. HW (14W) DR.905.011 Winged clamp for bicuspids. Uncino alato per bicuspidi.	 Fig. JW (26A) DR.905.012 Medium size molar clamp. Uncino medio per molari.	 Fig. PW (90W,WS) DR.905.017 Large, bland molar clamp. Uncino grande per molari.	
 Fig. K (3,4,5,7A,8,10,11,26,7,8A) DR.905.013 Large jaw version of E. Versione di E per mandibole di grandi dimensioni.	 Fig. L (0) DR.905.014 Winged clamp for bicuspids. Uncino alato per bicuspidi.	 Fig. M (2) DR.905.015 Medium size molar clamp. Uncino medio per molari.	 Fig. NW DR.905.016 Large, bland molar clamp. Uncino grande per molari.	 Fig. PW (90W,WS) DR.905.017 Large, bland molar clamp. Uncino grande per molari.		

Restorative

Winged / Con alette
Premolars / Premolari

Fig. 00 DR.906.100 Fig. 0 DR.906.110 Fig. 1 DR.906.120 Fig. 2 DR.906.130 Fig. 2A DR.906.140

Winged / Con alette
Molars / Molari

Fig. 7 DR.906.530 Fig. 8 DR.906.550 Fig. 8A DR.906.560 Fig. 14 DR.906.590 Fig. 14A DR.906.600

Winged / Con alette
Anterior / Anteriori

Fig. 9 DR.906.090 Fig. 212 DR.906.212



Rubber dam clamps tray / **Vassoio porta-uncini**



DR.904.010
Falcon

Rubber dam template / **Dima per diga**

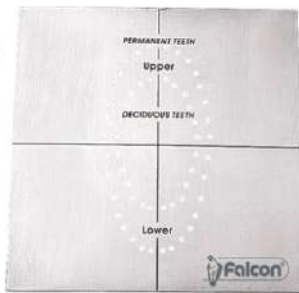

DR.948.000
Autoclavable
Autoclavabile

Plastic anatomical rubber dam frame
Telaio anatomico in plastica per diga



DR.937.020

Rubber dam frames / **Telai per diga**



DR.938.130 130 mm
DR.938.150 150 mm
Young



DR.937.000
Falcon
150 mm



DR.937.010
Falcon

Rubber dam clamp forceps / **Pinze per uncini**

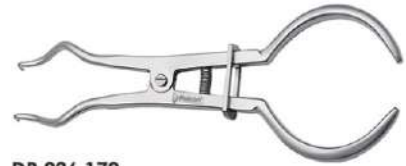

DR.926.170
Brewer



DR.928.170
IV



DR.929.170
Falcon



DR.931.170
Stokes



DR.932.170
Stokes/Palmer

Rubber dam punches / **Pinze per forare la diga**



DR.940.160
Ainsworth



DR.946.160
IV



DR.900.002

Contents/ Contenuto :

- DR.906.100 Clamp / Uncino fig. 00
- DR.906.110 Clamp / Uncino fig. 0
- DR.906.120 Clamp / Uncino fig. 1
- DR.906.130 Clamp / Uncino fig. 2
- DR.906.140 Clamp / Uncino fig. 2A
- DR.906.530 Clamp / Uncino fig. 7
- DR.906.550 Clamp / Uncino fig. 8
- DR.906.560 Clamp / Uncino fig. 8A
- DR.906.090 Clamp / Uncino fig. 9
- DR.906.590 Clamp / Uncino fig. 14
- DR.906.600 Clamp / Uncino fig. 14A
- DR.906.212 Clamp / Uncino fig. 212
- DR.904.010 Clamps tray / Vassoio uncini
- DR.928.170 Forceps / Pinza IV
- DR.938.130 Frame / Telaio Young 130 mm
- DR.940.160 Punch Ainsworth / Pinza per forare Ainsworth
- DR.948.000 Template / Dima per diga
- DZ.430.010 Cover only / Solo coperchio
- DZ.430.040 Tray only / Solo vassoio
- DZ.430.100 Rack / Griglia



DR.900.000

Contents/ Contenuto :

- DR.906.100 Clamp / Uncino fig. 00
- DR.906.110 Clamp / Uncino fig. 0
- DR.906.120 Clamp / Uncino fig. 1
- DR.906.130 Clamp / Uncino fig. 2
- DR.906.140 Clamp / Uncino fig. 2A
- DR.906.530 Clamp / Uncino fig. 7
- DR.906.550 Clamp / Uncino fig. 8
- DR.906.560 Clamp / Uncino fig. 8A
- DR.906.090 Clamp / Uncino fig. 9
- DR.906.590 Clamp / Uncino fig. 14
- DR.906.600 Clamp / Uncino fig. 14A
- DR.906.212 Clamp / Uncino fig. 212
- DR.904.010 Clamps tray / Vassoio uncini
- DR.928.170 Forceps / Pinza IV
- DR.938.130 Frame / Telaio Young 130 mm
- DR.946.160 Punch / Pinza per forare IV
- DR.948.000 Template / Dima per diga
- DZ.430.010 Cover only / Solo coperchio
- DZ.430.040 Tray only / Solo vassoio
- DZ.430.090 Rack / Griglia



DR.900.001

Contents/ Contenuto :

- DR.905.001 Clamp / Uncino fig. A
- DR.905.004 Clamp / Uncino fig. C
- DR.905.006 Clamp / Uncino fig. E
- DR.905.008 Clamp / Uncino fig. FW
- DR.905.009 Clamp / Uncino fig. G
- DR.905.013 Clamp / Uncino fig. K
- DR.905.014 Clamp / Uncino fig. L
- DR.905.015 Clamp / Uncino fig. M
- DR.904.010 Clamps tray / Vassoio uncini
- DR.926.170 Forceps / Pinza Brewer
- DR.938.130 Frame / Telaio Young 130 mm
- DR.940.160 Punch / Pinza per forare Ainsworth
- DR.948.000 Template / Dima per diga
- DZ.430.010 Cover only / Solo coperchio
- DZ.430.040 Tray only / Solo vassoio
- DZ.430.100 Rack / Griglia



DR.900.004

Contents/ Contenuto :

- DR.907.000 True-Flex Clamp / Uncino fig. 00
- DR.907.001 True-Flex Clamp / Uncino fig. 0
- DR.907.020 True-Flex Clamp / Uncino fig. 2
- DR.907.021 True-Flex Clamp / Uncino fig. 2A
- DR.907.070 True-Flex Clamp / Uncino fig. 7
- DR.907.080 True-Flex Clamp / Uncino fig. 8
- DR.907.081 True-Flex Clamp / Uncino fig. 8A
- DR.907.140 True-Flex Clamp / Uncino fig. 14
- DR.907.141 True-Flex Clamp / Uncino fig. 14A
- DR.907.211 True-Flex Clamp / Uncino fig. 211
- DR.907.212 True-Flex Clamp / Uncino fig. 212
- DR.904.010 Clamps tray / Vassoio uncini
- DR.926.170 Forceps Brewer / Pinza Brewer
- DR.938.130 Frame Young / Telaio Young 130 mm
- DR.940.160 Punch Ainsworth / Pinza per forare Ainsworth
- DR.948.000 Template / Dima per diga
- DZ.430.010 Cover only / Solo coperchio
- DZ.430.040 Tray only / Solo vassoio
- DZ.430.100 Rack / Griglia



DR.900.005

Contents/ Contenuto :

- DR.907.000 True-Flex Clamp / Uncino fig. 00
- DR.907.001 True-Flex Clamp / Uncino fig. 0
- DR.907.020 True-Flex Clamp / Uncino fig. 2
- DR.907.021 True-Flex Clamp / Uncino fig. 2A
- DR.907.070 True-Flex Clamp / Uncino fig. 7
- DR.907.080 True-Flex Clamp / Uncino fig. 8
- DR.907.081 True-Flex Clamp / Uncino fig. 8A
- DR.907.140 True-Flex Clamp / Uncino fig. 14
- DR.907.141 True-Flex Clamp / Uncino fig. 14A
- DR.907.211 True-Flex Clamp / Uncino fig. 211
- DR.907.212 True-Flex Clamp / Uncino fig. 212
- DR.904.010 Clamps tray / Vassoio uncini
- DR.928.170 Forceps IV / Pinza IV
- DR.938.130 Frame Young / Telaio Young 130 mm
- DR.946.160 Punch IV / Pinza per forare IV
- DR.948.000 Template / Dima per diga
- DZ.430.010 Cover only / Solo coperchio
- DZ.430.040 Tray only / Solo vassoio
- DZ.430.090 Rack / Griglia

Anaesthesia / Anestesia



Intraligamental Syringes Siringhe Intraligamentali



- Made of 18-8 stainless steel
- Longer life than brass syringes
- No chipping of chrome
- Guaranteed quality
- Sterilizable by any method

SS.2000
Stainless Steel Series

- Prodotte in acciaio Inox 18-8
- Maggior durata rispetto al modello in ottone
- Assenza di cromatura che si può scagliare
- Qualità garantita
- Sterilizzabili con qualsiasi metodo

DA.010.180
Falcon-Ject *Ultima*
Metric Thread
1.8 ml.



- Injects 0.05 ml with every click
- Exact dosage every time
- Supplied with angled and straight tubes
- Suitable for use with all 1.8ml dental cartridges

- Inietta 0,05ml, ad ogni scatto
- Dosaggio esatto ogni volta
- Fornita con terminale dritto o ad angolo
- Adatta con tutte le fiale da 1,8 ml, per uso dentale

DA.020.180
Falcon-Ject
Angled / Ad angolo
Metric Thread
1.8 ml.



- Injects 0.06 ml with every click
- Exact dosage every time
- Suitable for use with all 1.8ml Dental cartridges

- Inietta 0,06 ml ad ogni scatto.
- Dosaggio esatto ogni volta
- Adatta con tutte le fiale da 1,8 ml per uso dentale

DA.021.180
Falcon-Ject
Straight / Dritta
Metric Thread
1.8 ml.



DA.094.180
Swedish Type
Tipo Svedese
Metric Thread
1.8 ml.



DA.040.180
Pistol - Ject
Metric Thread
1.8 ml.



- Injects 0.20 ml with every click
- Exact dosage every time
- Lever action for high injection pressure
- Suitable for use with all 1.8ml dental cartridges

- Inietta 0,20 ml ad ogni scatto.
- Dosaggio esatto ogni volta
- Elevata pressione di iniezione grazie all' azione della leva
- Adatta con tutte le fiale da 1,8 ml per uso dentale

DA.035.000
Autoclavable plastic protection tube
Protezione in plastica autoclavabile





SS•2000
Stainless Steel Series



DA.115.180
Disc System / A Disco
Metric Thread
1.8 ml.

Disc System / A Disco

Dual self aspiration system:
Disc system syringe has dual aspiration feature to achieve self aspiration.
Aspiration before injection:
Insert syringe in tissue and press Thumb disc to achieve aspiration.
Aspiration during injection:
Automatic aspiration occurs whenever pressure on the plunger is released.
Duplica sistema auto aspirante:
La siringa a disco ha duplice effetto auto aspirante
Aspirazione prima dell'iniezione:
Inserire la siringa nel tessuto e premere il disco per ottenere l' aspirazione.
Aspirazione durante l'iniezione:
Al rilascio dello stantuffo si verifica una aspirazione automatica



DA.315.180
Projection System / A Proiezione
Metric Thread
1.8 ml.

Projection System / A Proiezione

Aspiration during injection:
Automatic aspiration occurs whenever pressure on the plunger is released.
Aspirazione durante l'iniezione:
Al rilascio dello stantuffo si verifica una aspirazione automatica



DA.517.180
Type - A
Metric Thread
1.8 ml.

Dual aspiration system, self and manual aspirating syringes
During injection, aspiration can be achieved either manually by retracting the plunger backward or simply releasing pressure on plunger will produce self aspiration.



DA.557.180
Type - C
Metric Thread
1.8 ml.

Siringhe a duplice effetto aspirante, manuale e automatico
Durante l'iniezione si può ottenere l'aspirazione o manualmente sollevando lo stantuffo o semplicemente rilasciando lo stantuffo ciò che darà luogo ad una auto aspirazione.



DA.626.180
Quatro
Metric Thread
1.8 ml.

4 movable hooks securely holds the cartridge for safe aspiration, the syringe also has self aspiration feature.

4 ganci a scomparsa trattengono la fiala per una aspirazione sicura, il modello ha anche caratteristiche autoaspiranti.



DA.726.180
Trio
Metric Thread
1.8 ml.

3 movable hooks securely holds the cartridge for safe aspiration, the syringe also has self aspiration feature.

3 ganci a scomparsa trattengono la fiala per una aspirazione sicura, il modello ha anche caratteristiche autoaspiranti.

SS•2000
Stainless Steel Series

DA.595.180
Euro
Metric Thread
1.8 ml.



DA.635.180
T - Handle / Manico a T
Metric Thread
1.8 ml.



DA.705.180
3 - Ring / 3 - Anelli
Metric Thread
1.8 ml.



DA.801.180
Euro breech loading, ring handle
Caricamento laterale, manico ad anello
Metric Thread
1.8 ml.



DA.806.180
Euro breech loading, T-handle
Caricamento laterale, manico a T
Metric Thread
1.8 ml.





- 30% light weight
- Fully autoclavable
- Attractive and colorful
- Guaranteed quality

feather-lite

- 30% più leggera
- Autoclavabili
- Pratiche
- Qualità garantita

Self Aspiration: How it works

During use, the thumb pressure on the plunger or thumb disc stretches the diaphragm over a small metal projection inside of the syringe nozzle, increasing pressure inside of the cartridge. As the thumb pressure is released, pressure inside the cartridge lessens and aspiration occurs automatically. (Instruction for use are supplied with the product)

Auto aspirazione: Come funziona

Durante l'uso, la pressione esercitata sullo stantuffo o sul disco fa dilatare il diaframma posto sull'estremità della fiala. Questo contribuisce ad aumentare la pressione all'interno delle fiala. Rilasciando lo stantuffo si determina una caduta della pressione che automaticamente si trasforma in aspirazione. (Istruzioni fornite con il prodotto)

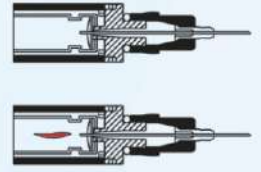

DA.120.180
Disc System / A Disco
Metric Thread
1.8 ml.

Disc System / A Disco

Dual self aspiration system:

Dual system syringe has dual aspiration feature to achieve self aspiration.

Aspiration before injection:

Insert syringe in tissue and press Thumb disc to achieve aspiration.

Aspiration during injection:

Automatic aspiration occurs whenever pressure on the plunger is released.

Duplice sistema auto aspirante:

La siringa a disco ha duplice effetto auto aspirante

Aspirazione prima dell'iniezione:

Inserire la siringa nel tessuto e premere il disco per ottenere l'aspirazione.

Aspirazione durante l'iniezione:

Al rilascio dello stantuffo si verifica una aspirazione automatica



DA.320.180
Projection System / A Proiezione
Metric Thread
1.8 ml.

Projection System / A Proiezione

Aspiration during injection:

Automatic aspiration occurs whenever pressure on the plunger is released.

Aspirazione durante l'iniezione:

Al rilascio dello stantuffo si verifica una aspirazione automatica

Manual aspirating syringes / Siringhe ad aspirazione manuale



DA.536.180
Type - A
Metric Thread
1.8 ml.



DA.605.180
Euro
Metric Thread
1.8 ml.

Caution:
Never disinfect anodized aluminum syringes

Attenzione:
Non disinfettare le siringhe in alluminio anodizzato

Brass Series Syringes Siringhe Serie Ottone

- Made of brass
- Chrome plated
- All Brass series syringes have stainless steel plungers
- Guaranteed quality
- Sterilizable by any method

Brass
SERIES

- Prodotte in ottone
- Cromate
- Tutte le siringhe della serie ottone hanno gli stantuffi in acciaio inox.
- Qualità garantita
- Sterilizzabili con qualsiasi metodo

Intraligamental syringes / Siringhe intraligamentali

- Injects 0.20 ml with every click
- Exact dosage every time
- Lever action for high injection pressure
- Suitable for use with all 1.8ml dental cartridges
- Inietta 0,20 ml ad ogni scatto.
- Dosaggio esatto ogni volta
- Elevata pressione di iniezione grazie all' azione della leva
- Adatta con tutte le fiale da 1,8 ml per uso dentale



DA.060.180
Pistol - Ject
Metric Thread
1.8 ml.



DA.095.180
Swedish Type
Tipo Svedese
Metric Thread
1.8 ml.

- Injects 0.06 ml with every click
- Exact dosage every time
- Suitable for use with all 1.8ml Dental cartridges
- Inietta 0,06 ml ad ogni scatto.
- Dosaggio esatto ogni volta
- Adatta con tutte le fiale da 1,8 ml per uso dentale

Self-aspirating syringe / Siringa autoaspirante



DA.145.180
Disc System / A Disco
Metric Thread
1.8 ml.

Manual aspirating syringes / Siringhe ad aspirazione manuale



DA.520.180
Type A / Tipo A
1.8 ml.



DA.560.180
Type - C / Tipo C
Metric Thread
1.8 ml.



Special aspiration tip for use with 1.8ml cartridges with hole. (May also be used with traditional cartridges. (without aspiration).

Per aspirazione con cartucce 1,8 ml munite di stantuffo con speciale incavo. (Possono essere usate anche con cartucce tradizionali. (Senza aspirazione)

DA.561.180
P-Ject
Metric Thread
1.8 ml.





DA.620.180
Euro
Metric Thread
1.8 ml.



DA.721.180
3 - Ring / 3 Anelli
Metric Thread
1.8 ml.



DA.735.180
2 - Ring / 2 Anelli
Metric Thread
1.8 ml.



DA.820.180
Euro breech loading, ring handle
Caricamento laterale,
manico ad anello
Metric Thread
1.8 ml.



DA.821.180
Euro breech loading, T - handle
Caricamento laterale, manico a T
Metric Thread
1.8 ml.

Needle Re-cappers
Base Riponi Ago

SS•2000
 Stainless Steel Series

Falcon Needle Re-Cappers are the ideal way to prevent needle stick injuries when recapping needles. Place the upturned needle cap into Falcon Re-Capper and re-sheathing becomes a simple one hand procedure.

Il Falcon Needle Re-capper (base riponi ago) consente di riporre l' ago nel suo cappuccio dopo l'uso evitando spiacevoli ferite. Porre il cappuccio con l'apertura rivolta verso l'alto nel Falcon Needle Re-capper, Il re-instrimento dell' ago nel suo cappuccio diviene un' operazione sicura da eseguire con una sola mano.



DA.980.000
 Needle Re-Capper



DA.990.000
 Needle Re-Capper Ultima

Extraction / Estrazione





DE.999.002
 Set of 9 pieces / Serie di 9 pezzi

Contents / Contenuto:

- DE.750.331** Extracting forceps fig. 33A / Pinza per estrazione fig. 33A
- DE.750.511** Extracting forceps fig. 51A / Pinza per estrazione fig. 51A
- DE.750.671** Extracting forceps fig. 67A / Pinza per estrazione fig. 67A
- DE.750.790** Extracting forceps fig. 79 / Pinza per estrazione fig. 79
- DE.086.020** Elevator Flohr left fig. 2 / Leva Flohr sinistra fig. 2
- DE.086.030** Elevator Flohr right fig. 3 / Leva Flohr destra fig. 3
- DE.025.060** Elevator Bein 3mm fig. 6 / Leva Bein 3mm fig. 6
- BM.147.140** Falcon-Grip Needle holder Mathieu 140mm TC / Falcon-Grip porta aghi Mathieu 140mm TC
- BM.065.160** Falcon-Grip Needle holder Mayo-Hegar 160mm TC / Falcon-Grip porta aghi Mayo-Hegar 160mm TC



DE.999.001
 Set of 9 pieces / Serie di 9 pezzi

Contents / Contenuto:

- DE.750.331** Extracting forceps fig. 33A / Pinza per estrazione fig. 33A
- DE.750.511** Extracting forceps fig. 51A / Pinza per estrazione fig. 51A
- DE.750.671** Extracting forceps fig. 67A / Pinza per estrazione fig. 67A
- DE.750.790** Extracting forceps fig. 79 / Pinza per estrazione fig. 79
- DE.086.020** Elevator Flohr left fig. 2 / Leva Flohr sinistra fig. 2
- DE.086.030** Elevator Flohr right fig. 3 / Leva Flohr destra fig. 3
- DE.025.060** Elevator Bein 3mm fig. 6 / Leva Bein 3mm fig. 6
- DE.270.125** Elevator Winter left fig. 12L / Leva Winter sinistra fig. 12L
- DE.270.127** Elevator Winter right fig. 12R / Leva Winter destra fig. 12R



Century-line 1908 - 2008

- Tips are made of special grade stainless steel and are TIN coated:

Benefits

- Edge stays sharp longer
- Longer life than ordinary stainless steel elevators
- Improved smoothness for easy sliding in and out
- Non toxic TIN coating

- Ergonomic autoclavable plastic handle
- Available in new and existing best selling models

- **Punte realizzate con acciai speciali e rivestite con Nitruo di Titanio**

Vantaggi

- Maggiore durata dell'affilatura
- Maggiore durata rispetto alle leve in acciaio tradizionale
- Le superfici lisce rendono l'intervento piu' agevole
- Rivestimento TIN atossico

- **Manico ergonomico in plastica autoclavabile**
- **Disponibili in modelli nuovi e tradizionali**



Falcon Serrated / Zigrinate

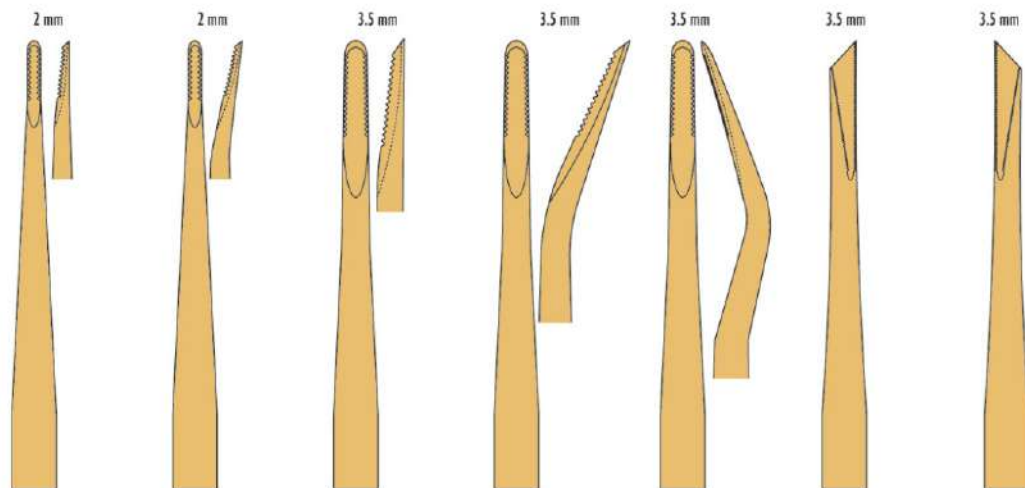

Fig. 1 DE.095.017 Fig. 2 DE.095.027 Fig. 1 DE.096.017 Fig. 3 DE.096.037 Fig. 4 DE.096.047 Fig. 6 DE.096.067 Fig. 7 DE.096.077

DE.997.001 Set of 7 Falcon serrated elevators / Set di 7 leve Falcon zigrinate

Falcon Luxators

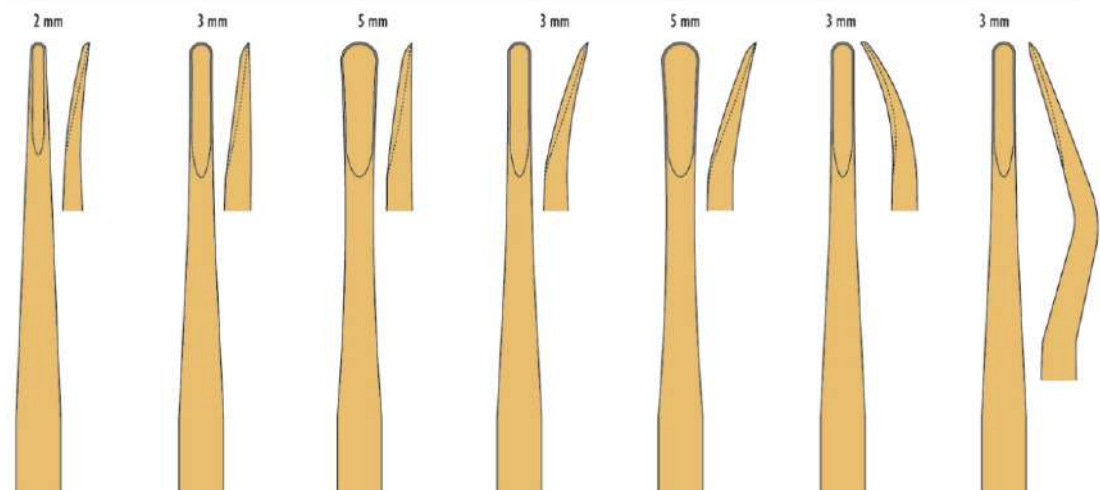
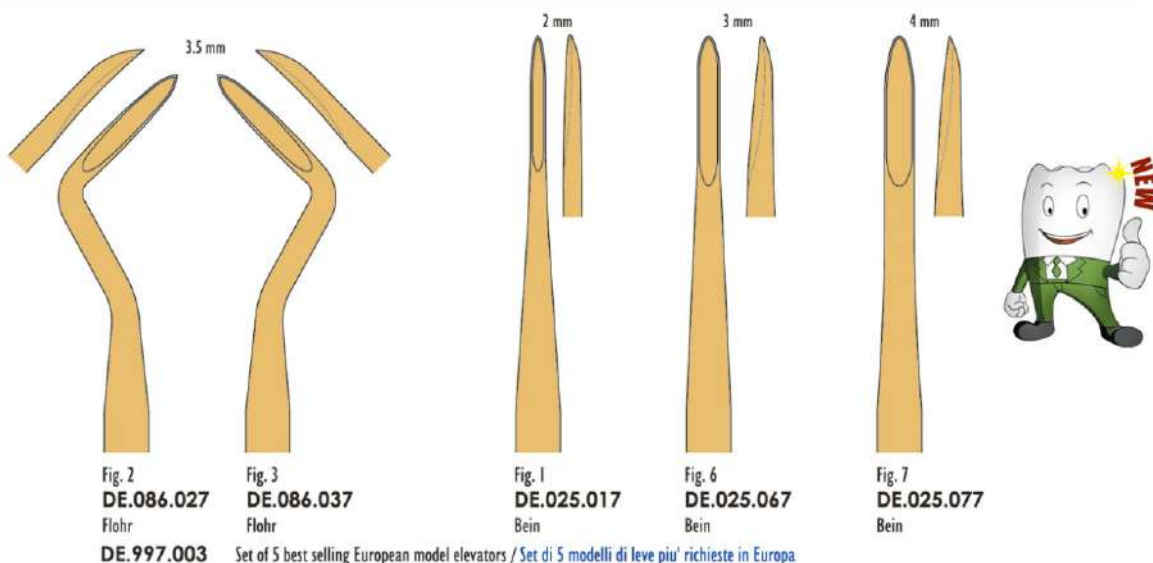

Fig. 1 DE.920.017 Fig. 2 DE.920.027 Fig. 3 DE.920.037 Fig. 4 DE.920.047 Fig. 5 DE.920.057 Fig. 6 DE.920.067 Fig. 7 DE.920.077

DE.997.002 Set of 7 Falcon luxators / Set di 7 leve Falcon luxators



European models / Mod. Europei



British models / Mod. Inglesi

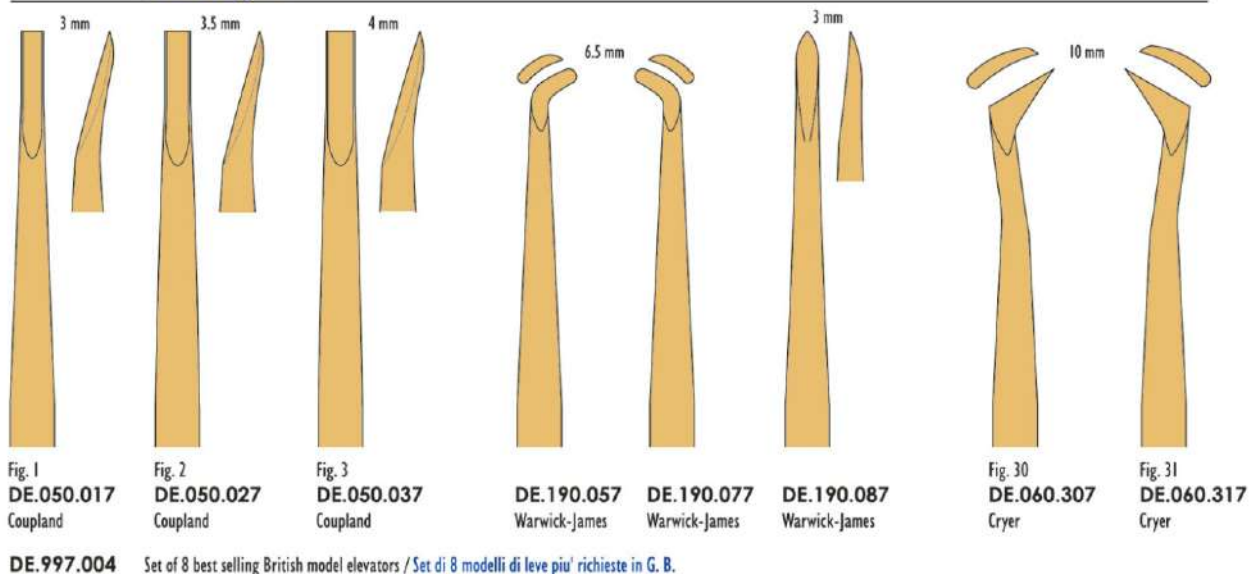

Root tip elevators / Leve per frammenti e radici

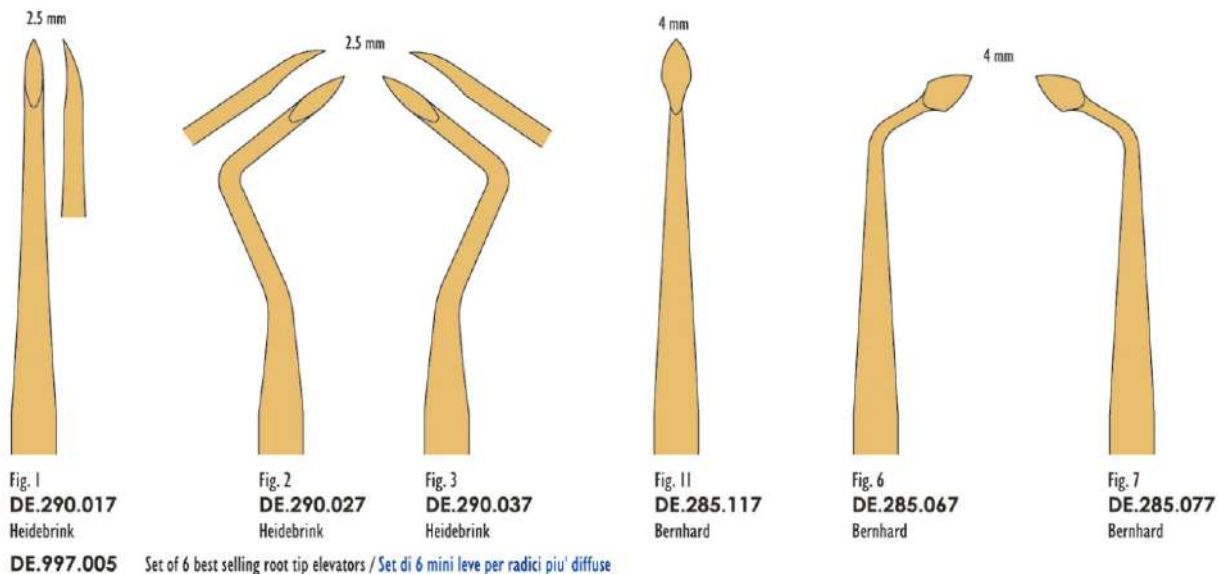



Falcon Luxators



Fig. 1
DE.920.010



Fig. 2
DE.920.020



Fig. 3
DE.920.030



Fig. 4
DE.920.040



Fig. 5
DE.920.050



Fig. 6
DE.920.060



Fig. 7
DE.920.070



DE.920.000
Set of 7 / Serie di 7

Bein



Fig. 1
DE.030.010



Fig. 2
DE.030.020



Fig. 3
DE.030.030



Fig. 4
DE.030.040



Fig. 5
DE.030.050



Fig. 6
DE.030.060

Apical



Fig. 301
DE.015.301

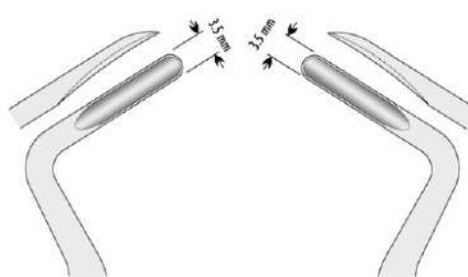

Fig. 302
DE.015.302
Left / Sinistra

Fig. 303
DE.015.303
Right / Destra



Fig. 304
DE.015.304

Seldin



Fig. 34
 DE.155.340



Fig. 34S
 DE.155.347

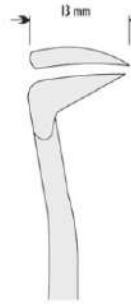

Fig. 1L
 DE.155.015
 Left / Sinistra



Fig. 1R
 DE.155.017
 Right / Destra



Fig. 4L
 DE.155.045
 Left / Sinistra



Fig. 4R
 DE.155.047
 Right / Destra



Cryer

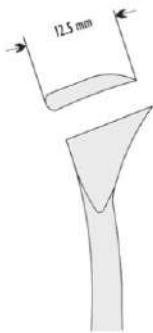

Fig. 25
 DE.070.250
 Left / Sinistra

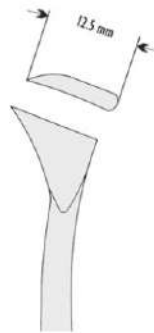

Fig. 26
 DE.070.260
 Right / Destra



Fig. 31
 DE.070.310
 Left / Sinistra

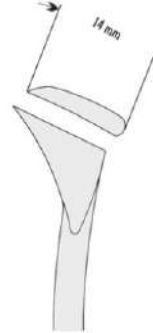

Fig. 32
 DE.070.320
 Right / Destra



Fig. 44
 DE.070.440
 Left / Sinistra



Fig. 45
 DE.070.450
 Right / Destra

Coupland



Fig. 1
 DE.050.011



Fig. 2
 DE.050.021



Fig. 3
 DE.050.031

Schmeckebier

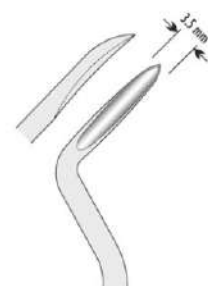

Fig. 4
 DE.153.040
 Left / Sinistra

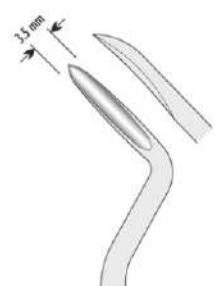

Fig. 5
 DE.153.050
 Right / Destra



**Fig. 1
DE.025.010**



**Fig. 2
DE.025.020**



**Fig. 3
DE.025.030**



**Fig. 4
DE.025.040**



**Fig. 5
DE.025.050**



**Fig. 6
DE.025.060**



**Fig. 7
DE.025.070**



**Fig. 8
DE.025.080**



**Fig. 9
DE.025.090**



**Fig. 10
DE.025.100**



**Fig. 1
DE.026.010**



**Fig. 2
DE.026.020**



**Fig. 3
DE.026.030**



**Fig. 1
DE.027.010**



**Fig. 2
DE.027.020**



**Fig. 3
DE.027.030**



**Fig. 1
DE.028.010
Bayonet distal
Distale a Baionetta**



**Fig. 2
DE.028.020
Bayonet distal
Distale a Baionetta**



**Fig. 3
DE.028.030
Bayonet distal
Distale a Baionetta**



**Fig. 1
DE.029.010
Bayonet mesial
Mesiale a Baionetta**



**Fig. 2
DE.029.020
Bayonet mesial
Mesiale a Baionetta**



**Fig. 3
DE.029.030
Bayonet mesial
Mesiale a Baionetta**

Root Elevators
Leve Per Radici



Flohr



Fig. 1
DE.086.010

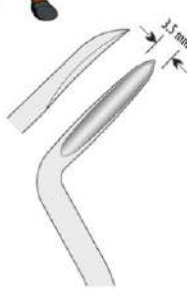

Fig. 2
DE.086.020
Left / Sinistra

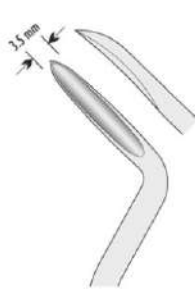

Fig. 3
DE.086.030
Right / Destra

Friedman



Fig. 1
DE.089.010



Fig. 2
DE.089.020

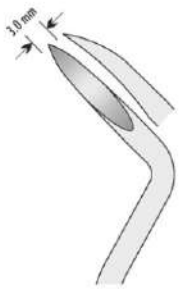

Fig. 3
DE.089.030

Lindo-Levian



Fig. LLL
DE.115.010



Fig. LLM
DE.115.020



Fig. LLS
DE.115.030



Fig. LLL
DE.117.010



Fig. LLM
DE.117.020



Fig. LLS
DE.117.030



Fig. LLM
DE.118.021
Bayonet distal
Distale a Baionetta



Fig. LLM
DE.118.022
Bayonet mesial
Mesiale a Baionetta

Hyllin



Fig. 1
DE.100.010



Fig. 2
DE.100.020

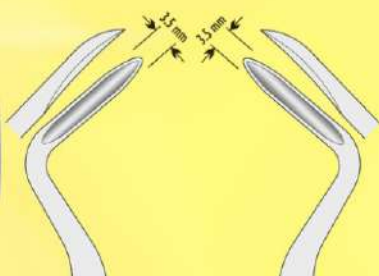

Fig. 3
DE.100.030
Left / Sinistra



Fig. 4
DE.100.040
Right / Destra

Bein



Fig. 1
DE.025.011



Fig. 6
DE.025.061



Fig. 7
DE.025.071

Flohr



Fig. 1
DE.086.011

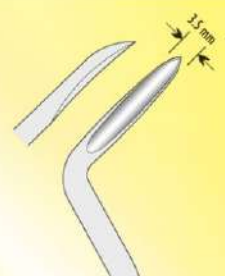

Fig. 2
DE.086.021
Left / Sinistra



Fig. 3
DE.086.031
Right / Destra

Extraction



Falcon

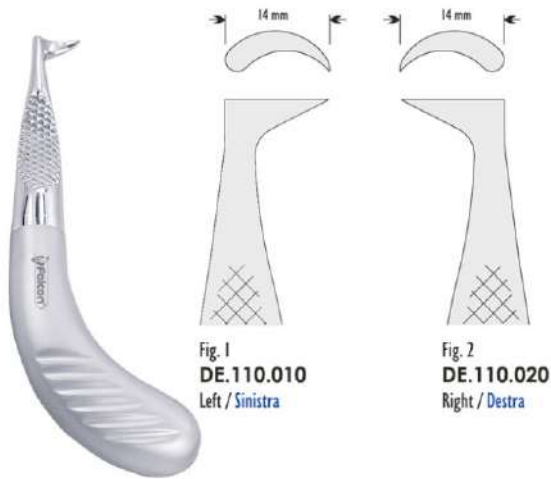

Fig. 1
DE.110.010
Left / Sinistra

Fig. 2
DE.110.020
Right / Destra

Schlemmer



Fig. 1
DE.154.010

Fig. 2
DE.154.020

Coleman / London Hospital

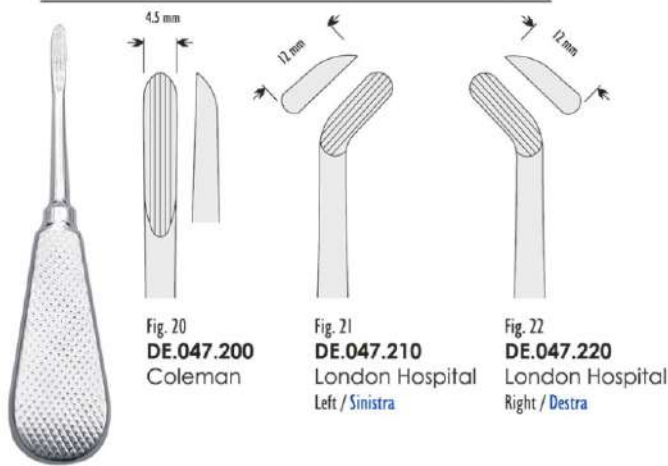
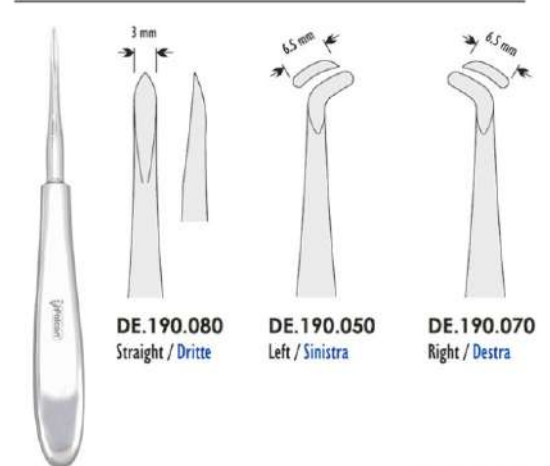

Fig. 20
DE.047.200
Coleman

Fig. 21
DE.047.210
London Hospital
Left / Sinistra

Fig. 22
DE.047.220
London Hospital
Right / Destra

Warwick-James



DE.190.080
Straight / Dritte

DE.190.050
Left / Sinistra

DE.190.070
Right / Destra

Heidebrink
Root tip picks / Leve per frammenti di radici



CLASSIC-LITE
8 mm hollow handle
Manico vuoto da 8 mm

Fig. 1
DE.290.011

Fig. 2
DE.290.021
Left / Sinistra

Fig. 3
DE.290.031
Right / Destra

Fig. 13/14
DE.275.145
Double ended / Doppio

Fig. 1
DE.290.010

Fig. 2
DE.290.020
Left / Sinistra

Fig. 3
DE.290.030
Right / Destra

Extraction

Root Elevators
Leve Per Radici

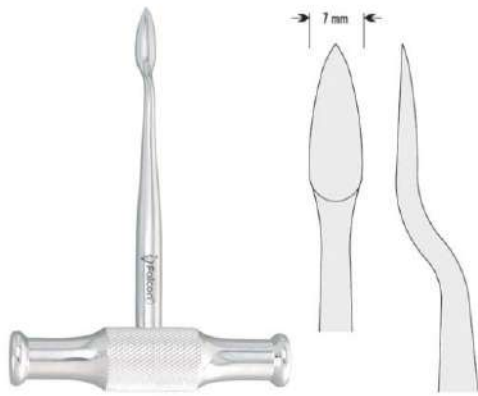
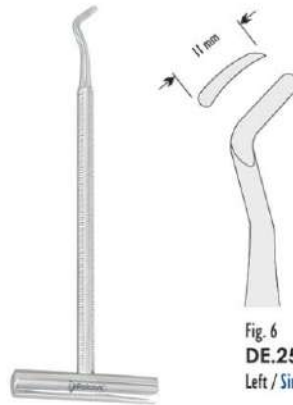

Fig. 1
DE.247.010
Lecluse



Potts

Fig. 6
DE.255.060
Left / Sinistra

Fig. 7
DE.255.070
Right / Destra

Winter



Fig. 1L
DE.270.015
Left / Sinistra



Fig. 1R
DE.270.017
Right / Destra

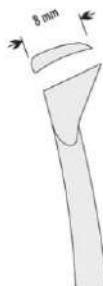

Fig. 11L
DE.270.115
Left / Sinistra



Fig. 11R
DE.270.117
Right / Destra



Fig. 12L
DE.270.125
Left / Sinistra



Fig. 12R
DE.270.127
Right / Destra



Fig. 13L
DE.270.135
Left / Sinistra



Fig. 13R
DE.270.137
Right / Destra



Fig. 14L
DE.270.145
Left / Sinistra

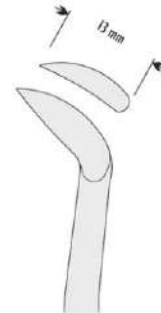

Fig. 14R
DE.270.147
Right / Destra

Walter F. Barry



Fig. 320
DE.265.320
Left / Sinistra



Fig. 321
DE.265.321
Right / Destra

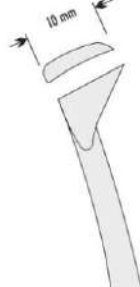

Fig. 322
DE.265.322
Left / Sinistra

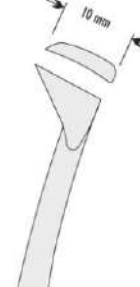

Fig. 323
DE.265.323
Right / Destra

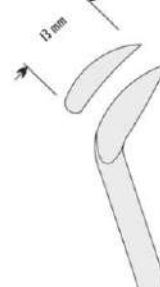

Fig. 350
DE.265.350
Left / Sinistra

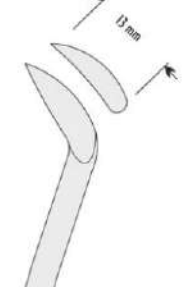

Fig. 351
DE.265.351
Right / Destra

Extraction



DE.929.010
110 mm



Fig. 0
DE.930.000

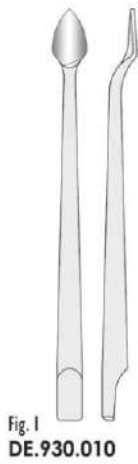

Fig. 1
DE.930.010



Fig. 2
DE.930.020



Fig. 3
DE.930.030

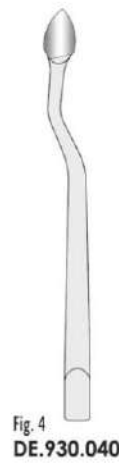

Fig. 4
DE.930.040

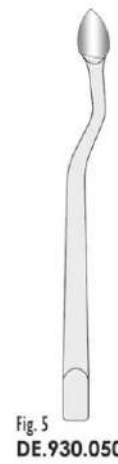

Fig. 5
DE.930.050

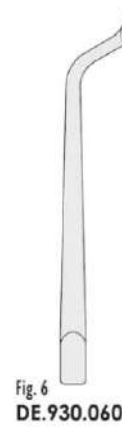

Fig. 6
DE.930.060



Fig. 7
DE.930.070

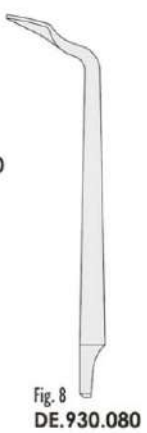

Fig. 8
DE.930.080

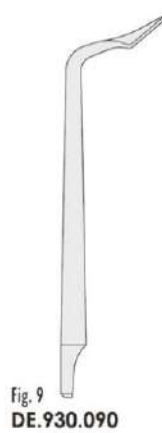

Fig. 9
DE.930.090

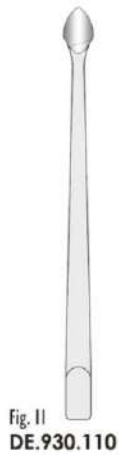

Fig. 11
DE.930.110

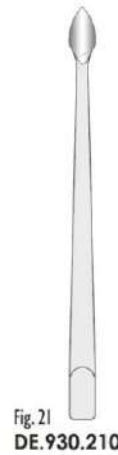

Fig. 21
DE.930.210

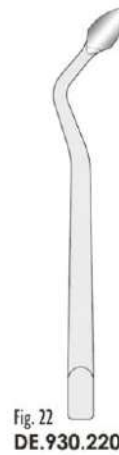

Fig. 22
DE.930.220



Fig. 23
DE.930.230



Fig. 24
DE.930.240



Fig. 25
DE.930.250



Fig. 26
DE.930.260

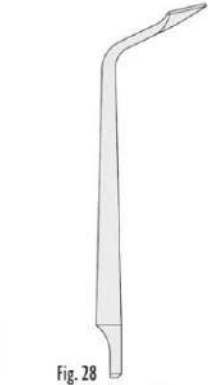

Fig. 27
DE.930.270



Fig. 28
DE.930.280



Fig. 29
DE.930.290

Syndesmotomes Sets / Serie di Sindesmotomi



DE.931.010

Set of 11 tips (fig. 0-11) + 1 handle in box
Serie di 11 punte (fig. 0-11) + manico con vassoio

DE.931.020

Set of 20 tips (fig. 0-29) + 1 handle in box
Serie di 20 punte (fig. 0-29) + manico con vassoio

Chompret



Fig. 1
DE.925.010



Fig. 2
DE.925.020



Fig. 3
DE.925.030



Fig. 4
DE.925.040

500 SERIES
Children Pattern / Per Bambini



Fig. 135
DE.500.137
Lower Premolars
Premolari Inferiori



Fig. 225
DE.500.227
Lower Molars
Molari Inferiori



Fig. 305
DE.500.307
Upper Roots
Radici Superiori



Fig. 335
DE.500.337
Lower Roots
Radici Inferiori



Fig. 37
DE.500.370
Upper Incisors
Incisivi Superiori



Fig. 38
DE.500.380
Lower Incisors and Canines
Incisivi e Canini Inferiori



Fig. 39
DE.500.390
Upper Molars
Molari Superiori



Fig. 39L
DE.500.395
Upper Molars, Left
Molari Superiori, Sinistri



Fig. 39R
DE.500.397
Upper Molars, Right
Molari Superiori, Destri



Fig. 515
DE.500.517
Upper Roots
Radici Superiori



DE.500.001
Set of 10 / Serie di 10

- DE.500.137 Fig. 135
- DE.500.227 Fig. 225
- DE.500.307 Fig. 305
- DE.500.337 Fig. 335
- DE.500.370 Fig. 37
- DE.500.380 Fig. 38
- DE.500.390 Fig. 39
- DE.500.395 Fig. 39L
- DE.500.397 Fig. 39R
- DE.500.517 Fig. 515



650 SERIES
Children Pattern / Per Bambini

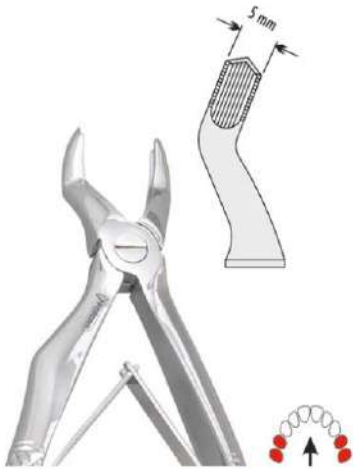

Fig. 3
DE.650.030
Upper Molars
Molari Superiori



Fig. 5
DE.650.050
Lower Incisors
Incisivi Inferiori



Fig. 6
DE.650.060
Lower Molars
Molari Inferiori



Fig. 7
DE.650.070
Lower Roots
Radici Inferiori



Fig. 515
DE.650.517
Upper Roots
Radici Superiori



Fig. 137
DE.651.370
Upper Incisors
Incisivi Superiori



Fig. 139
DE.651.390
Upper Premolars
Premolari Superiori



DE.650.000
Set of 7 / Serie di 7

- DE.650.030 Fig. 3
- DE.650.050 Fig. 5
- DE.650.060 Fig. 6
- DE.650.070 Fig. 7
- DE.650.517 Fig. 515
- DE.651.370 Fig. 137
- DE.651.390 Fig. 139

750 SERIES
 Standard Grip / Manico Standard



800 SERIES
 Anatomical Grip / Manico Anatomico



Better Grip
 Easy Cleaning
 Più Grip
 Maggiore igiene

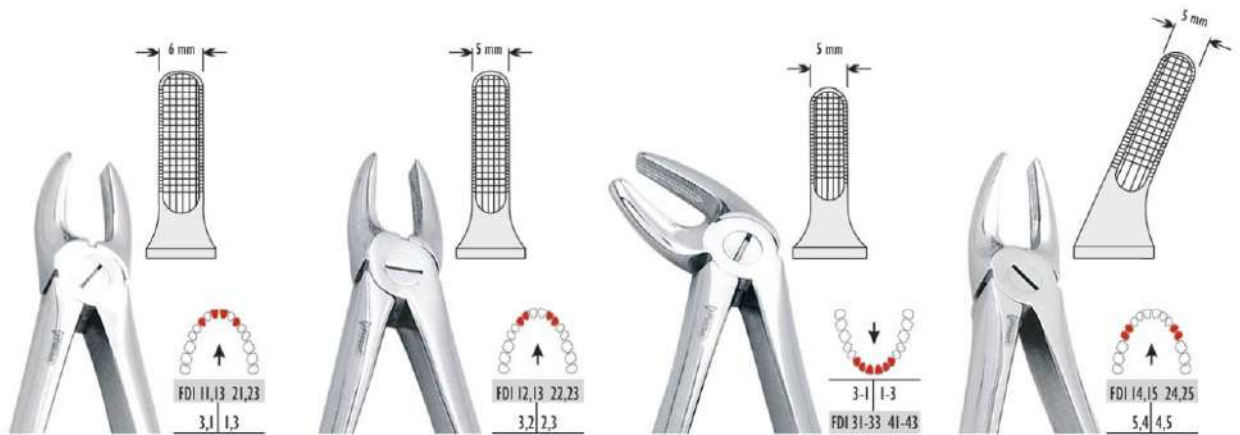

Fig.	Standard	Anatomical	Upper Centrals & Canines/Cuspids Incisivi e Canini Superiori
Fig. 1	DE.750.010	DE.800.010	
Fig. 2	DE.750.020	DE.800.020	Upper Laterals & Canines/Cuspids Incisivi e Canini Superiori
Fig. 4	DE.750.040	DE.800.040	Lower Incisors & Canines/Cuspids Incisivi e Canini Inferiori
Fig. 7	DE.750.070	DE.800.070	Upper Premolars/Bicuspids Premolari Superiori

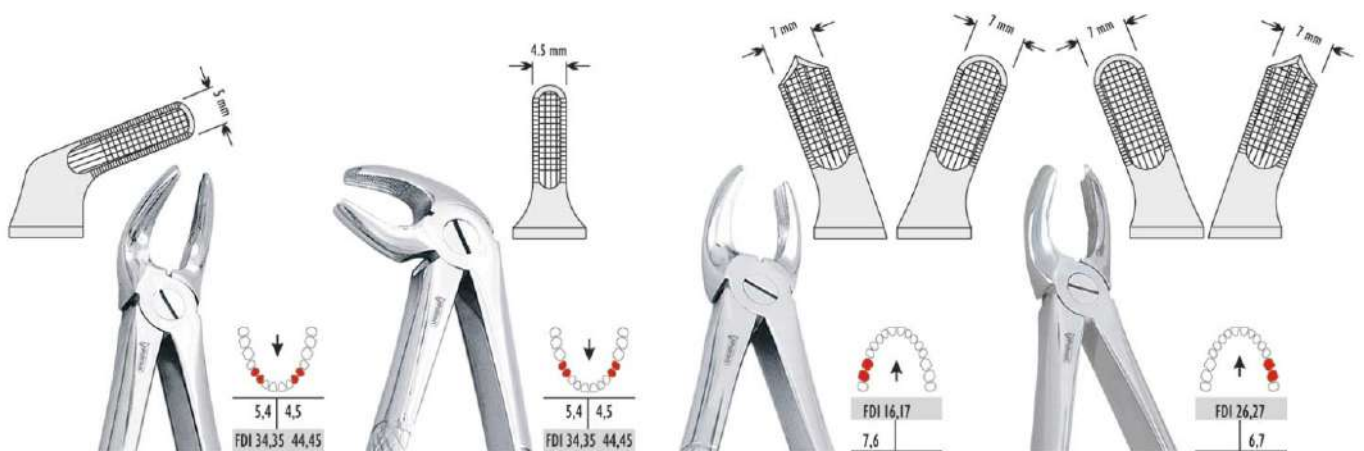

Fig.	Standard	Anatomical	Lower Premolars/Bicuspids Premolari Inferiori
Fig. 8	DE.750.080	DE.800.080	
Fig. 13	DE.750.130	DE.800.130	Lower Premolars/Bicuspids Premolari Inferiori
Fig. 17	DE.750.170	DE.800.170	Upper Molars, Right Molari Superiori, Destri
Fig. 18	DE.750.180	DE.800.180	Upper Molars, Left Molari Superiori, Sinistri



750 SERIES
Standard Grip / Manico Standard



DE.750.000
Set of 10 / Serie di 10



- DE.750.010 Fig. 1
- DE.750.070 Fig. 7
- DE.750.130 Fig. 13
- DE.750.170 Fig. 17
- DE.750.180 Fig. 18
- DE.750.220 Fig. 22
- DE.750.331 Fig. 33A
- DE.750.511 Fig. 51A
- DE.750.671 Fig. 67A
- DE.750.790 Fig. 79



Fig. 18A



Fig. 19



Fig. 21



Fig. 22

Standard	DE.750.181	DE.750.190	DE.750.210	DE.750.220
Anatomical	DE.800.181	DE.800.190	DE.800.210	DE.800.220

Upper Molars
Molari Superiori

Upper Third Molars
Denti Del Giudizio Superiori

Lower Molars
Molari Inferiori

Lower Molars
Molari Inferiori



Fig. 23



Fig. 24

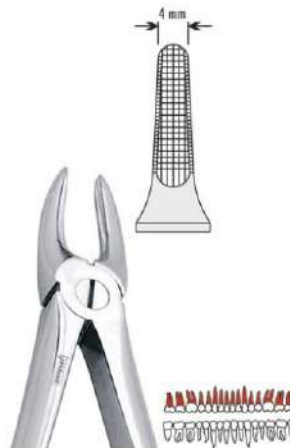

Fig. 29



Fig. 29N

Standard	DE.750.230	DE.750.240	DE.750.290	DE.750.295
Anatomical	DE.800.230	DE.800.240	DE.800.290	DE.800.295

Lower Molars, Right
Molari Inferiori, Destri

Lower Molars, Left
Molari Inferiori, Sinistri

Upper Roots
Radici Superiori

Upper Roots
Radici Superiori

750 SERIES
Standard Grip / Manico Standard



800 SERIES
Anatomical Grip / Manico Anatomico



Better Grip
Easy Cleaning
Più Grip
Maggiore igiene



	Fig. 33	Fig. 33A	Fig. 33M	Fig. 45
Standard	DE.750.330	DE.750.331	DE.750.335	DE.750.450
Anatomical	DE.800.330	DE.800.331	DE.800.335	DE.800.450
	Lower Roots Radici Inferiori	Lower Roots Radici Inferiori	Lower Roots Radici Inferiori	Lower Roots Radici Inferiori

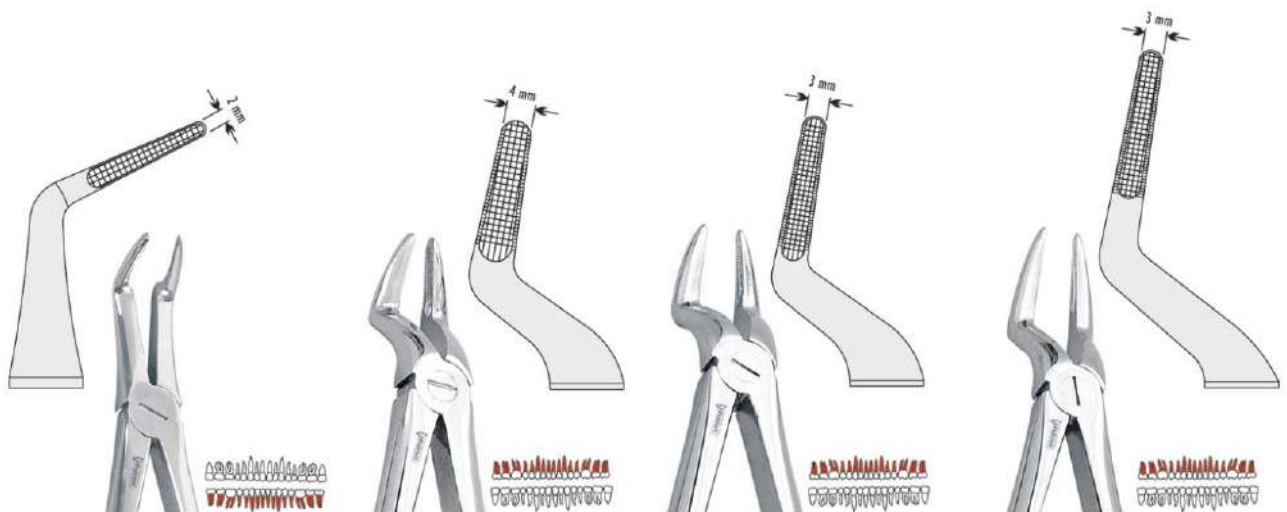
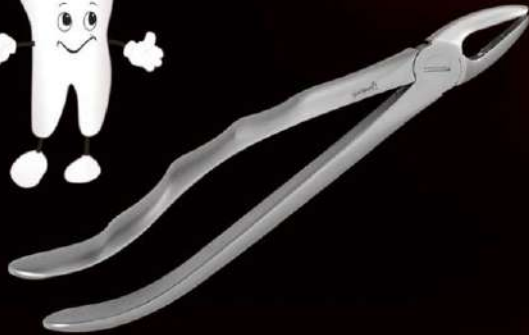
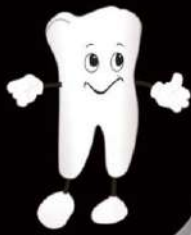

	Fig. 46L	Fig. 51	Fig. 51A	Fig. 51M
Standard	DE.750.463	DE.750.510	DE.750.511	DE.750.515
Anatomical	DE.800.463	DE.800.510	DE.800.511	DE.800.515
	Lower Roots Radici Inferiori	Upper Roots Radici Superiori	Upper Roots Radici Superiori	Upper Roots Radici Superiori



800 SERIES
Anatomical Grip / Manico Anatomico



- DE.800.010 Fig. 1
- DE.800.070 Fig. 7
- DE.800.130 Fig. 13
- DE.800.170 Fig. 17
- DE.800.180 Fig. 18
- DE.800.220 Fig. 22
- DE.800.331 Fig. 33A
- DE.800.511 Fig. 51A
- DE.800.671 Fig. 67A
- DE.800.790 Fig. 79

DE.800.000
Set of 10 / Serie di 10

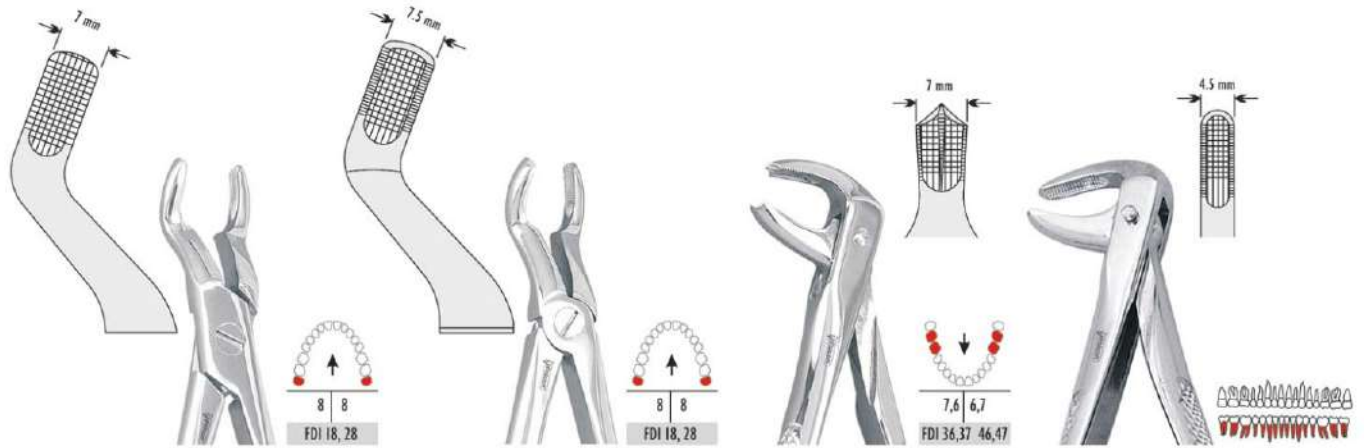

Fig. 67

Fig. 67A

Fig. 73

Fig. 74

Standard	DE.750.670	DE.750.671	DE.750.730	DE.750.740
Anatomical	DE.800.670	DE.800.671	DE.800.730	DE.800.740
	Upper Third Molars Denti Del Giudizio Superiori	Upper Third Molars Denti Del Giudizio Superiori	Lower Molars Molari Inferiori	Lower Roots Radici Inferiori

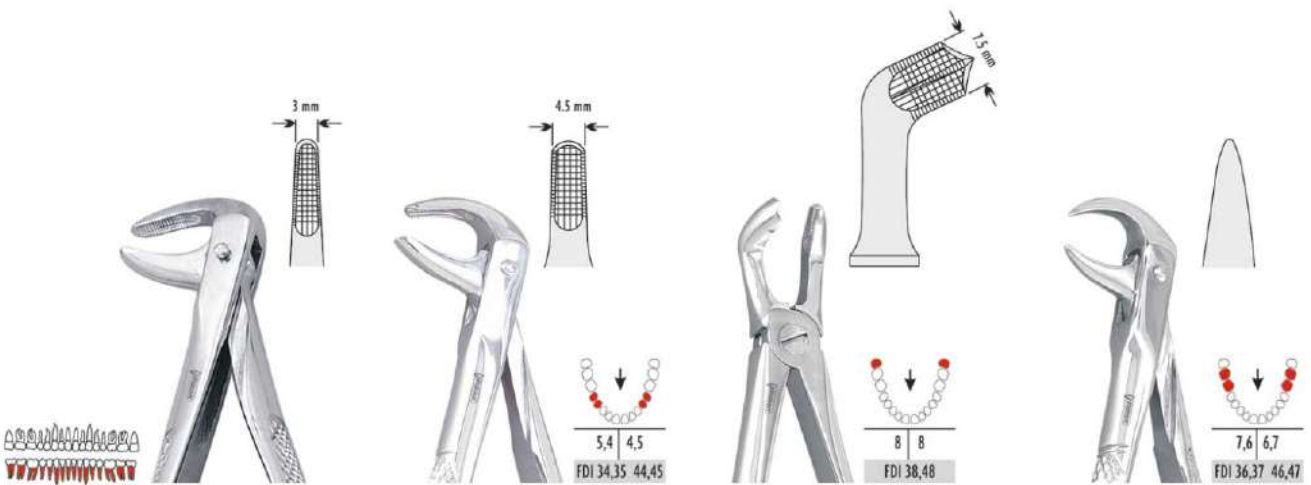

Fig. 74N

Fig. 75

Fig. 79

Fig. 86A

Standard	DE.750.743	DE.750.750	DE.750.790	DE.750.861
Anatomical	DE.800.743	DE.800.750	DE.800.790	DE.800.861
	Lower Roots Radici Inferiori	Lower Premolars/Bicuspsids Premolari Inferiori	Lower Third Molars Denti Del Giudizio Inferiori	Lower Molars Molari Inferiori

750 SERIES
Standard Grip / Manico Standard



800 SERIES
Anatomical Grip / Manico Anatomico



Better Grip
Easy Cleaning
Più Grip
Maggiore igiene



Fig. 86C



Fig. 87



Fig. 145

Standard	DE.750.863	DE.750.870	DE.751.450
Anatomical	DE.800.863	DE.800.870	DE.801.450

Lower Molars
Molari Inferiori

Lower Molars
Molari Inferiori

Very Fine Roots, Lower
Radici, Molto Fini, Inferiori



Fig. 151 1/2

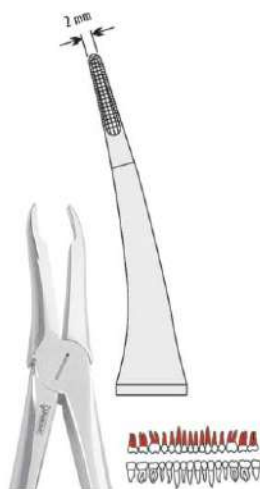

Fig. 349



Fig. 359

Standard	DE.751.510	DE.753.490	DE.753.590
Anatomical	DE.801.510	DE.803.490	DE.803.590

Very Fine Roots, Upper
Radici, Molto Fini, Superiori

Very Fine Roots, Upper
Radici, Molto Fini, Superiori

Very Fine Roots, Lower
Radici, Molto Fini, Inferiori



Titanium
Titanio

825 SERIES
Anatomical Grip / Manico Anatomico



Fig. 1
DE.825.010
Upper Centrals and Canines/Cuspsids
Incisivi e Canini Superiori



Fig. 7
DE.825.070
Upper Premolars/Bicuspsids
Premolari Superiori



Fig. 13
DE.825.130
Lower Premolars/Bicuspsids
Premolari Inferiori



Fig. 17
DE.825.170
Upper Molars, Right
Molari Superiori, Destri

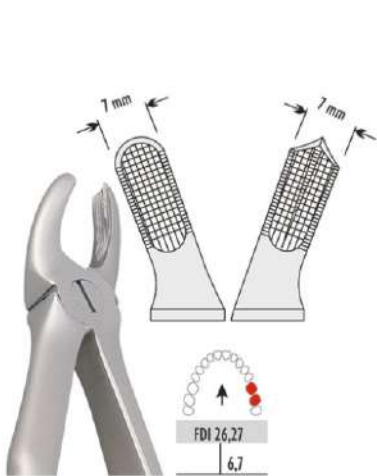

Fig. 18
DE.825.180
Upper Molars, Left
Molari Superiori, Sinistri



Fig. 22
DE.825.220
Lower Molars
Molari Inferiori



Fig. 33A
DE.825.331
Lower Roots
Radici Inferiori.



Fig. 51A
DE.825.511
Upper Roots
Radici Superiori



Fig. 67A
DE.825.671
Upper Third Molars
Denti Del Giudizio Superiori

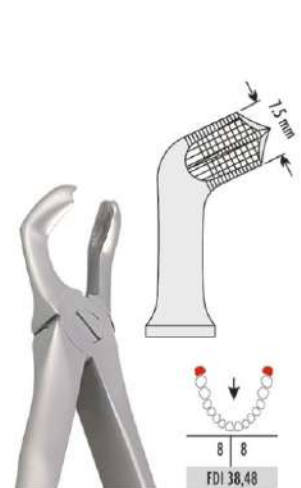
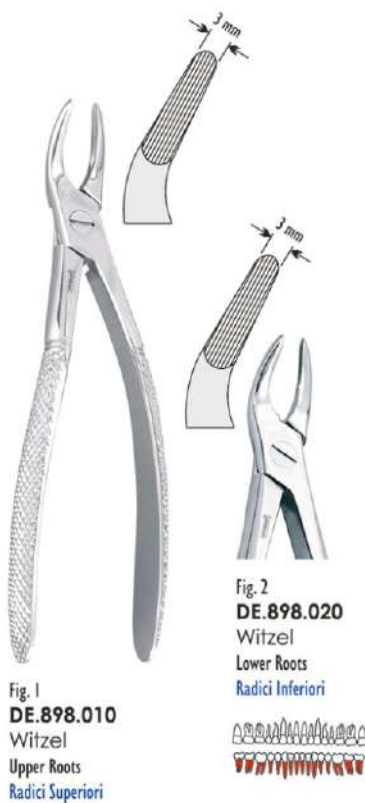
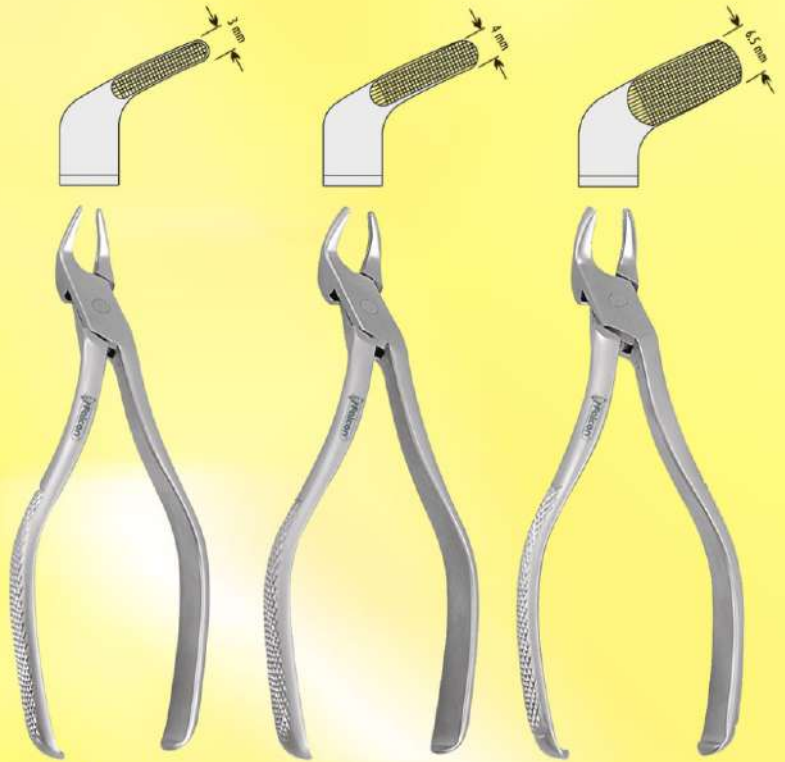
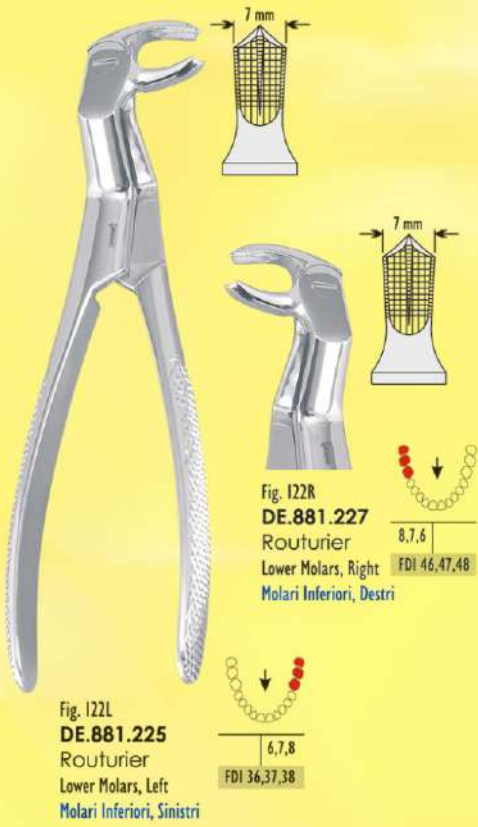

Fig. 79
DE.825.790
Lower Third Molars
Denti Del Giudizio Inferiori



DE.825.000
Set of 10 / Serie di 10

- DE.825.010 Fig. 1
- DE.825.070 Fig. 7
- DE.825.130 Fig. 13
- DE.825.170 Fig. 17
- DE.825.180 Fig. 18
- DE.825.220 Fig. 22
- DE.825.331 Fig. 33A
- DE.825.511 Fig. 51A
- DE.825.671 Fig. 67A
- DE.825.790 Fig. 79



Surgery / Chirurgia





Surgery tips / Punte per chirurgia



Type E / Tipo E



BS1
 DS.002.010



BS2
 DS.002.020



BS3
 DS.002.030



BS4
 DS.002.040



BS5
 DS.002.050



SL1
 DS.003.010



SL2
 DS.003.020



SL3
 DS.003.030



SL4
 DS.003.040



LC1
 DS.004.010

Accessories / Accessori



Torque wrench / Chiave tubolare
 DP.004.010



Tips holder / Porta punte
 DP.004.020



Micro scalpel and micro mirror handles
Manici per micro lame e per micro specchietti

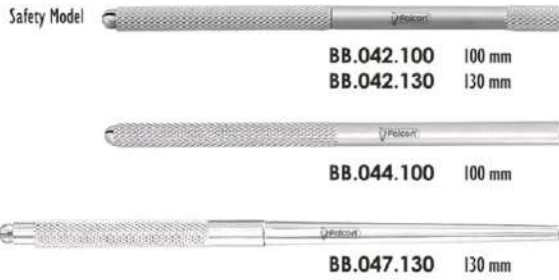

Micro scalpel blades / Micro lame per bisturi

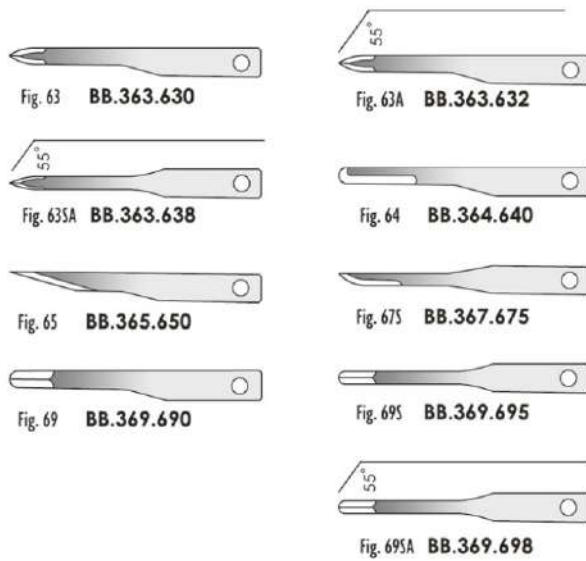

Micro forceps stainless steel
Micro pinzette in acciaio inox

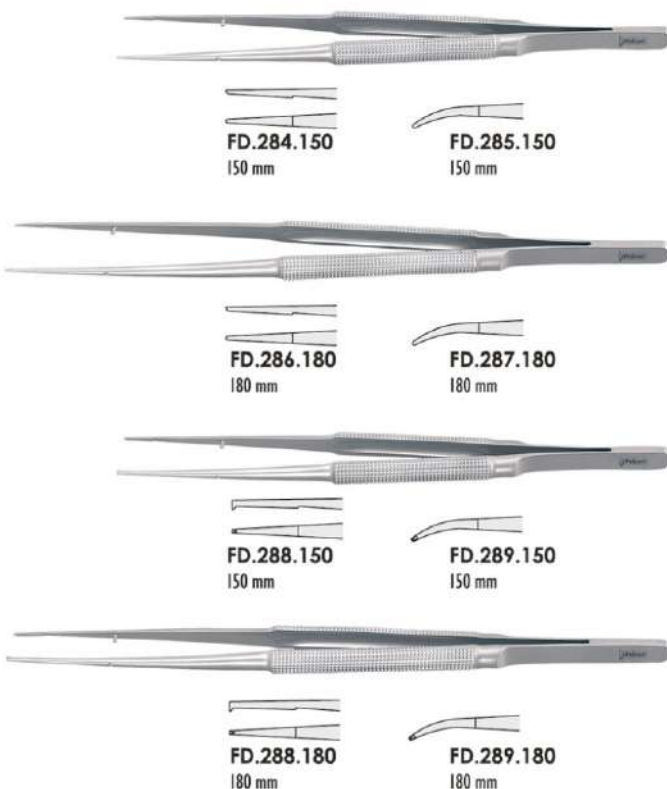

Titanium micro forceps
Micro pinzette in Titanio

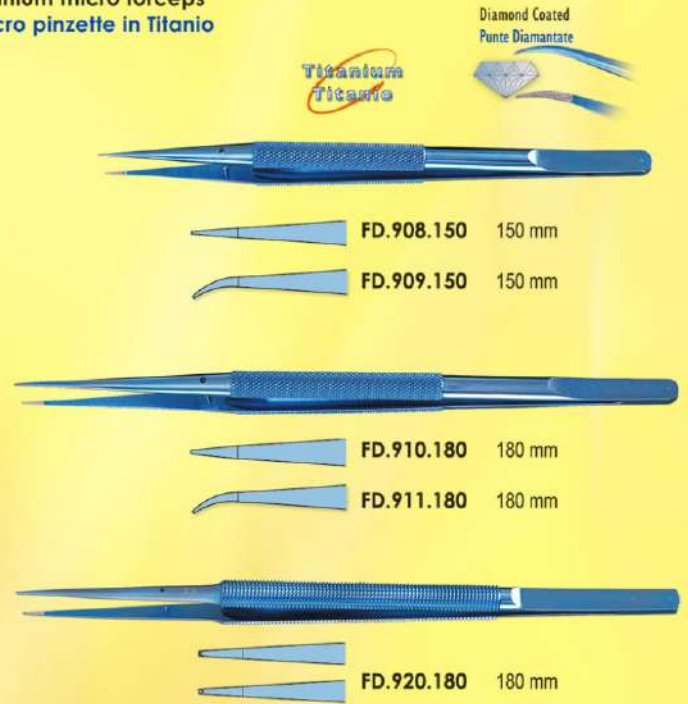

Titanium micro needle holders with scissors
Micro porta aghi con forbici in Titanio



Titanium micro needle holders
Micro porta aghi in Titanio



Surgery

Micro needle holders stainless steel
Micro porta aghi in acciaio inox



Falcon
GRIP With tungsten carbide inserts
Con inserti al carburo di tungsteno



FD.258.010
150 mm

FD.259.010
150 mm

FD.258.030
150 mm

FD.259.030
150 mm



FD.258.020
180 mm

FD.259.020
180 mm

FD.258.040
180 mm

FD.259.040
180 mm

Micro needle holders stainless steel
Micro porta aghi in acciaio inox



FD.242.150
150 mm

FD.243.150
150 mm



FD.246.180
180 mm

FD.247.180
180 mm

Micro scissors stainless steel
Micro forbici in acciaio inox

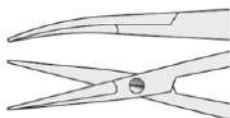

FD.252.180
180 mm

Micro scissors for ligature,
one blade serrated
Micro forbici per legature
con una lama zigrinata

Titanium micro scissors with stainless steel tips
Micro forbici in Titanio con lame in acciaio inox

Titanium
Titanio

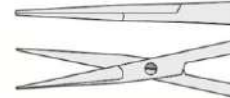

FD.960.155
155 mm

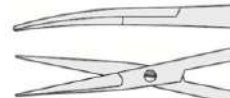

FD.961.155
155 mm



FD.966.180
180 mm

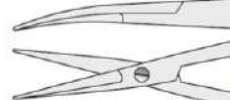

FD.967.180
180 mm



FD.968.180
180 mm

Micro scissors stainless steel
Micro forbici in acciaio inox



FD.100.150
150 mm



FD.101.150
150 mm



FD.250.180
180 mm



FD.251.180
180 mm



Depth measuring probes / Sonde graduate per misurazione



Easy COLOR



DS.800.010
Titanium tip, silicone handle and laser marked
Punta in titanio, manico in silicone, marcato con laser



DS.800.013
TIN coated tip, plastic handle and laser marked
Rivestito in TIN, manico in plastica, marcato con laser

Century-line 1908 - 2008

Bone thickness gauges / Spessimetri per osso



DS.803.010
Falcon



Fig. 1
DS.804.010
Castroviejo



Fig. 2
DS.804.020
Castroviejo



Fig. 3
DS.804.030
Castroviejo



Fig. 4
DS.804.040
Castroviejo

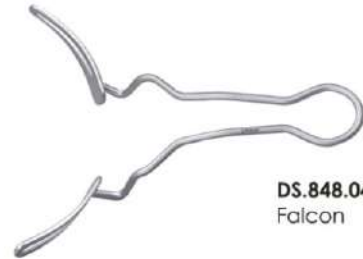

Fig. 5
DS.804.050
Castroviejo

Implant retractors / Divaricatori per implantologia



DS.848.020
Falcon



DS.848.040
Falcon

Sinus rongeur

Delicate bone cutting forceps for opening the sinus window 4mm bite, TIN coated

Pinza per rialzo del seno

Pinza rivestita in TIN per aprire con delicatezza una finestra nel seno, bite 4 mm.



DS.929.010
Falcon

Ratchet screw driver handles / Chiavi a cricchetto

- Hexagonal head
- Clockwise for tightening
- Anti-clockwise for removing
- Without torque
- Testa esagonale
- Avvitare - senso orario
- Svitare - in senso antiorario
- Posizione di folle



DS.970.010



DS.970.020

Century-line 1908 - 2008

TIN coated and laser marked / Marcati con laser e rivestimento in nitruro di titanio



Osteotomes
Osteotomi

Bone tampers
Compattatori per osso

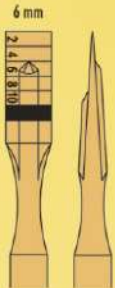

DS.812.060

Step osteotome
for secure splitting in steps
Step osteotomo
per frammentazione in steps.

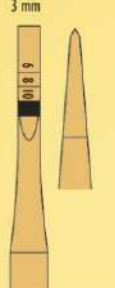
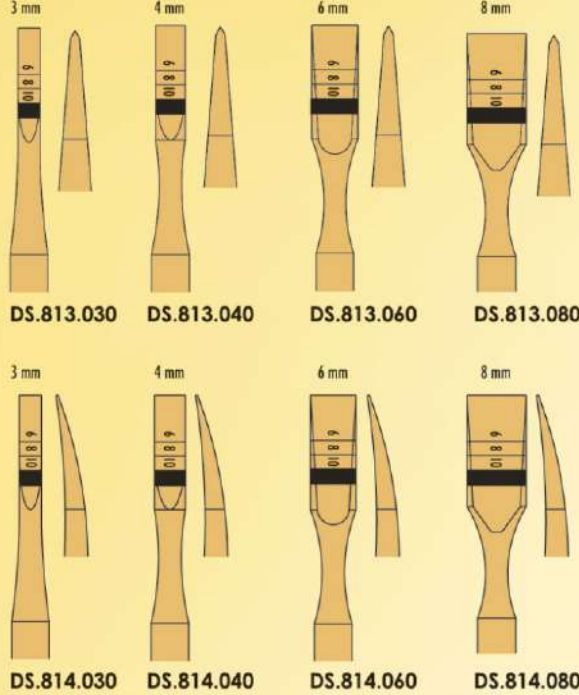

DS.813.030

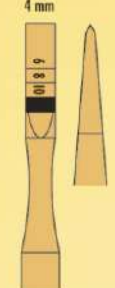

DS.813.040

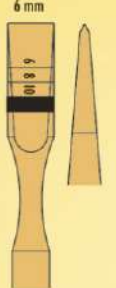

DS.813.060

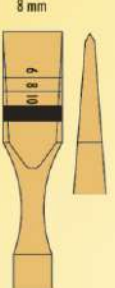

DS.813.080

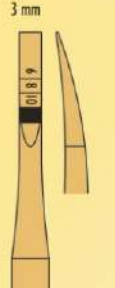

DS.814.030

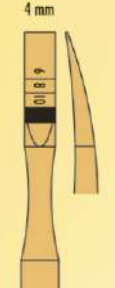

DS.814.040

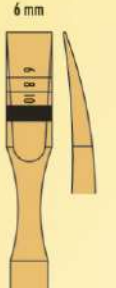

DS.814.060

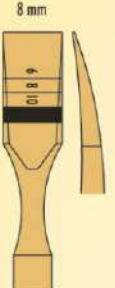

DS.814.080



DS.928.040

DS.928.070

For separating sinus window
from surrounding bone
Per separare la finestra nel seno
dall'osso circostante

Osteotomes / Osteotomi

Mallets / Martelli

Light weight for use with implant osteotomes / Leggeri per uso con osteotomi per implantologia

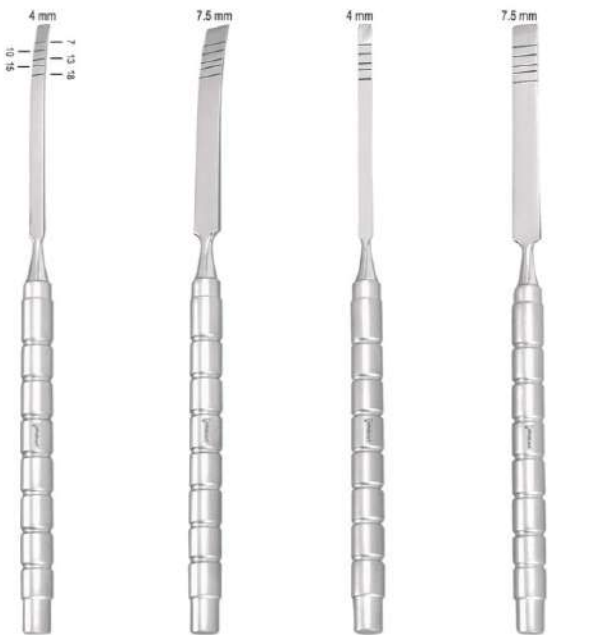

DS.825.040
Falcon
175 mm



DS.825.075
Falcon
175 mm



DS.826.040
Falcon
175 mm



DS.826.075
Falcon
175 mm



DS.273.190
Falcon
190 mm

DS.274.200
Falcon
200 mm

DS.273.010
Spare plastic disks, pair
Coppia dischi di ricambio

DS.274.010
Spare plastic disks, pair
Coppia dischi di ricambio





Century-line 1908 - 2008

TIN coated bone grafting instruments / Strumenti rivestiti in TIN per la triturazione dell'osso

Titanium Nitride is hypoallergenic. As such it is an ideal material for coating instruments destined for implantology on account of a number of benefits:

- 100% safe when used for bone splitting, punching and grafting.
- highly polished, mirror finish surfaces so that less force is required during bone condensing, punching and splitting
- totally non stick so that no material is left to adhere to the surface of the instrument and placement of bone graft is quicker
- the extremely smooth surfaces of TIN coating allows for easier cleaning/decontamination

Il nitrato di titanio è ipoallergenico. Come tale è un materiale ideale per il rivestimento di strumenti destinati all'implantologia per i numerosi benefici tra cui:

- sicurezza al 100% quando usati per sezionare, frazionare e tritare l'osso.
- le superfici altamente levigate richiedono di applicare meno forza durante le fasi di condensazione, frazionamento e triturazione dell'osso
- le superfici a specchio risultano totalmente non aderenti per cui frammenti di materiale non aderiscono allo strumento e quindi non rallentano la procedura
- le superfici molto lucide consentono una più facile pulizia/sterilizzazione.

Bone mill

- Designed by **Giuliano Lorenzetti**, President of Falcon Medical Italia Srl.
- Simple and practical design
- Supplied with two interchangeable crushing heads to allow it to be used for either mechanical grinding or manual crushing by hammer
- Registered Design



DS.850.000

Trituratore per osso

- Disegnato da **Giuliano Lorenzetti**, presidente Falcon Medical Italia Srl.
- Design semplice e pratico
- Fornito con due elementi intercambiabili per consentirne l'uso come trituratore meccanico o frantumatore manuale con martello.
- Registered Design



Bone well / Mortaio per osso



DS.853.010

TIN coated bone block clamps

To hold and stabilize block graft against recipient site while placing screws. Slotted tips act as a guide for precise drilling.

Pinze riposizionatrice di osso rivestita in TIN

Per posizionare e trattenere le membrane in sede durante l'inserimento delle viti. Le punte scanalate fanno da guida per forare con precisione.



DS.866.010
Anterior / Anteriore



DS.866.020
Posterior / Posteriore

Bone injectors / Iniettori per osso



Fig. 1
DS.855.010



Fig. 2
DS.855.020



Fig. 3
DS.855.030



Fig. 4
DS.855.040





Bone collector / Raccoglitore di osso



DS.854.000



DS.854.010
 Disposable stainless steel cartridge
 Cartuccia in acciaio inox monouso
 Pack of 10 pieces / Confezione di 10 pz.

Applicators for bone grafting material / Applicatori di osso triturato

Century-line 1908 - 2008 TIN coated
Rivestimento in nitruro di titanio



DS.863.013 Applicator / Applicatore



DS.864.013 Applicator and compactor / Applicatore e compattatore

Compactors / Compattatori

CLASSIC-LITE 6 mm Hollow handle
Manico vuoto da 6 mm



Century-line 1908 - 2008 TIN coated
Rivestimento in nitruro di titanio



Century-line 1908 - 2008

CLASSIC-LITE



DS.865.013



DS.865.015



DS.865.023



DS.865.025

Membrane placement instruments / Strumenti per il posizionamento della membrana



DS.867.013



DS.868.010 110 mm



Bone condensing osteotomes Tapered convex tips

In case of soft bone structure, bone condensers are used for lateral condensation to achieve bone stability in closed sinus elevation technique. Convex tips minimize the risk of perforation when lifting the Schneider's membrane



Laser marked at 2mm intervals
Intervalli di 2 mm. marcati con Laser

Safety band at 10mm
Indicatore di sicurezza a 10 mm.

TIN coated
Rivestimento in nitruro di titanio

Laser marked size
Misura marcata con Laser



Osteotomi per condensare l'osso Punte conico/convesse

I condensatori di osso vengono usati per condensare lateralmente strutture ossee poco consistenti nelle tecniche di rialzo del seno mascellare. Le punte convesse minimizzano il rischio di perforazione durante il rialzo della membrana di Schneider.

Century-line 1908 - 2008 ■ TIN coated
Rivestimento in nitruro di titanio



Sinus lift osteotomes

Straight concave tips

Used for closed sinus elevation technique, concave semi-sharp tips lift sinus floor and additional bone towards cranial to achieve stable foundation for the placement of implants.



Laser marked at 2mm intervals
 Intervalli di 2 mm. marcati con Laser

Safety band at 10mm
 Indicatore di sicurezza a 10 mm.

TIN coated
 Rivestimento in nitruro di titanio

Laser marked size
 Misura marcata con Laser



Osteotomi per il rialzo del seno

Punte dritte concave

Usati con la tecnica di elevazione del seno 'closed sinus elevation'. Le punte concave semiaffilate asportano particelle di osso che vengono spinte verso l'alto in modo da aumentare il rialzo dello stesso.

Century-line 1908 - 2008 ■ TIN coated
 Rivestimento in nitruro di titanio





Sinus lift curettes / Curette per il rialzo del seno

CLASSIC-LITE 8 mm hollow handle
Manico vuoto da 8 mm



Century-line 1908 - 2008 **TIN coated**
Rivestimento in nitruro di titanio



Sinus lift elevators / Scollatori per rialzo del seno



CLASSIC-LITE 8 mm hollow handle
 Manico vuoto da 8 mm



Century-line 1908 - 2008 **TIN coated**
 Rivestimento in nitruro di titanio



CLASSIC-LITE

Century-line 1908 - 2008



Fig. 1
DS.873.015
 Falcon



Fig. 1
DS.873.013
 Falcon



Fig. 2
DS.873.025
 Falcon



Fig. 2
DS.873.023
 Falcon



Fig. 3
DS.873.035
 Falcon

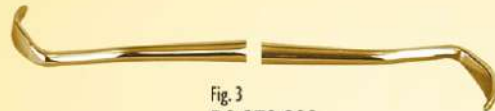

Fig. 3
DS.873.033
 Falcon



Fig. 4
DS.873.045
 Falcon



Fig. 4
DS.873.043
 Falcon



Fig. 5
DS.873.055
 Falcon



Fig. 5
DS.873.053
 Falcon



Fig. 6
DS.873.065
 Falcon



Fig. 6
DS.873.063
 Falcon



Fig. 7
DS.873.075
 Falcon

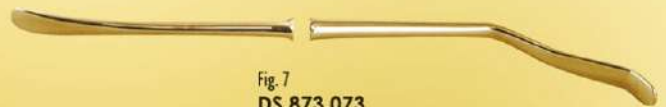

Fig. 7
DS.873.073
 Falcon



Fig. 8
DS.873.085
 Falcon



Fig. 8
DS.873.083
 Falcon



Century-line 1908 - 2008

Periotome / Periotomo



Fig. 1 DS.846.013

Implant periosteal elevators and raspatories / Scollaperiostei per implantologia



Fig. 1 DS.845.013



Fig. 2 DS.845.023
Sharp-Blunt / Affilato-Smusso



Fig. 1 DS.838.013
Atraumatic papilla elevator / Leva atraumatica per papilla

Easy
COLOR

Titanium implant periosteal elevators / Scollaperiostei per implantologia in titanio



Fig. 1 DS.832.011 Busar



Fig. 3 DS.839.031 Prichard

CLASSIC-LITE

8 mm Ho/low handle
Manico vuoto da 8 mm

Implant periosteal elevators / Scollaperiosteo per implantologia



Fig. 1 DS.832.015 Busar



Fig. 9A DS.830.091 Allen



25 mm

Fig. 25 DS.828.250 170 mm



Fig. 9 DP.666.094 Molt



Fig. 3 DP.665.034 Prichard



Fig. 15 DP.635.155 Freer



Fig. 16 DP.635.165 Freer



Fig. 14 DP.637.145 Goldman-Fox



Fig. 20 DP.640.205 Hirschfield



Fig. 1 DP.643.015 Hopkins



Fig. 2 DP.643.025 Hopkins



Fig. 3 DP.658.035 Mead/West

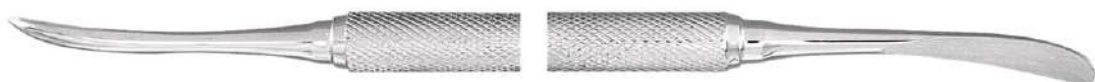

Fig. 9 DP.660.095 Molt



Fig. 3 DP.665.035 Prichard



Fig. 9 DP.660.090 Molt



Elevators and raspatories
Scollaperiostei ed elevatori



Pocket markers
Pinzette per marcare le tasche



Gingivectomy knives
Bisturi per gengivectomia



SOFT LINE INSTRUMENTS
soft and sure grip

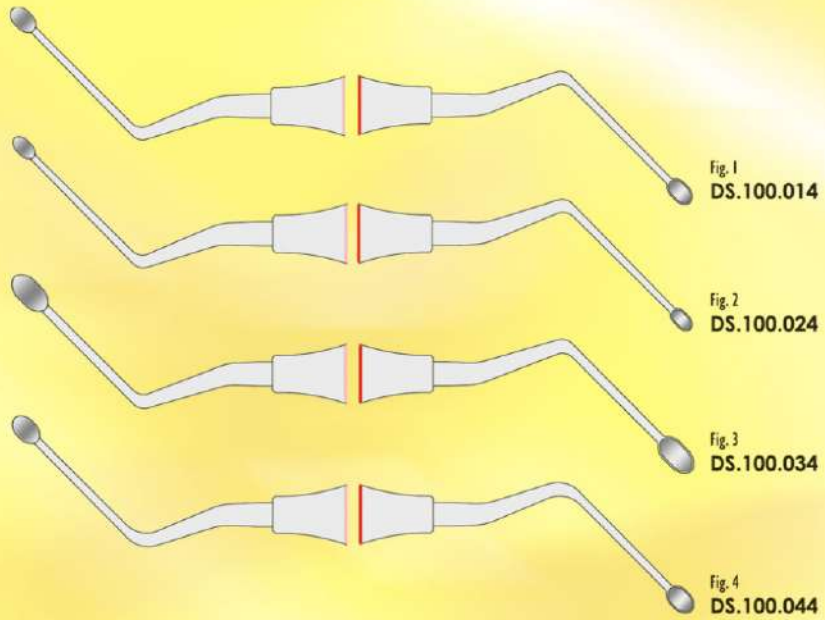

Classic-8
5.5 mm solid handle
Manico pieno da 5.5 mm

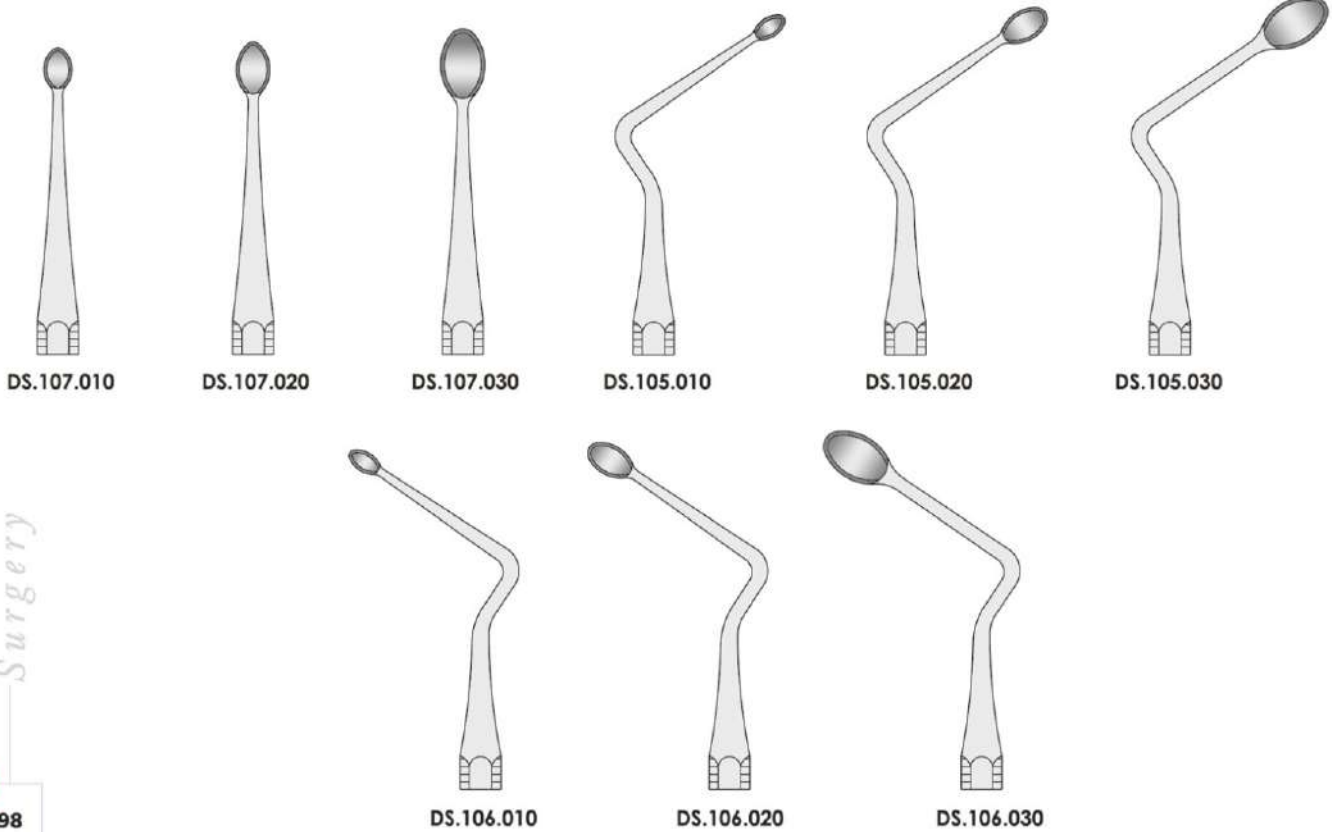

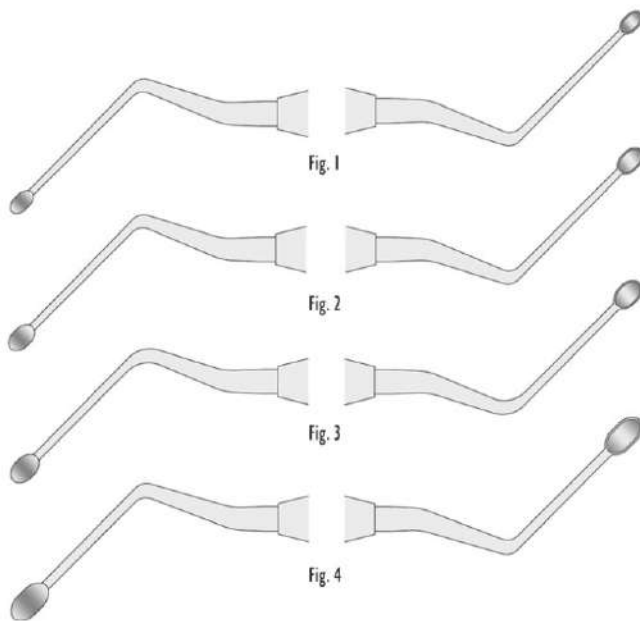

	Classic Round 6 mm solid handle Manico pieno da 6 mm	CLASSIC-LITE 8 mm hollow handle Manico vuoto da 8 mm
Fig. 1	DS.100.010	DS.100.015
Fig. 2	DS.100.020	DS.100.025
Fig. 3	DS.100.030	DS.100.035
Fig. 4	DS.100.040	DS.100.045

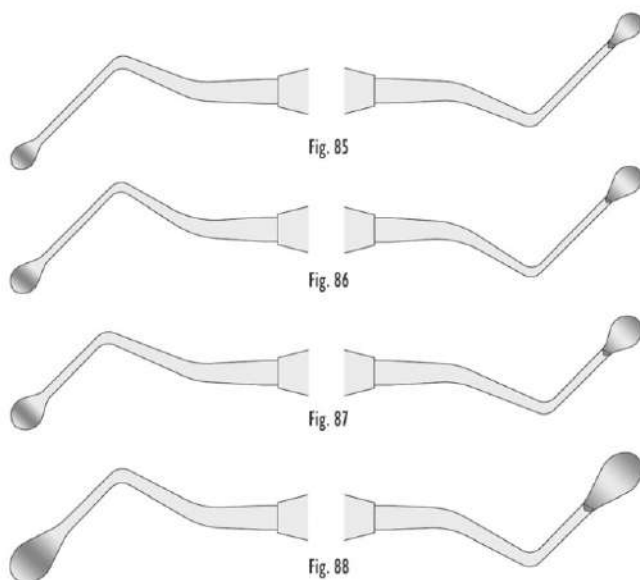

	Classic Round 6 mm solid handle Manico pieno da 6 mm	CLASSIC-LITE 8 mm hollow handle Manico vuoto da 8 mm
Fig. 85	DS.110.850	DS.110.855
Fig. 86	DS.110.860	DS.110.865
Fig. 87	DS.110.870	DS.110.875
Fig. 88	DS.110.880	DS.110.885

Bone curettes / Cucchiai alveolari

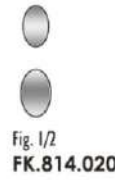
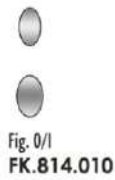
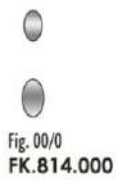
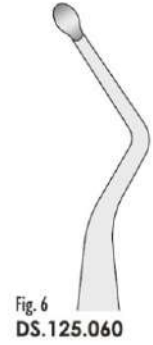
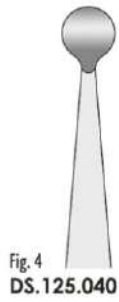
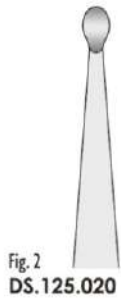
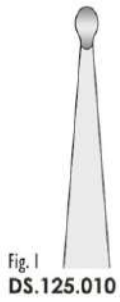

Bone files / Lime per osso

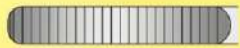

CLASSIC-LITE 8 mm hollow handle
8 mm pusty uchwył





Chisels and gouges / Scalpelli e sgorbie



Gardner



Wakefield



Fig. 1
DP.078.010

Ochenbein



Fig. 2
DP.078.020

Ochenbein



Partsch 135 mm



Partsch 135 mm

Mallets / Martelli



Stainless steel head
Con testa in acciaio inox

DS.270.190
Partsch
190 mm



Lead filled head
Con testa riempita di piombo

DS.271.190
Partsch
190 mm



FL.034.010
Spare plastic disks, pair
Coppia dischi di ricambio



FL.035.190
Mead
190 mm



FL.037.010
Spare plastic disks, pair
Coppia dischi di ricambio



FL.036.185
Falcon
185 mm

Bone cutters / Cesioie per osso



DS.503.100
Goldman-Fox
100 mm



FO.603.150
Cleveland
150 mm



Fig. 14
DS.508.140
Falcon
165 mm

Bone Rongeurs
Pinze Ossivore Alveolotome



FO.409.125
Friedmann-Mini
125 mm



FO.409.140
Friedmann
140 mm



FO.412.150
Luer
150 mm



FO.455.165
Mead
165 mm



FO.413.010



FO.413.020



Friedmann-Micro
150 mm



FO.415.150



FO.416.150



FO.417.145



Blumenthal
145 mm



FO.514.180
Bayer
180 mm



DS.514.120
Tomati
120 mm



DS.405.010
Hilger

Fits any simple stem mouth mirror handle
Adatto per qualsiasi manico per specchietto



DS.405.000
Hilger
with handle / con manico



OM.258.200
Falcon
200 mm



DS.435.010
Simplex
105 mm



30 x 19 mm
OL.219.150
Kilner
150 mm



DS.416.010
Minnesota
140 mm



DS.416.030
Cawood-Minnesota
150 mm



OM.251.120
120 mm

OM.253.140
140 mm

OM.254.150
150 mm

Sternberg



DS.389.145
Columbia
145 mm



DS.427.030
Oringer
115 mm



Fig. 2
DS.375.020
Austin

Finger protectors / Proteggi-Dito



OM.001.010
Small / Piccolo

OM.002.020
Medium / Media

OM.003.030
Large / Grande

Langenbeck

Silicone mouth props / Apribocca in silicone



OM.019.030
Large / Grande

OM.019.010
Small / Piccolo

Cheek holder / Divaricatore per guance



OM.019.000

Mouth gags / Apribocca



Molt

OM.038.100 100 mm
OM.040.110 110 mm
OM.041.140 140 mm



OM.030.130
Heister
130 mm



OM.048.160 160 mm
OM.049.190 190 mm
Roser-König

Retractors / Divaricatori



35 x 11 mm

DS.480.220
Obwegeser
Spina-nasalis retractor
Divaricatore per spina nasale
220 mm



72 x 11 mm

DS.476.220
Obwegeser
Ramus retractor for
separation of ramus & tissue
Divaricatore Ramus per tenere
lontano il tessuto molle
220 mm

Tongue depressors / Abbassalingua



OM.202.145
145 mm



OM.205.180
180 mm



OM.208.190
Bruenings
190 mm

30 mm

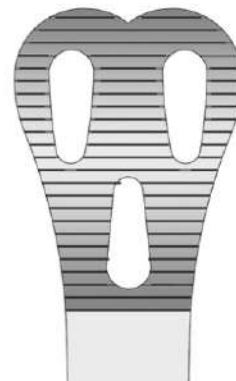

OM.236.140
140 mm

36 mm



Wieder

OM.237.150
150 mm



Scalpel blades / Lame per bisturi



Sterile
Individually packed
Box of 100 pieces

Sterile
Bustina individuale
Conf. 100 pezzi

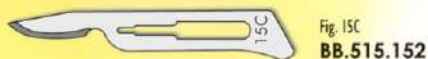
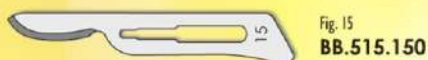
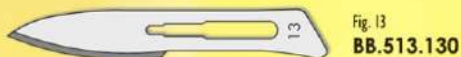
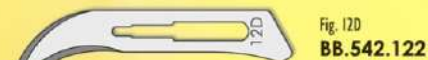
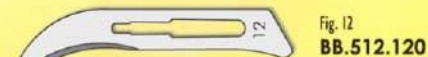

Scalpel handles / Manici per bisturi

For scalpel blades no / Per le lame no : 10, 11, 12, 12D, 13, 15, 15C



For blades no / Per le lame no : 20, 21, 22, 23, 24, 25



Scalpels / Bisturi



Disposable scalpels / Bisturi monouso



Sterile, individually packed, box of 10 pieces
 Sterile, bustina individuale, conf. 10 pezzi

Blade remover / Togliilame



BB.100.150
150 mm



Scissors with Tungsten Carbide Inserts
Forbici con Riporti al Carburo di Tungsteno

Key Features

- Extremely smooth cutting with less trauma.
- Manufactured from high quality stainless steel and tungsten carbide inserts for longer-lasting cutting edge.
- Gold plated rings.



Caratteristiche

- Taglio di precisione atraumatico.
- Realizzate con acciai di elevata qualità e riporti al carburo di tungsteno per mantenere a lungo il taglio.
- Anelli placcati d'oro.

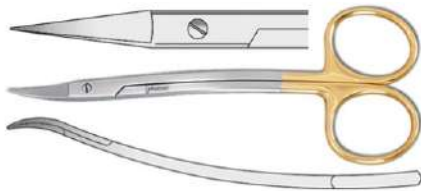

BC.155.115
La Grange
115 mm

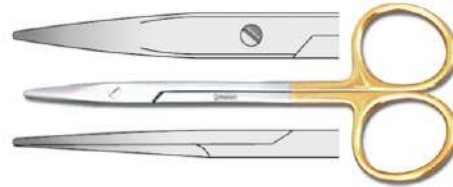

BC.256.115
Strabismus
115 mm



BC.210.115
Iris
115 mm

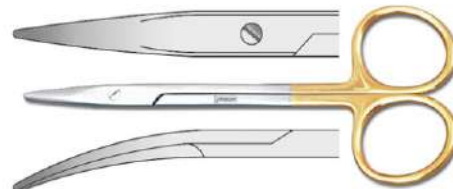

BC.257.115
Strabismus
115 mm



BC.211.115
Iris
115 mm



BC.260.145
Metzenbaum
145 mm

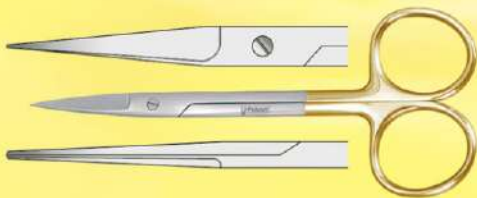

DS.596.120
Falcon
120 mm



BC.261.145
Metzenbaum
145 mm

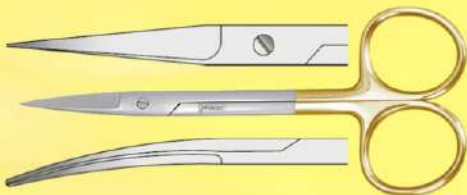

DS.597.120
Falcon
120 mm

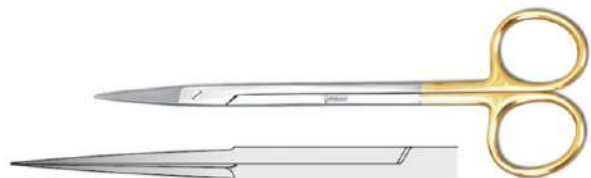

BC.158.160
Kelly
160 mm

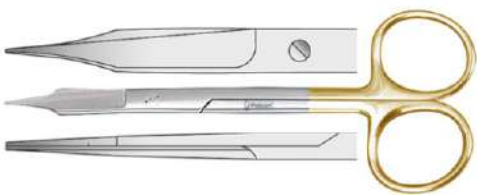

DS.600.130
Goldman-Fox
130 mm

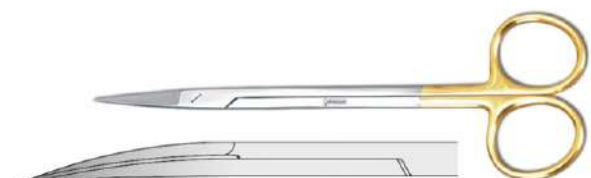

BC.159.160
Kelly
160 mm

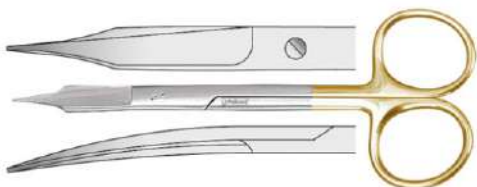

DS.601.130
Goldman-Fox
130 mm



Super-Cut

- Cutting blade horned to "razor" sharpness with opposing blade finished with fine serrations to avoid tissue slippage.
- Extremely smooth cutting with less trauma.
- Manufactured from high quality stainless steel to provide longer-lasting cutting edge.
- Single gold plated ring for easy identification.

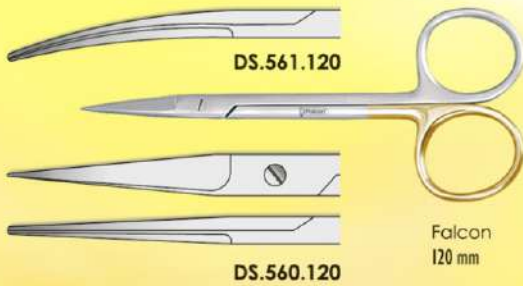

Super-Cut

- Lama di taglio con affilatura a "rasoio" con controlama finemente zigrinata per evitare scivolamenti del tessuto.
- Taglio di grande precisione e quindi atraumatico.
- Realizzate con acciai di elevata qualità per mantenere a lungo il taglio.
- Anello singolo placcato d'oro per una facile identificazione.

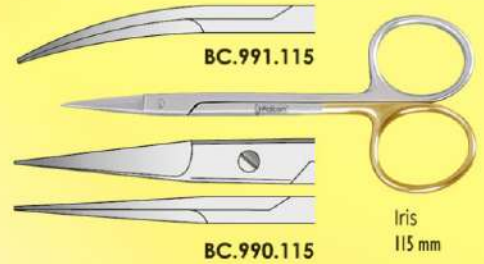

Scissors, One Blade Serrated

- One blade is with fine serrations to avoid tissue or ligature slippage.
- Manufactured from high quality stainless steel to provide longer-lasting cutting edge.
- Single black ring for easy identification.

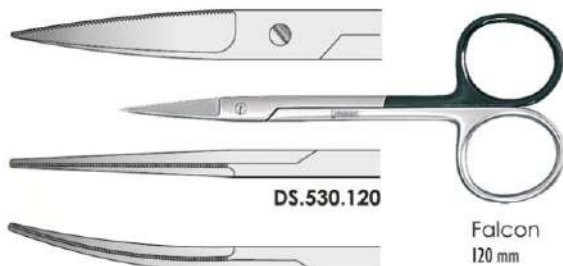

DS.531.120



DS.533.120

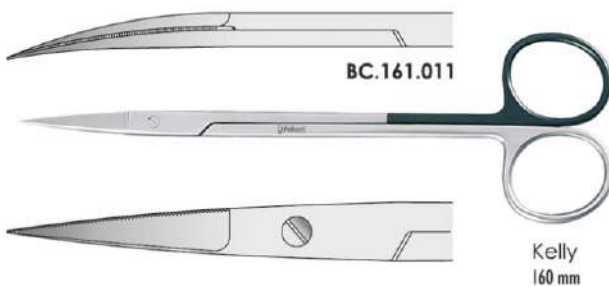

Forbici con Una Lama Zigrinata

- Una lama è rifinita con finissime zigrinature per trattenerne il tessuto o la legatura durante il taglio.
- Realizzate in acciai di elevata qualità per mantenere a lungo un taglio perfetto.
- Anello singolo nero per una facile identificazione.

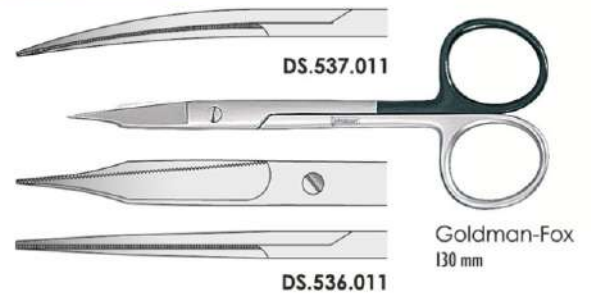

Surgery



OC.484.120



OC.483.120



OC.495.120

**Noyes /
Castroviejo**
120 mm



BC.154.115

La Grange
115 mm



BC.110.115

Iris
115 mm



BC.111.115



BC.116.115



BC.117.115



DS.524.120

Falcon
120 mm



DS.525.120



DS.526.120



DS.527.120

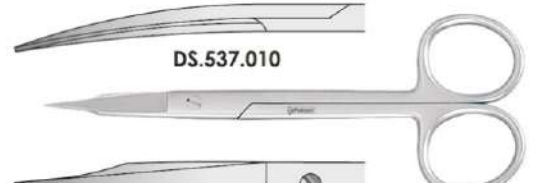

DS.537.010

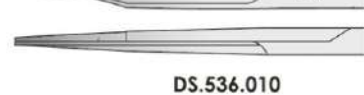

DS.536.010

Goldman-Fox
130 mm



DS.539.010

Goldman-Fox
130 mm

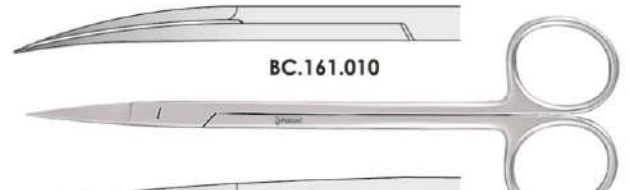

BC.161.010



BC.160.010

Kelly
160 mm

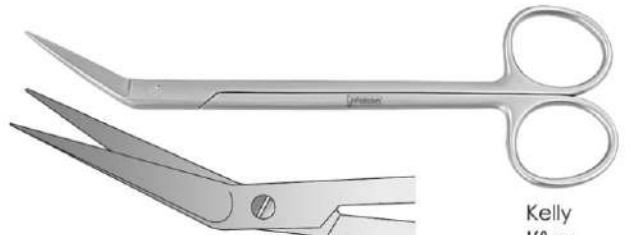

BC.162.010

Kelly
160 mm

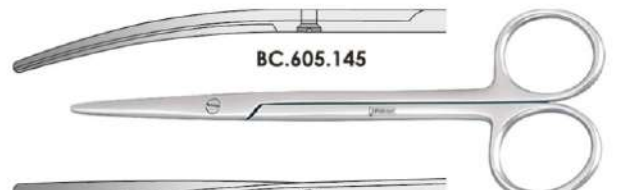

BC.605.145



BC.601.145

Metzenbaum
145 mm



Operating scissors / Forbici per chirurgia

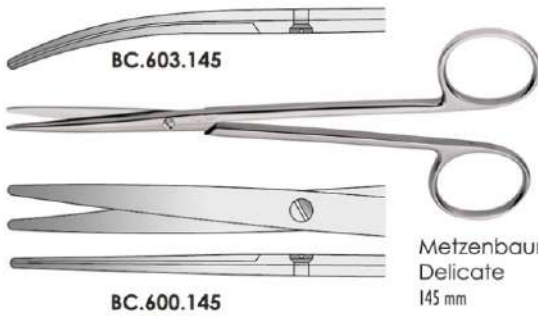

Metzenbaum-
Delicate
145 mm

Operating scissors / Forbici per chirurgia

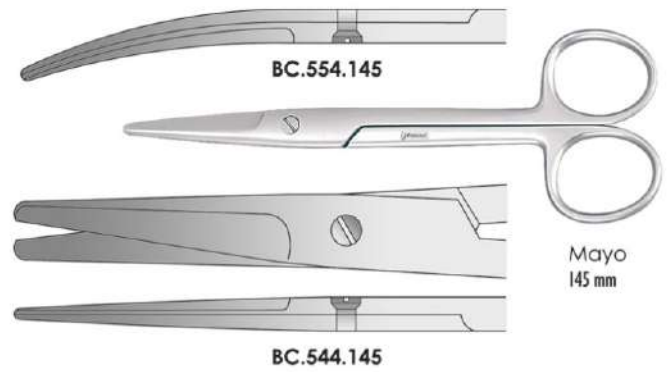

Mayo
145 mm

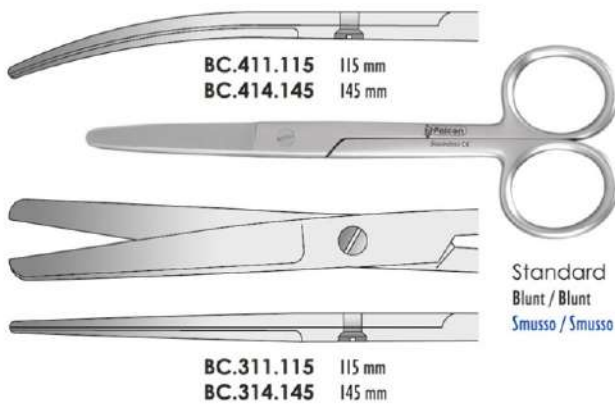

Standard
Blunt / Blunt
Smusso / Smusso

Suture scissors / Forbici per legature

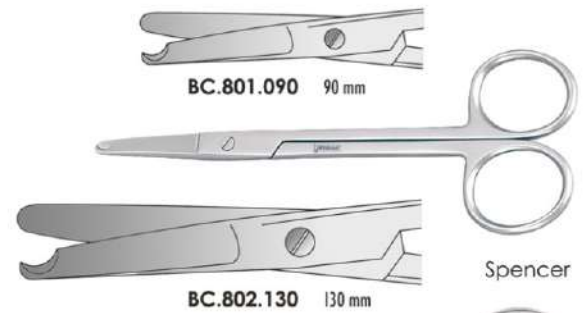

Spencer

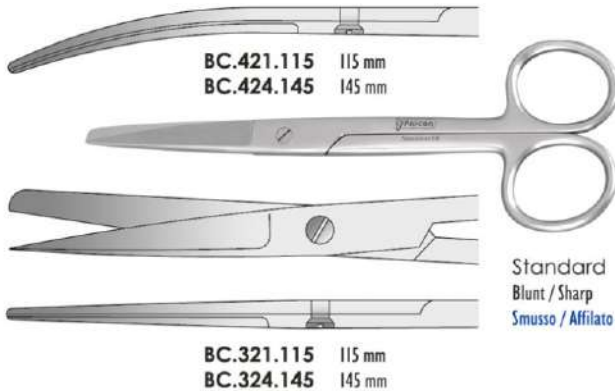

Standard
Blunt / Sharp
Smusso / Affilato



Littauer

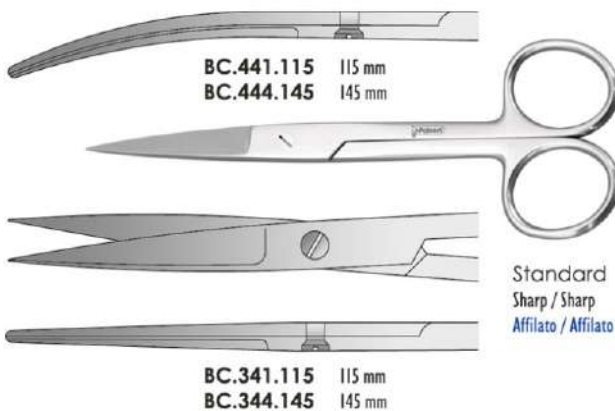

Standard
Sharp / Sharp
Affilato / Affilato

Bandage scissors / Forbici per bendaggi



Lister



BC.881.180 180 mm Universal

Dissecting and Tissue Forceps
Pinzette Anatomiche e Chirurgiche



Titanium
Titanio

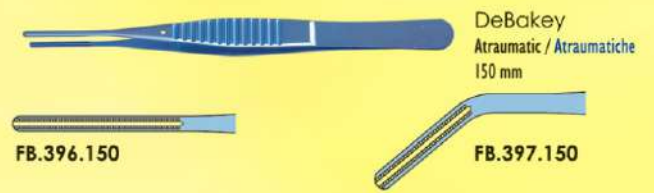

Falcon
GRIP
With tungsten carbide inserts
Con inserti al carburo di tungsteno

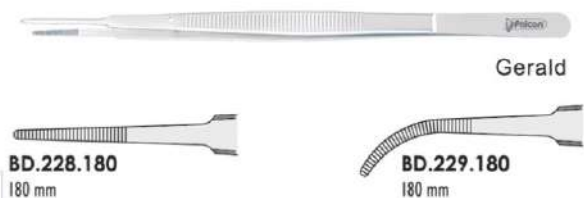
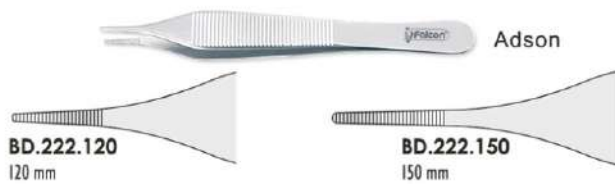



Dissecting forceps / Pinzette anatomiche



Standard



BD.043.100 100 mm



BD.049.160 160 mm



BD.043.115 115 mm



BD.050.180 180 mm



BD.045.130 130 mm



BD.051.200 200 mm



BD.047.145 145 mm



BD.052.250 250 mm



BD.048.150 150 mm



BD.053.300 300 mm

Tissue forceps / Pinzette chirurgiche

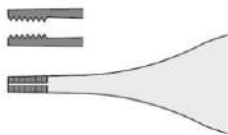

BD.700.120
Adson-Brown
120 mm



Standard

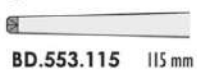

BD.553.115 115 mm



BD.559.160 160 mm

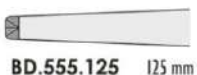

BD.555.125 125 mm



BD.560.180 180 mm



BD.557.145 145 mm



BD.561.200 200 mm

Micro forceps / Micro pinzette



Fig. 2
BD.328.020
110 mm



Fig. 3
BD.328.030
110 mm



Fig. 4
BD.328.040
110 mm



Fig. 5
BD.328.050
110 mm



Fig. 5A
BD.328.055
110 mm



Fig. 7
BD.328.070
110 mm

Splinter forceps / Pinze per frammenti



Stieglitz



BD.992.140
140 mm



BD.993.135
135 mm



BD.994.125
125 mm

Towel forceps / Pinze per pannilino



BF.411.090
 Schaedel
 90 mm



BF.407.090
 Jones
 90 mm



Backhaus
BF.431.090
 90 mm

BF.432.110
 110 mm

BF.433.130
 130 mm

Dressing and sponge forceps / Pinze porta tamponi e spugne

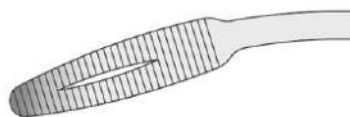

BF.047.200 200 mm
BF.047.250 250 mm



Gross-Maier



BF.046.200 200 mm
BF.046.250 250 mm

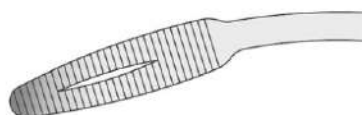

BF.057.200 200 mm
BF.057.250 250 mm

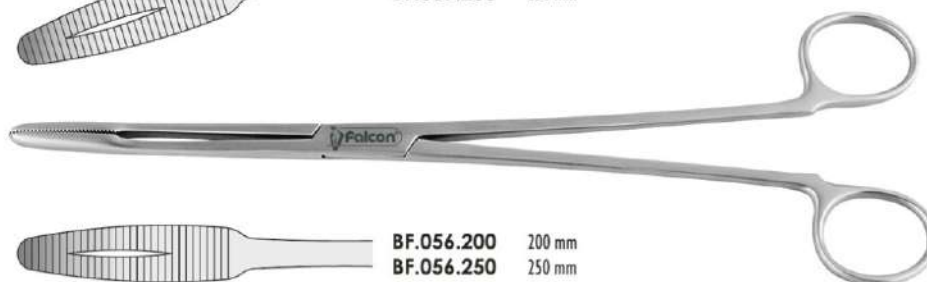

Gross-Maier



BF.056.200 200 mm
BF.056.250 250 mm

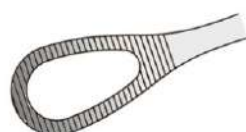

BF.123.250 250 mm



Forester



BF.122.250 250 mm

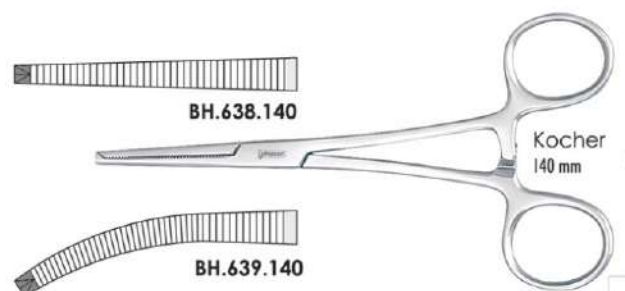
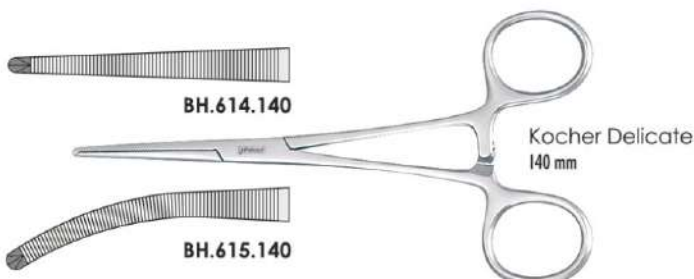
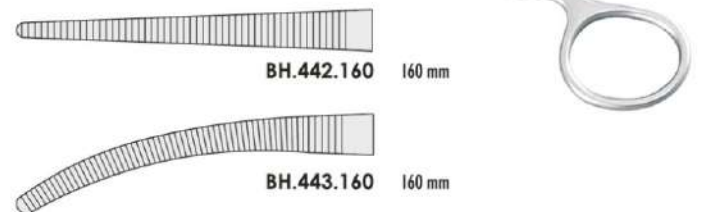
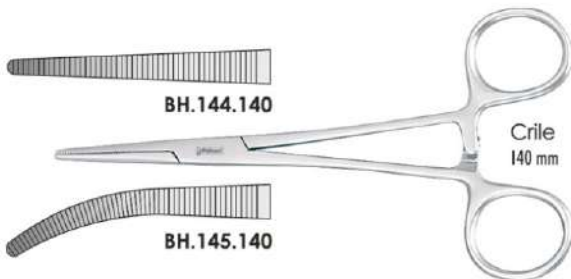
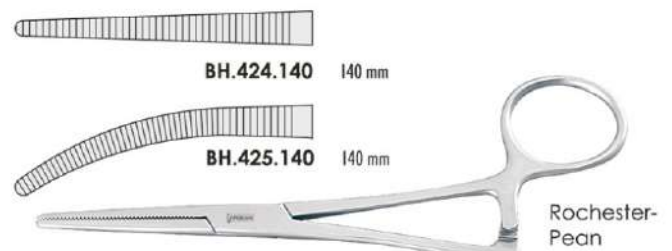
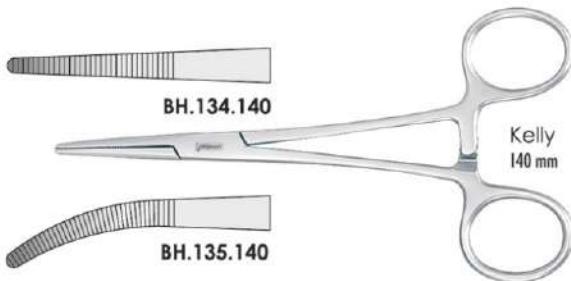
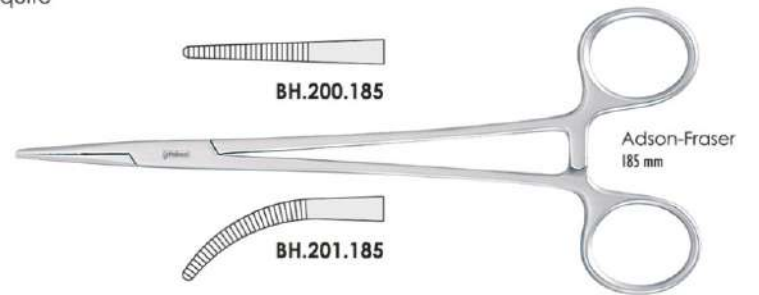
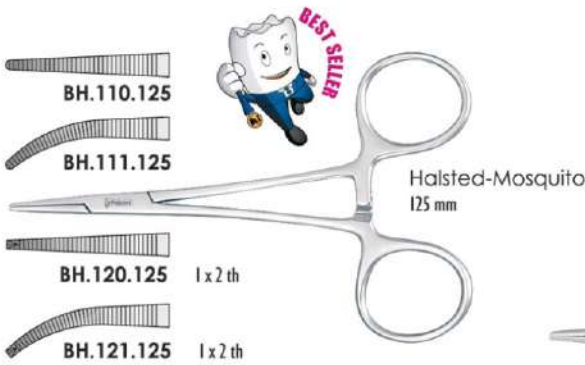
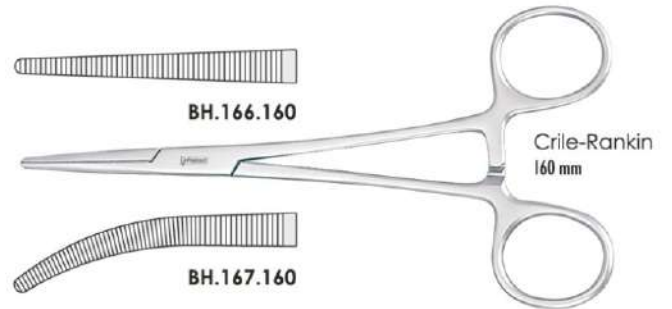
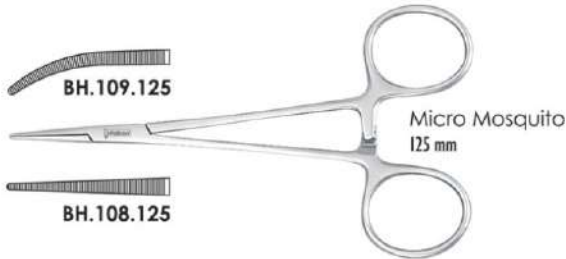
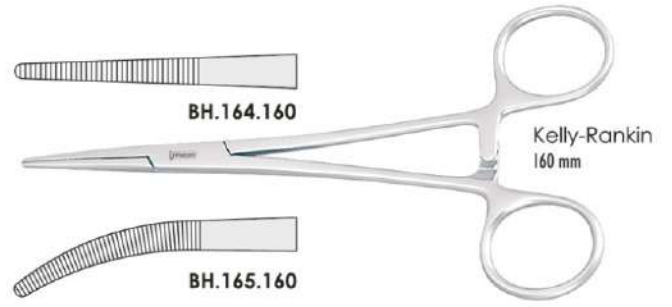

Needle Holders with Tungsten Carbide Inserts Porta Aghi con Riporti al Carburo di Tungsteno



Tungsten Carbide inserts are available in smooth or choice of 3 different serration pitches, for use with different size of suture needles as shown in chart below.

Con inserti in Carburo di Tungsteno e sono disponibili sia nella versione 'smooth' (punte lisce) che nella versione con punte zigrinate con 3 diversi passi a scelta per consentire l'uso di diversi aghi per sutura secondo la tabella che segue.

	Serration Pitch Passo zigrinatura	Suture Size Diam. sutura
	Smooth	9/0 to / fino a 11/0
	0.2 Micro	6/0 to / fino a 10/0
	0.4 Fine	4/0 to / fino a 6/0
	0.5 Standard	Up to / fino a 3/0



Falcon Grip needle holders offer secure grip thus safe guiding of needle.

I porta Aghi Falcon-Grip consentono un'ottima tenuta ed un sicuro controllo dell'ago.



0.2
BM.002.030

0.2
BM.002.010



Castroviejo
140 mm

BM.002.040

BM.002.020



Castroviejo
140 mm

BM.002.080

BM.002.070



Castroviejo
140 mm

0.2



BM.002.050
Castroviejo
140 mm

0.2



BM.002.060
Castroviejo
140 mm

0.2



BM.002.090
Castroviejo
140 mm

0.2



BM.004.010
Castroviejo
180 mm





Needle Holders with Tungsten Carbide Inserts
Porta Aghi con Riporti al Carburo di Tungsteno

Falcon[®] with tungsten carbide inserts
GRIP con inserti al carburo di tungsteno

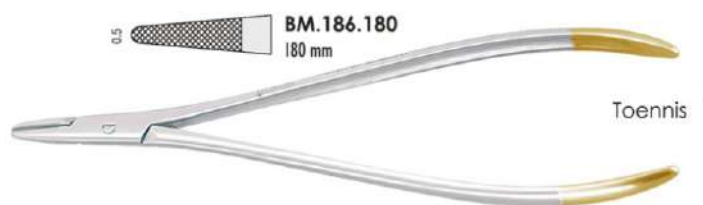
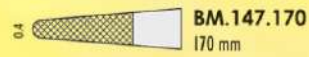
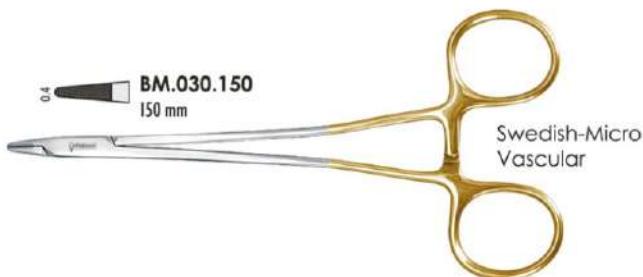
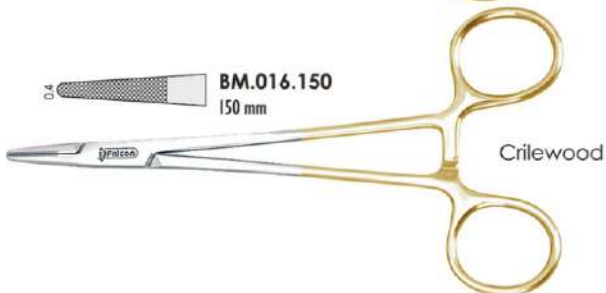

Surgery

Needle Holders
Porta Aghi

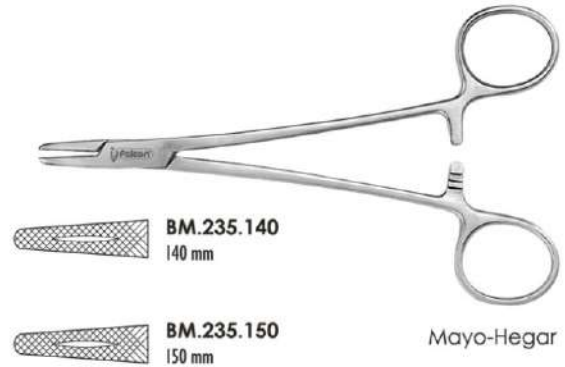
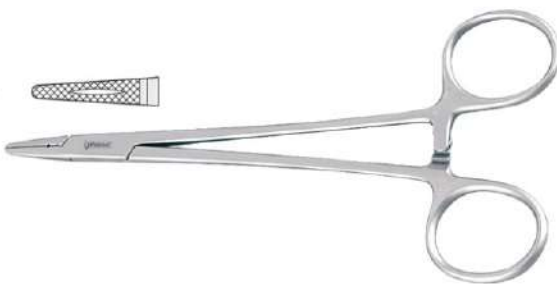
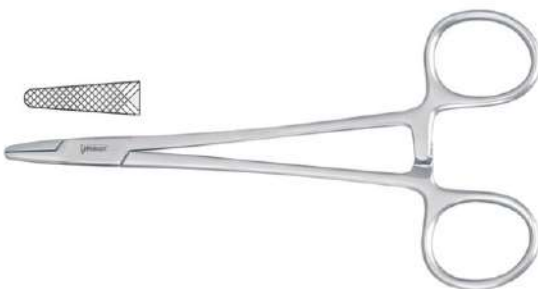
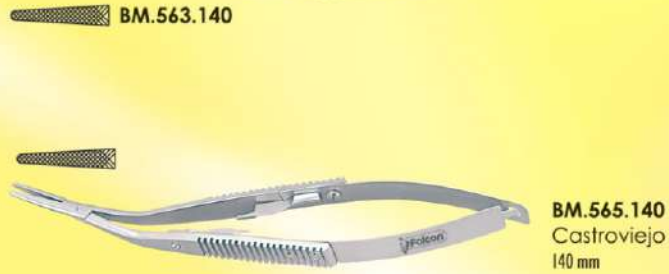



Needle cases / Recipienti per aghi



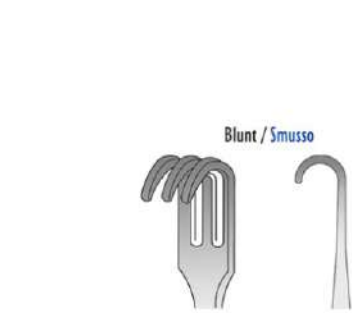

Blunt / Smusso

BT.005.160



Senn-Miller
160 mm



Sharp / Affilato

BT.008.160



Sharp / Affilato

BT.111.010



BT.112.020



BT.113.030



BT.114.040



Falcon
160 mm



Blunt / Smusso

BT.116.010



BT.117.020



BT.118.030



Falcon
160 mm

BT.119.040

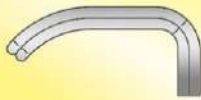

Farabeuf
BT.020.120
120 mm
Pair / Paio

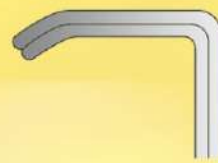

Parker-Langenbeck
BT.041.210
210 mm
Pair / Paio



Kocher
215 mm



BT.361.010
55 x 11 mm

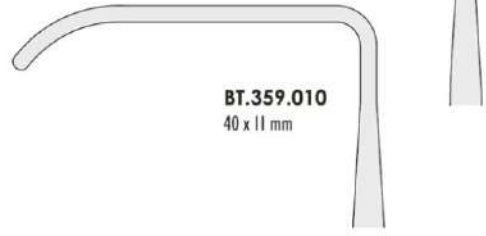

BT.359.010
40 x 11 mm

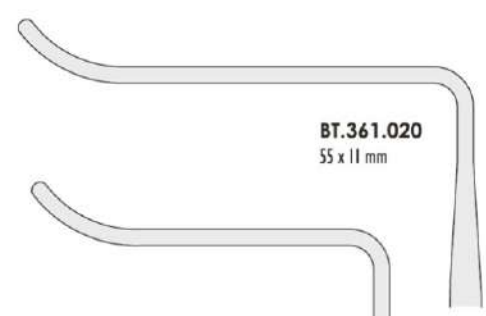

BT.361.020
55 x 11 mm



BT.359.020
40 x 11 mm



Middeldorph

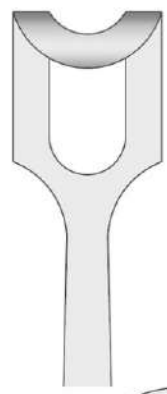

BT.405.220
20 x 22 mm
220 mm

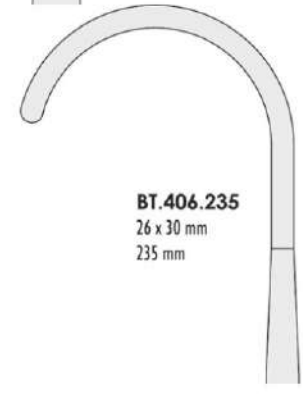

BT.406.235
26 x 30 mm
235 mm

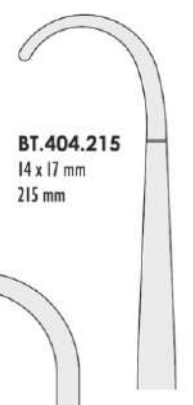

BT.404.215
14 x 17 mm
215 mm



■ **Langenbeck**
220 mm



■ **Langenbeck**
220 mm

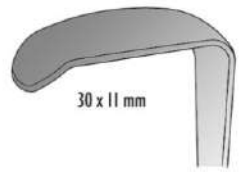

30 x 11 mm

■ **BT.320.020**
■ **BT.311.020**

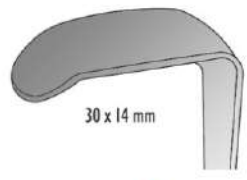

30 x 14 mm

■ **BT.321.020**
■ **BT.312.020**



30 x 16 mm

■ **BT.323.020**
■ **BT.313.020**

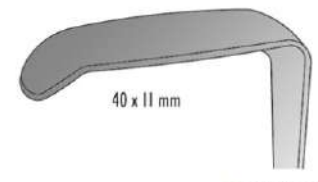

40 x 11 mm

■ **BT.325.020**
■ **BT.315.020**

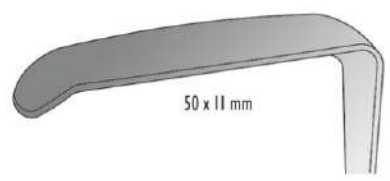

50 x 11 mm

■ **BT.326.020**
■ **BT.316.020**

Skin hooks / Uncini cutanei



Kilner

OL.610.150 150 mm



Gillies

OL.611.180 180 mm

OL.612.180 180 mm

Probes / Sonde

Ø 1.0 mm **BN.104.145**
145 mm

Ø 2.0 mm **BN.134.145**
145 mm

Self-Retaining retractors / Divaricatori autostatici



Alm
70 mm

BV.010.070 Sharp / Affilato
BV.010.071 Blunt / Smusso



BV.071.130 Sharp / Affilato
BV.074.130 Blunt / Smusso

Weitlaner
130 mm

Suture forceps / Pinzetta per sutura



DS.650.160
160 mm

Suction tubes
Cannule per aspirazione chirurgica

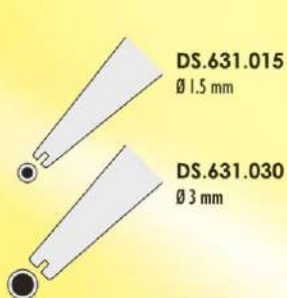

DS.631.015
Ø 1.5 mm

DS.631.030
Ø 3 mm

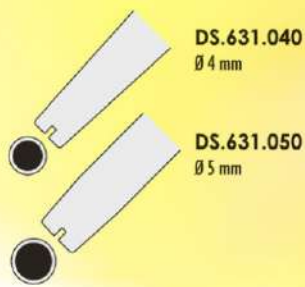

DS.631.040
Ø 4 mm

DS.631.050
Ø 5 mm

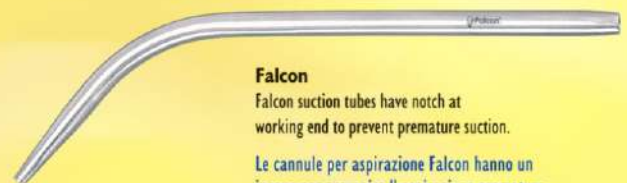

Falcon

Falcon suction tubes have notch at working end to prevent premature suction.

Le cannule per aspirazione Falcon hanno un incavo per prevenire l'aspirazione prematura.



Frazier

GF.920.010 6FG / 2 mm
GF.920.020 8FG / 2.6 mm
GF.920.030 10FG / 3.3 mm
GF.920.040 12FG / 4 mm



DS.635.010 Small / Piccolo
DS.635.020 Large / Grande
Ladmore

Impression / Porta Impronte





all for 1 – 1 for all

DI.1150.00

Universal dispenser kit for all ratios of 50ml cartridges

Contents:

- 1 x Dispenser
- 1 x Cartridge holder for rectangular flange cartridges (old type)
- 1 x Cartridge holder for round flange cartridges (new type)
- 1 x Plunger for 1:1/2:1 ratio
- 1 x Plunger for 4:1 ratio
- 1 x Plunger for 10:1 ratio

Kit pistola dispenser universale per qualsiasi cartuccia da 50 ml.

Contenente:

- 1 x pistola dispenser
- 1 x porta cartucce con flange rettangolari (vecchio tipo)
- 1 x porta cartucce con flange rotonde (nuovo tipo)
- 1 x stantuffo adatto a 1:1/2:1
- 1 x stantuffo adatto a 4:1
- 1 x stantuffo adatto a 10:1





Bite gauge / Calibro facciale

A simple measuring instrument as an aid in the re-establishment of correct facial contour during full or partial denture work.

Un semplice strumento di misura che aiuta a ripristinare il corretto assetto facciale nella esecuzione di protesi parziali o totali.



Slide B is fully adjustable and reversible along shaft A and may be fixed in any position by means of its locking-screw as shown.

il cursore B può essere aggiustato e invertito rispetto all'asse A e quindi fissato in posizione mediante una vite di bloccaggio come illustrato di seguito.

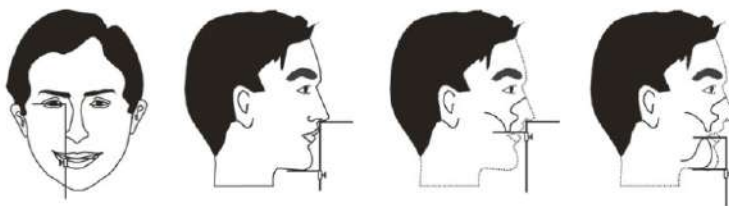

**Bite plane
Piano di occlusione**



DI.002.000
Fox

Carvers for silicone impression materials / Strumento per modellare impronte in silicone



DI.010.017



DI.010.014

Gingival cord packers / Strumenti per filo retrattore



DI.005.010 Serrated / Zigrinato

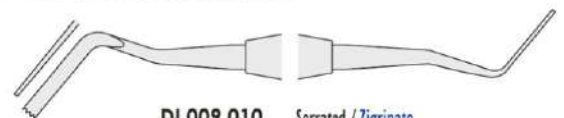

DI.009.010 Serrated / Zigrinato

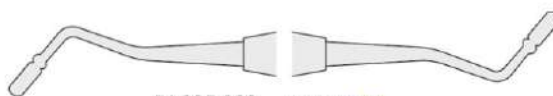

DI.005.020 Smooth / Liscio

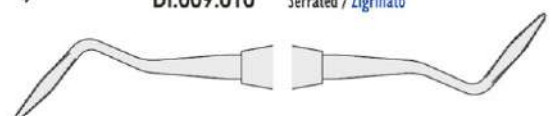

DI.006.020 Serrated / Zigrinato



DI.005.014 Serrated / Zigrinato



DI.005.024 Smooth / Liscio

Disposable Impression Trays

Porta Impronte Monouso

DENTALINE

Disposable impression trays, available in green or blue colors
Porta impronte monouso disponibili in verde o blu

Made

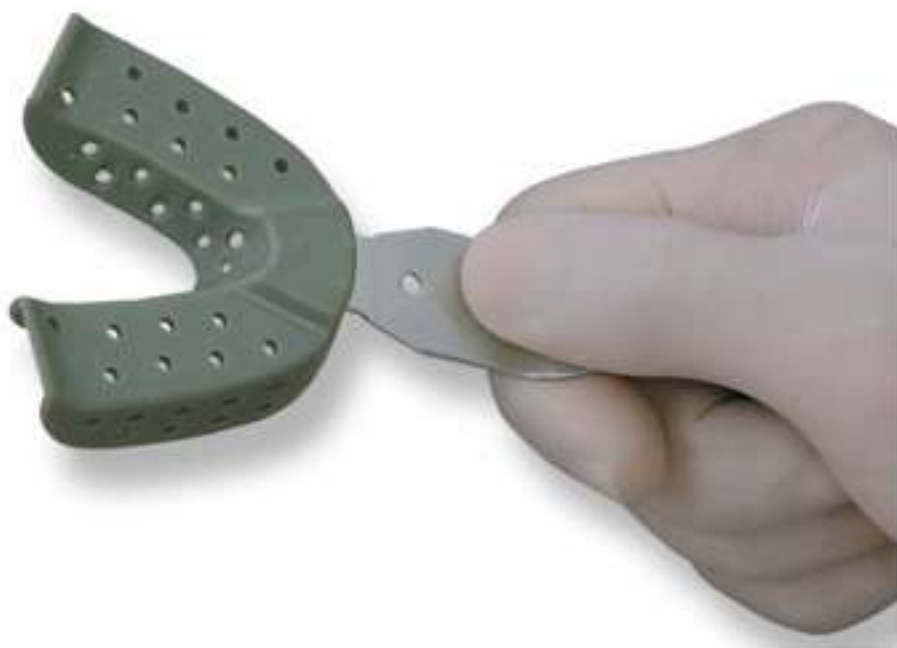

Pack includes 25 trays of I size and I handle
Confezione comprende 25 P.I. per misura e I manico

Trial pack / Confezione prova

● DI.025.000

● DI.026.000

25 assorted trays and I handle

25 P. Impronte assortite + I manico

D-Color

Impression Trays / Porta Impronte

- Color Coded for easy identification of size
- Micro etched inner surface for better retention
- Available perforated or solid
- Identificazione della misura attraverso il colore
- Superfici interne microruvide per maggiore ritenzione
- In allestimento perforato o liscio.



Impression trays regular / Porta impronte tipo regular

Perforated with rim Perforate con bordo ritentivo

Lower / Inferiori



L1 / XL
DI.801.010
Purple / Porpora



L2 / L
DI.801.020
Green / Verde



L3 / M
DI.801.030
Blue / Blu



L4 / S
DI.801.040
Red / Rosso



L5 / XS
DI.801.050
Yellow / Gialla



DI.851.060
Set of 6 pieces / Serie di 6 pezzi

Upper / Superiori



U1 / XL
DI.811.010
Purple / Porpora



U2 / L
DI.811.020
Green / Verde



U3 / M
DI.811.030
Blue / Blu



U4 / S
DI.811.040
Red / Rosso



U5 / XS
DI.811.050
Yellow / Gialla



DI.851.000
Set of 10 pieces / Serie di 10 pezzi

Solid with rim Lisce con bordo ritentivo

Lower / Inferiori



L1 / XL
DI.821.010
Purple / Porpora



L2 / L
DI.821.020
Green / Verde



L3 / M
DI.821.030
Blue / Blu



L4 / S
DI.821.040
Red / Rosso



L5 / XS
DI.821.050
Yellow / Gialla



DI.861.060
Set of 6 pieces / Serie di 6 pezzi

Upper / Superiori



U1 / XL
DI.831.010
Purple / Porpora



U2 / L
DI.831.020
Green / Verde



U3 / M
DI.831.030
Blue / Blu



U4 / S
DI.831.040
Red / Rosso



U5 / XS
DI.831.050
Yellow / Gialla



DI.861.000
Set of 10 pieces / Serie di 10 pezzi



Made of high quality non-magnetic stainless steel (AISI304).
Micro etched inner surface for better retention.

Prodotte con acciaio inox antimagnetico (AISI 304) di elevata qualità
Superfici interne microruvide per maggiore ritenzione.



Impression trays regular / Porta impronte tipo regular

Perforated without rim
Perforate senza bordo ritentivo

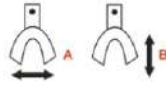

No.	Size	A mm	B mm	Code / Codice
L1	XXS	55	47	DI.700.010
L2	XS	60	49	DI.700.020
L3	S	72	54	DI.700.030
L4	M	74	57	DI.700.040
L5	L	76	59	DI.700.050
L6	XL	78	61	DI.700.060

Perforated with rim
Perforate con bordo ritentivo

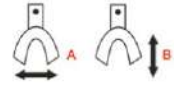

No.	Size	A mm	B mm	Code / Codice
L1	XXS	55	47	DI.750.010
L2	XS	60	49	DI.750.020
L3	S	72	54	DI.750.030
L4	M	74	57	DI.750.040
L5	L	76	59	DI.750.050
L6	XL	78	61	DI.750.060



No.	Size	A mm	B mm	Code / Codice
U1	XXS	61	47	DI.705.010
U2	XS	64	51	DI.705.020
U3	S	66	53	DI.705.030
U4	M	69	57	DI.705.040
U5	L	71	60	DI.705.050
U6	XL	73	62	DI.705.060



No.	Size	A mm	B mm	Code / Codice
U1	XXS	61	47	DI.755.010
U2	XS	64	51	DI.755.020
U3	S	66	53	DI.755.030
U4	M	69	57	DI.755.040
U5	L	71	60	DI.755.050
U6	XL	73	62	DI.755.060



Set	Contents / Contenuto	Code / Codice
6 pieces/pezzi	L3,L4,L5,U3,U4,U5	DI.720.060
8 pieces/pezzi	L3,L4,L5,L6,U3,U4,U5,U6	DI.720.080
12 pieces/pezzi	L1,L2,L3,L4,L5,L6 U1,U2,U3,U4,U5,U6	DI.720.000



Set	Contents / Contenuto	Code / Codice
6 pieces/pezzi	L3,L4,L5,U3,U4,U5	DI.770.060
8 pieces/pezzi	L3,L4,L5,L6,U3,U4,U5,U6	DI.770.080
12 pieces/pezzi	L1,L2,L3,L4,L5,L6 U1,U2,U3,U4,U5,U6	DI.770.000

Solid without rim
Lisce senza bordo ritentivo

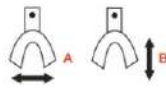

No.	Size	A mm	B mm	Code / Codice
L1	XXS	55	47	DI.710.010
L2	XS	60	49	DI.710.020
L3	S	72	54	DI.710.030
L4	M	74	57	DI.710.040
L5	L	76	59	DI.710.050
L6	XL	78	61	DI.710.060

Solid with rim
Lisce con bordo ritentivo

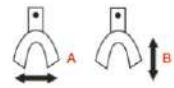

No.	Size	A mm	B mm	Code / Codice
L1	XXS	55	47	DI.760.010
L2	XS	60	49	DI.760.020
L3	S	72	54	DI.760.030
L4	M	74	57	DI.760.040
L5	L	76	59	DI.760.050
L6	XL	78	61	DI.760.060

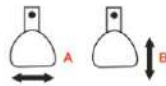

No.	Size	A mm	B mm	Code / Codice
U1	XXS	61	47	DI.715.010
U2	XS	64	51	DI.715.020
U3	S	66	53	DI.715.030
U4	M	69	57	DI.715.040
U5	L	71	60	DI.715.050
U6	XL	73	62	DI.715.060



No.	Size	A mm	B mm	Code / Codice
U1	XXS	61	47	DI.765.010
U2	XS	64	51	DI.765.020
U3	S	66	53	DI.765.030
U4	M	69	57	DI.765.040
U5	L	71	60	DI.765.050
U6	XL	73	62	DI.765.060



Set	Contents / Contenuto	Code / Codice
6 pieces/pezzi	L3,L4,L5,U3,U4,U5	DI.725.060
8 pieces/pezzi	L3,L4,L5,L6,U3,U4,U5,U6	DI.725.080
12 pieces/pezzi	L1,L2,L3,L4,L5,L6 U1,U2,U3,U4,U5,U6	DI.725.000



Set	Contents / Contenuto	Code / Codice
6 pieces/pezzi	L3,L4,L5,U3,U4,U5	DI.780.060
8 pieces/pezzi	L3,L4,L5,L6,U3,U4,U5,U6	DI.780.080
12 pieces/pezzi	L1,L2,L3,L4,L5,L6 U1,U2,U3,U4,U5,U6	DI.780.000



Made of high quality non-magnetic stainless steel (AISI304).
Micro etched inner surface for better retention.

Prodotte con acciaio inox antimagnetico (AISI 304) di elevata qualità
Superfici interne microruvide per maggiore ritenzione.



Impression trays regular / Porta impronte tipo regular

Perforated with rim
Perforate con bordo ritentivo



Lower / Inferiori

No.	Size	A mm	B mm	Code / Codice
L1	XL	80	63	DI.800.010
L2	L	78	59	DI.800.020
L3	M	76	57	DI.800.030
L4	NM	72	57	DI.800.040
L5	S	69	50	DI.800.050



Upper / Superiori

No.	Size	A mm	B mm	Code / Codice
U1	XL	81	63	DI.810.010
U2	L	74	60	DI.810.020
U3	M	71	55	DI.810.030
U4	NM	67	53	DI.810.040
U5	S	65	51	DI.810.050



Set	Contents / Contenuto	Code / Codice
6 pieces/pezzi	L2,L3,L4,U2,U3,U4	DI.850.060
10 pieces/pezzi	L1,L2,L3,L4,L5 U1,U2,U3,U4,U5	DI.850.000

Solid with rim
Lisce con bordo ritentivo



Lower / Inferiori

No.	Size	A mm	B mm	Code / Codice
L1	XL	80	63	DI.820.010
L2	L	78	59	DI.820.020
L3	M	76	57	DI.820.030
L4	NM	72	57	DI.820.040
L5	S	69	50	DI.820.050



Upper / Superiori

No.	Size	A mm	B mm	Code / Codice
U1	XL	81	63	DI.830.010
U2	L	74	60	DI.830.020
U3	M	71	55	DI.830.030
U4	NM	67	53	DI.830.040
U5	S	65	51	DI.830.050



Set	Contents / Contenuto	Code / Codice
6 pieces/pezzi	L2,L3,L4,U2,U3,U4	DI.860.060
10 pieces/pezzi	L1,L2,L3,L4,L5 U1,U2,U3,U4,U5	DI.860.000

Impression trays for children / Porta impronte per bambini

Perforated with rim
Perforate con bordo ritentivo



Lower / Inferiori

No.	Size	A mm	B mm	Code / Codice
L1	S	54	47	DI.200.010
L2	M	62	51	DI.200.020
L3	L	70	55	DI.200.030



Upper / Superiori

No.	Size	A mm	B mm	Code / Codice
U1	S	55	43	DI.210.010
U2	M	60	45	DI.210.020
U3	L	63	49	DI.210.030



Set	Contents / Contenuto	Code / Codice
6 pieces/pezzi	L1,L2,L3,U1,U2,U3	DI.250.000

Solid with rim
Lisce con bordo ritentivo



Lower / Inferiori

No.	Size	A mm	B mm	Code / Codice
L1	S	54	47	DI.220.010
L2	M	62	51	DI.220.020
L3	L	70	55	DI.220.030



Upper / Superiori

No.	Size	A mm	B mm	Code / Codice
U1	S	55	43	DI.230.010
U2	M	60	45	DI.230.020
U3	L	63	49	DI.230.030



Set	Contents / Contenuto	Code / Codice
6 pieces/pezzi	L1,L2,L3,U1,U2,U3	DI.260.000

Impression trays regular Ehrlicke pattern perforated / Porta impronte tipo regular mod. Ehrlicke

Lower / Inferiori



No.	Size	A mm	B mm	Code / Codice
UB0	XS	65	46	DI.600.000
UB1	S	67	50	DI.600.010
UB2	M	76	54	DI.600.020
UB3	L	79	56	DI.600.030
UB4	XL	79	61	DI.600.040



DI.640.000
Set of 10 pieces / Serie di 10 pezzi
Contents / Contenuto
UB0,UB1,UB2,UB3,UB4
OB0,OB1,OB2,OB3,OB4

Upper / Superiori



No.	Size	A mm	B mm	Code / Codice
OB0	XS	59	52	DI.610.000
OB1	S	66	52	DI.610.010
OB2	M	71	62	DI.610.020
OB3	L	71	64	DI.610.030
OB4	XL	80	70	DI.610.040



Made of high quality non-magnetic stainless steel (AISI304).
Micro etched inner surface for better retention.

Prodotte con acciaio inox antimagnetico (AISI 304) di elevata qualità
Superfici interne microruvide per maggiore ritenzione.



Impression trays edentulous / Porta impronte edentule

Perforated with rim
Perforate con bordo ritentivo

Lower / Inferiori

No.	Size	A mm	B mm	Code / Codice
L1	XL	84	65	DI.300.010
L2	L	77	64	DI.300.020
L3	M	76	60	DI.300.030
L4	S	68	57	DI.300.040

Upper / Superiori

No.	Size	A mm	B mm	Code / Codice
U1	XL	80	62	DI.310.010
U2	L	77	60	DI.310.020
U3	M	70	60	DI.310.030
U4	S	72	56	DI.310.040

Set
8 pieces/pezzi Contents / Contenuto L1, L2, L3, L4, U1, U2, U3, U4 Code / Codice DI.350.000

Solid with rim
Lisce con bordo ritentivo

Lower / Inferiori

No.	Size	A mm	B mm	Code / Codice
L1	XL	84	65	DI.320.010
L2	L	77	64	DI.320.020
L3	M	76	60	DI.320.030
L4	S	68	57	DI.320.040

Upper / Superiori

No.	Size	A mm	B mm	Code / Codice
U1	XL	80	62	DI.330.010
U2	L	77	60	DI.330.020
U3	M	70	60	DI.330.030
U4	S	72	56	DI.330.040

Set
8 pieces/pezzi Contents / Contenuto L1, L2, L3, L4, U1, U2, U3, U4 Code / Codice DI.360.000

Impression trays anterior depressed / Porta impronte depresse anteriormente

Perforated with rim
Perforate con bordo ritentivo

Lower / Inferiori

No.	Size	A mm	B mm	Code / Codice
L1	S	65	48	DI.500.010
L2	M	72	57	DI.500.020
L3	L	75	57	DI.500.030

Upper / Superiori

No.	Size	A mm	B mm	Code / Codice
U1	S	64	56	DI.510.010
U2	M	67	60	DI.510.020
U3	L	72	63	DI.510.030

Set
6 pieces/pezzi Contents / Contenuto L1, L2, L3, U1, U2, U3 Code / Codice DI.550.000

Solid with rim
Lisce con bordo ritentivo

Lower / Inferiori

No.	Size	A mm	B mm	Code / Codice
L1	S	65	48	DI.520.010
L2	M	72	57	DI.520.020
L3	L	75	57	DI.520.030

Upper / Superiori

No.	Size	A mm	B mm	Code / Codice
U1	S	64	56	DI.530.010
U2	M	67	60	DI.530.020
U3	L	72	63	DI.530.030

Set
6 pieces/pezzi Contents / Contenuto L1, L2, L3, U1, U2, U3 Code / Codice DI.560.000

Impression trays edentulous Ehricke pattern perforated / Porta impronte Edentule perforate mod. Ehricke

Lower / Inferiori

No.	Size	A mm	B mm	Code / Codice
UU1	S	70	48	DI.400.010
UU2	M	70	53	DI.400.020
UU3	L	72	57	DI.400.030

DI.450.000
Set of 6 pieces / Serie di 6 pezzi
Contents / Contenuto
UU1, UU2, UU3, OU1, OU2, OU3

Upper / Superiori

No.	Size	A mm	B mm	Code / Codice
OU1	S	64	46	DI.410.010
OU2	M	68	53	DI.410.020
OU3	L	79	61	DI.410.030



Made of high quality non-magnetic stainless steel (AISI304).
Micro etched inner surface for better retention.

Prodotte con acciaio inox antimagnetico (AISI 304) di elevata qualità
Superfici interne microruvide per maggiore ritenzione.



Perforated with rim / Perforate con bordo ritentivo



Fig. 30
DI.900.300
Upper left / Lower right
Superiore sinistra / Inferiore destra



Fig. 31
DI.900.310
Lower left / Upper right
Inferiore sinistra / Superiore destra



Fig. 32
DI.900.320
Lower jaw
Inferiore



Fig. 33
DI.900.330
Upper jaw
Superiore



Fig. 99
DI.900.990
Lateral
Laterale

Solid with rim / Lisce con bordo ritentivo



Fig. 30
DI.905.300
Upper left / Lower right
Superiore sinistra / Inferiore destra



Fig. 31
DI.905.310
Lower left / Upper right
Inferiore sinistra / Superiore destra



Fig. 32
DI.905.320
Lower jaw
Inferiore



Fig. 33
DI.905.330
Upper jaw
Superiore



Fig. 99
DI.905.990
Lateral
Laterale

Perforated without rim / Perforate senza bordo ritentivo



Lower left / Upper right
Inferiore sinistra / Superiore destra

No.	Size	Code / Codice
Fig. L2D	S	DI.899.040
Fig. L4D	M	DI.899.050
Fig. L6D	L	DI.899.060



Upper left / Lower right
Superiore sinistra / Inferiore destra

No.	Size	Code / Codice
Fig. L2S	S	DI.899.010
Fig. L4S	M	DI.899.020
Fig. L6S	L	DI.899.030

Perforated with rim / Perforate con bordo ritentivo



Lower left / Upper right
Inferiore sinistra / Superiore destra

No.	Size	Code / Codice
Fig. L2D	S	DI.901.040
Fig. L4D	M	DI.901.050
Fig. L6D	L	DI.901.060



Upper left / Lower right
Superiore sinistra / Inferiore destra

No.	Size	Code / Codice
Fig. L2S	S	DI.901.010
Fig. L4S	M	DI.901.020
Fig. L6S	L	DI.901.030

Aluminum impression trays regular perforated
Porta impronte perforate in alluminio tipo regular



Lower / Inferiori

No.	Size	A mm	B mm	Code / Codice
L0	XXS	63	44	DI.950.010
L1	XS	69	47	DI.950.020
L2	S	72	48	DI.950.030
L3	M	74	50	DI.950.040
L4	L	75	53	DI.950.050
L5	XL	83	58	DI.950.060

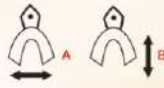

Aluminum partial impression trays for crown & bridge work
Porta impronte in alluminio parziale per ponti e corone

Lower left / Upper right
Inferiore sinistra / Superiore destra



No.	Size	Code / Codice
Fig. 1	S	DI.985.010
Fig. 2	M	DI.985.020
Fig. 3	L	DI.985.030



Upper / Superiori

No.	Size	A mm	B mm	Code / Codice
U0	XXS	66	55	DI.960.010
U1	XS	69	56	DI.960.020
U2	S	71	57	DI.960.030
U3	M	73	58	DI.960.040
U4	L	75	62	DI.960.050
U5	XL	78	64	DI.960.060

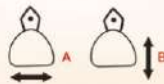

Upper left / Lower right
Superiore sinistra / Inferiore destra



No.	Size	Code / Codice
Fig. 1	S	DI.980.010
Fig. 2	M	DI.980.020
Fig. 3	L	DI.980.030



DI.970.000
Set of 12 pieces / Serie di 12 pezzi
Contents / Contenuto
L0, L1, L2, L3, L4, L5, U0, U1, U2, U3, U4, U5

iD-Color

Silicone buttons for impression trays / Bottoni in silicone per porta impronte

Fit any impression tray, easy identification of size
Adatti per qualsiasi modello in metallo Facilitano l'identificazione della misura



DI.999.000
Assorted pack of 24 buttons
6 colors, 4 of each color
Confezione di 24 colori assortiti,
6 colori/4 di ciascun colore



Model and impression shipping cases
Contenitori di protezione per impronte e modelli



DL.093.010
for model / per modelli

DL.093.020
for impression tray / per porta impronte

Plastic model bases / Basi in plastica per modelli



Complete upper and lower with hinges
Superiore e inferiore unite da cerniera

DL.090.010 Standard / Standard
DL.090.020 Large / Grande

Rubber model bases
Basi in gomma per modelli

Set of 6 pieces, assorted sizes, upper and lower
Serie di 6 pz. superiori e inferiori, misure assortite



DL.091.010

Disposable model base formers
Stampi monouso



Pack of 20 pieces
Conf. 20 pezzi

DL.092.010 Small / Piccolo
DL.092.020 Medium / Medio
DL.092.030 Large / Grande

Laboratory Instruments / Strumenti per Laboratorio



Micro torches / Micro bruciatori

- Instant electronic ignition
- Precise adjustable flame
- Temperature up to 2450°F/1343°C
- Accensione elettronica
- Fiamma regolabile
- Temperatura fino a 1343°C



DL.1000.00
Hand held or free standing
Con supporto



DL.1010.00

Alcohol lamp deluxe / Lampada ad alcool deluxe



DL.015.010
Small / Piccola
DL.015.020
Large / Grande

Spare wicks (pack of 5)
Stoppino di ricambio (conf. 5 pz.)



DL.019.020

Alcohol lamp standard / Lampada ad alcool



DL.010.000

Spare wicks (pack of 5)
Stoppino di ricambio (conf. 5 pz.)



DL.019.010

Glass alcohol lamp / Lampada ad alcool in vetro



DL.009.000

Spare wicks (pack of 5)
Stoppino di ricambio (conf. 5 pz.)



DL.019.010

Articulators / Articolatori



Fig. 50
DL.025.050
Full arch
Arcata totale



Fig. 51
DL.025.051
Full denture
Protesi totale



Fig. 57
DL.025.057
Crown & bridge
Ponti e corone

Brass articulators / Articolatori in ottone



Fig. 50
DL.024.050
Full arch
Arcata totale



Fig. 51
DL.024.051
Full denture
Protesi totale



Fig. 57
DL.024.057
Crown & bridge
Ponti e corone

Colored articulators / Articolatori colorati



Fig.50



Fig.51



Fig.57

Black / Nero	DL.026.150	DL.026.151	DL.026.157
Blue / Blu	DL.026.250	DL.026.251	DL.026.257
Red / Rosso	DL.026.550	DL.026.551	DL.026.557
Yellow / Giallo	DL.026.850	DL.026.851	DL.026.857

Occlusor / Occlusore



DL.027.000



BEST SELLER



Falcon Deluxe
DL.050.000

DL.050.000
Falcon Deluxe Articulator

- Contents:
1 x Articulator unit
10 x Mounting plates (DL.050.001)
2 x Complete magnetic plates (DL.050.002)
10 x Cast fastening washers (DL.050.003)

Articolatore Falcon Deluxe

- Contenuto:
1 x Articolatore
10 x Piastrina portamodello (DL.050.001)
2 x Piastrina magnetica completa (DL.050.002)
10 x Rondelle per fissaggio modelli (DL.050.003)



Falcon
DL.040.000

DL.040.000
Falcon Articulator

- Contents:
1 x Articulator unit
2 x Mounting plates (DL.050.001)

Articolatore Falcon

- Contenuto:
1 x Articolatore
2 x Piastrina portamodello (DL.050.001)



01



02



03



04

Spare parts:

- 01 **DL.050.001** Mounting plates (pack of 10)
- 02 **DL.050.002** Complete magnetic plate
- 03 **DL.050.003** Cast fastening washers (pack of 10)
- 04 **DL.050.004** Spare Magnet

Parti di Ricambio:

- 01 **DL.050.001** Piastrina portamodello (conf. 10 pz.)
- 02 **DL.050.002** Piastrina magnetica completa
- 03 **DL.050.003** Rondelle per fissaggio modelli (conf.10 pz.)
- 04 **DL.050.004** Medaglia magnetica di ricambio



DL.060.000
Plasterless articulator
Articolatore senza gesso

DL.039.000
Deluxe Articulator
Articolatore Deluxe



DL.039.000

DL.039.001
Spare pins (pair)
Coppia di spilli di ricambio

DL.038.000
Deluxe Magnetic Articulator

- Contents:
1 x Articulator unit
2 x Complete magnetic plates (DL.038.002)
10 x Cast fastening washers (DL.038.003)



DL.038.000

Articolatore Deluxe con piastrina magnetica

- Contenuto:
1 x Articolatore
2 x Piastrina magnetica completa (DL.038.002)
10 x Rondelle per fissaggio modelli (DL.038.003)



01



02



03

Spare parts:

- 01 **DL.038.002** Complete magnetic plate
- 02 **DL.038.003** Cast fastening washers (pack of 10)
- 03 **DL.038.004** Spare Magnet

Parti di Ricambio:

- 01 **DL.038.002** Piastrina magnetica completa
- 02 **DL.038.003** Rondelle per fissaggio modelli (conf.10 pz.)
- 03 **DL.038.004** Medaglia magnetica di ricambio

DL.045.000
Articulator

- Contents:
1 x Articulator unit
2 x Complete magnetic plates (DL.045.001)
10 x Cast fastening washers (DL.045.002)



DL.045.000

Articolatore

- Contenuto:
1 x Articolatore
2 x Piastrina magnetica completa (DL.045.001)
10 x Rondelle per fissaggio modelli (DL.045.002)



01



02



03

Spare parts:

- 01 **DL.045.001** Complete magnetic plate
- 02 **DL.045.002** Cast fastening washers (pack of 10)
- 03 **DL.038.004** Spare magnet

Parti di Ricambio:

- 01 **DL.045.001** Piastrina magnetica completa
- 02 **DL.045.002** Rondelle per fissaggio modelli (conf.10 pz.)
- 03 **DL.038.004** Medaglia magnetica di ricambio

Calipers / Calibri

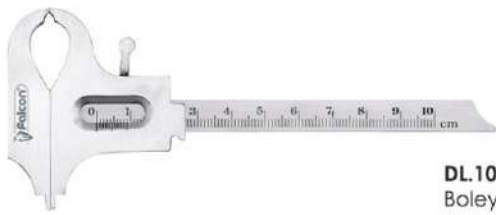

DL.100.010
 Boley
 Measuring range / Misurazione
 0 - 100 mm



DL.101.030
 Iwanson
 for metal / per metallo
 Measuring range / Misurazione
 0-10 mm



DL.100.020
 Boley
 Measuring range / Misurazione
 0 - 100 mm



DL.101.040
 Iwanson
 for wax / per cera
 Measuring range / Misurazione
 0-10 mm

Crown Grippers / Pinze per corone

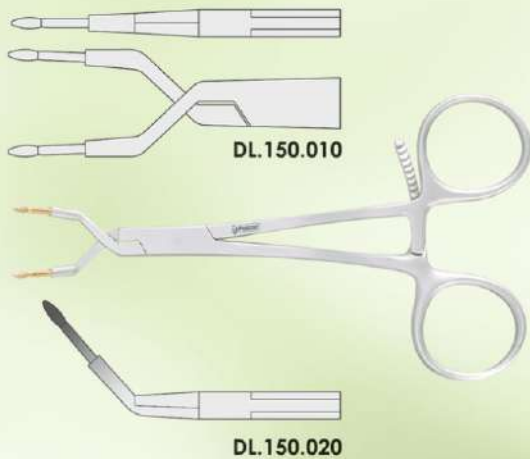

DL.150.010

DL.150.020

Crown scissors / Forbici per corone

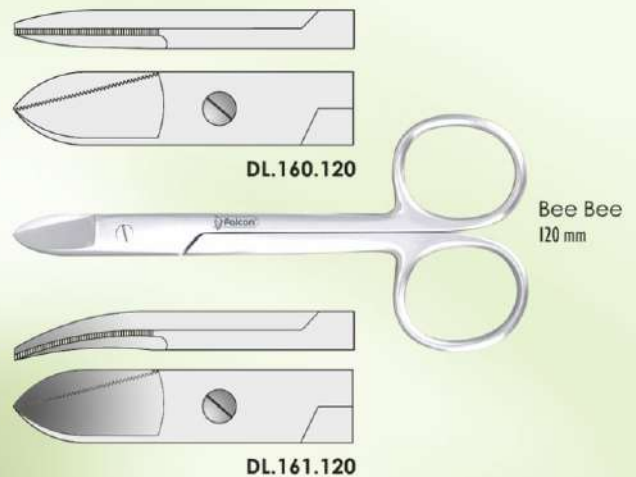

DL.160.120

Bee Bee
 120 mm

DL.161.120

Riveting Mallets / Martelletti per rivettare

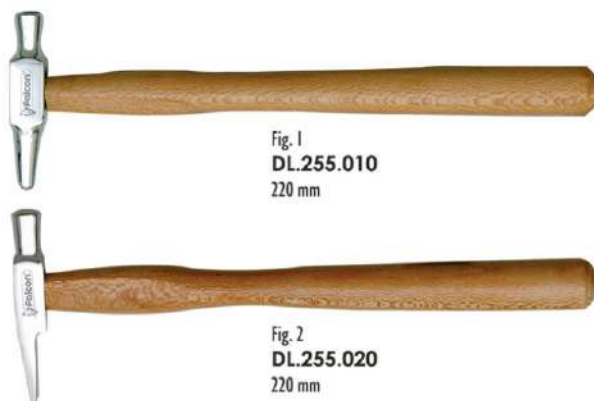
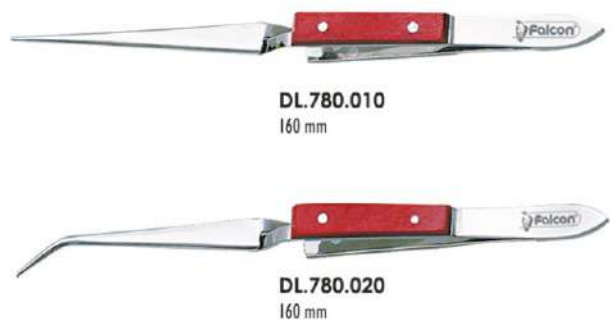

Fig. 1
DL.255.010
 220 mm

Fig. 2
DL.255.020
 220 mm

Soldering tweezers / Pinzette per saldatura



DL.780.010
 160 mm

DL.780.020
 160 mm



Anvil / Incudine
DL.020.010
 L 110 x W 30 x H 40 mm
 Carbon steel / Ghisa



Furnace Tongs and Tweezers / Pinze per cilindri e muffole



DL.700.310
310 mm



DL.705.400
400 mm



DL.715.560
560 mm



DL.790.200 **DL.790.300**
200 mm 300mm

Fret saw and blades / Archetto e lame



DL.650.000

DL.650.010
Saw blades for metal / Lame per metallo
Pack of 12 pieces / Conf. 12 pezzi

DL.650.020
Saw blades for plaster / Lame per gesso
Pack of 12 pieces / Conf. 12 pezzi

Modeling saw and blades / Seghetto per modelli e lame



DL.655.000

DL.655.010
0.25 x 3 mm Pack of 12 pieces / Conf. 12 pezzi

DL.655.020
0.25 x 5 mm Pack of 12 pieces / Conf. 12 pezzi

DL.655.030
0.12 x 5 mm Pack of 12 pieces / Conf. 12 pezzi

Plaster cutters / Cesoia taglia gesso



DL.325.200 **DL.326.200**
Straight / Dritta Curved / Curva
200 mm 200 mm

Bowls for plaster and alginate
Tazze per alginate e gesso



■ Silicone
Green / Verde

□ Polyethylene
White / Bianco

ø 100 mm **DL.500.011**

DL.501.017

ø 120 mm **DL.500.021**

DL.501.027

ø 140 mm **DL.500.031**

DL.501.037

ø 160 mm **DL.500.041**

Plaster knives with bakelite handle autoclavable
Coltelli per gesso con manico in bakelite autocavabile

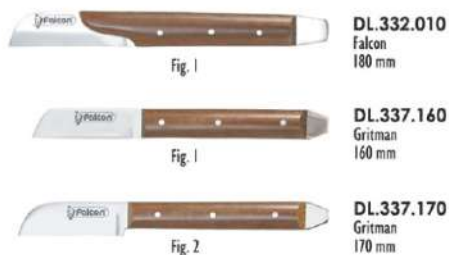

Plaster knives with wooden handle
Coltelli per gesso con manico di legno



Plaster knives with colored plywood handle
Coltelli per gesso con manico in compensato colorato



Spatulae rigid
Spatole rigide



Spatulae flexible
Spatole flessibili





Flexible plastic spatulae / Spatole flessibili in plastica



Flexible plastic
Flessibile in plastica
185 mm

	Blue Dark	Blu	DL.461.010
	Green	Verde	DL.461.020
	Orange	Arancione	DL.461.030
	Pink	Rosa	DL.461.040
	Red	Rosso	DL.461.050
	White	Bianco	DL.461.060
	Yellow	Giallo	DL.461.070



DL.460.010
Falcon
Super flexible plastic
Superflessibili in plastica
190 mm



Wax knives with plastic handle, non-autoclavable
Coltelli per cera con manico in plastica, non-autoclavabili



	Black	Nero	DL.815.050	Fahnenstock 130 mm	Fahnenstock 175 mm	DL.815.060
	Blue	Blu	DL.815.051			DL.815.061
	Green	Verde	DL.815.052			DL.815.062
	Red	Rosso	DL.815.053			DL.815.063
	White	Bianco	DL.815.054			DL.815.064
	Yellow	Giallo	DL.815.055			DL.815.065

Wax knives with plastic handle, non-autoclavable
Coltelli per cera con manico in plastica, non-autoclavabili



	Black	Nero	DL.825.050	Lessmann 130 mm	Lessmann 175 mm	DL.825.060
	Blue	Blu	DL.825.051			DL.825.061
	Green	Verde	DL.825.052			DL.825.062
	Red	Rosso	DL.825.053			DL.825.063
	White	Bianco	DL.825.054			DL.825.064
	Yellow	Giallo	DL.825.055			DL.825.065

Wax knives with wooden handle
Coltelli per cera con manico di legno



DL.805.010	con scodellino	130 mm
DL.805.020	con scodellino	175 mm
DL.815.010	Fahnenstock	130 mm
DL.815.020	Fahnenstock	175 mm
DL.825.010	Lessmann	130 mm
DL.825.020	Lessmann	175 mm

Wax knives with bakelite handle, autoclavable
Coltelli per cera con manico in bakelite, autoclavabile



DL.815.070	Fahnenstock	130 mm
DL.815.080	Fahnenstock	175 mm
DL.825.070	Lessmann	130 mm
DL.825.080	Lessmann	175 mm

Wax knives with metal handle, autoclavable
Coltelli per cera con manico in metallo, autoclavabili

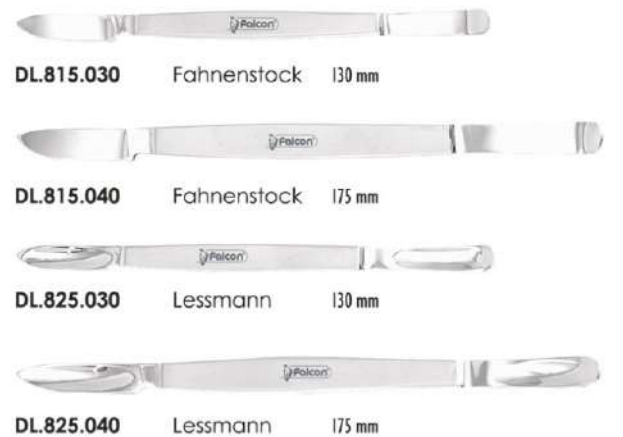

DL.815.030	Fahnenstock	130 mm
DL.815.040	Fahnenstock	175 mm
DL.825.030	Lessmann	130 mm
DL.825.040	Lessmann	175 mm

Wax knives Ermert
Coltelli per cera Ermert



DL.810.010	Wooden handle / Manico di legno
DL.810.030	Plastic handle / Manico in plastica
DL.810.020	Metal handle / Manico in metallo

Ceramic sculpturing instruments / Strumenti per ceramica

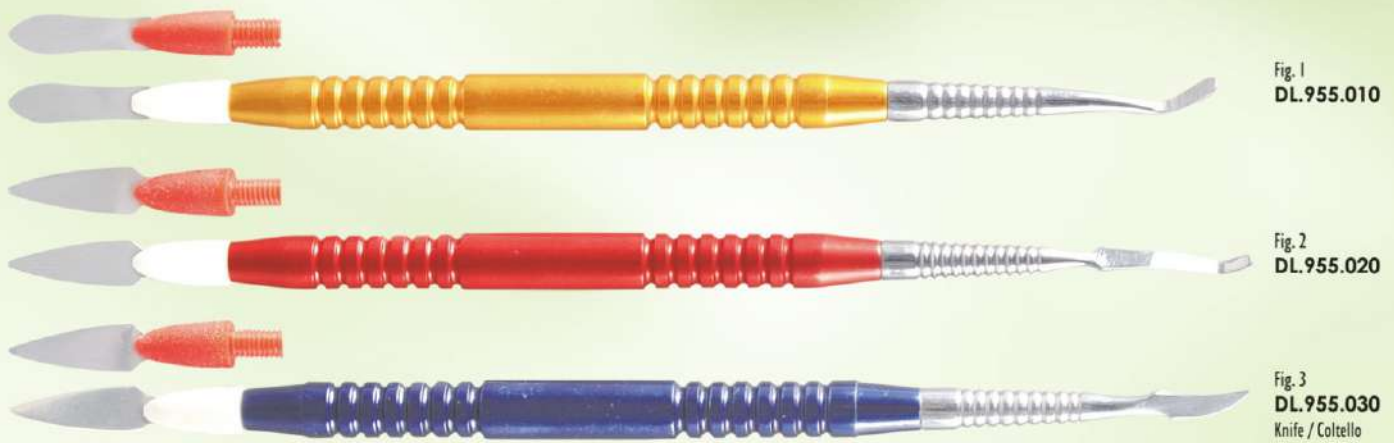

Flexible / Flessibili



Super flexible / Superflessibili



Modeling carvers / Strumenti per modellare
P.K. Thomas





P.K. Thomas



Fig. 1 DL.904.010



Fig. 2 DL.904.020



Fig. 4 DL.904.040



Fig. 3 DL.904.030



Fig. 5 DL.904.050



DL.904.000
Set of 5 / Serie da 5



DL.900.000
Set of 5 / Serie da 5

P.K. Thomas



Fig. 1 DL.900.010



Fig. 2 DL.900.020



Fig. 4 DL.900.040



Fig. 3 DL.900.030



Fig. 5 DL.900.050



Fig. 7 DL.856.070 Beale



Fig. 31 DL.870.314 Gritman



Fig. 10 DL.880.100 Lecron



Fig. 10 DL.875.100 Hylin



Fig. 10 DL.945.100 Zahle



Fig. 1 DL.932.010 Vehe



Fig. 13 DL.864.130 Falcon



Fig. 31 DL.870.310 Gritman



Fig. 1 DL.855.010 Beale



Fig. 12 DL.864.120 Falcon



Fig. 1 DL.918.010 Roach

Wax Modeling Carvers
Strumenti per Modellare



Fig. 1 DL.864.010 Falcon 130 mm	Fig. 2 DL.864.020 Falcon 140 mm	Fig. 3 DL.864.030 Falcon 140 mm	Fig. 4 DL.864.040 Falcon 135 mm	Fig. 5 DL.864.050 Falcon 140 mm	Fig. 6 DL.864.060 Falcon 117 mm	Fig. 7 DL.864.070 Falcon 115 mm	Fig. 1 DL.945.010 Zahle 120 mm	Fig. 2 DL.945.020 Zahle 125 mm	Fig. 3 DL.945.030 Zahle 125 mm	Fig. 4 DL.945.040 Zahle 120 mm	Fig. 5 DL.945.050 Zahle 120 mm	Fig. 6 DL.945.060 Zahle 115 mm
---	---	---	---	---	---	---	--	--	--	--	--	--

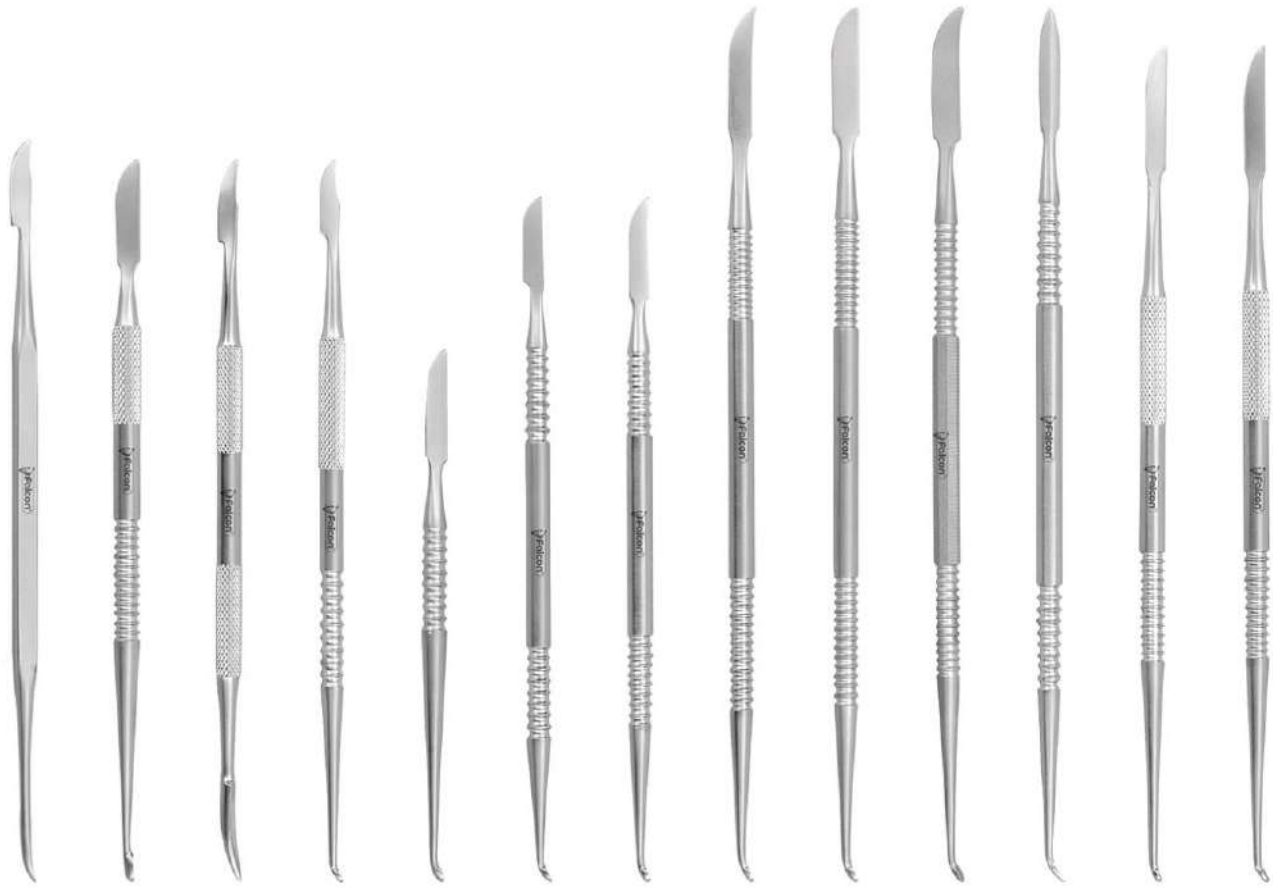

Fig. 1 DL.875.010 Hylin 135 mm	Fig. 3 DL.875.030 Hylin-Ceramica 135 mm	Fig. 5 DL.875.050 Hylin-Falcon 135 mm	Fig. 6 DL.875.060 Hylin-Lecron 135 mm	Fig. 1 DL.882.010 Lecron-Mini 100 mm	Fig. 2 DL.882.020 Lecron-Mini 130 mm	Fig. 3 DL.882.030 Lecron-Mini 130 mm	Fig. 1 DL.880.010 Lecron 165 mm	Fig. 2 DL.880.020 Lecron 165 mm	Fig. 3 DL.880.030 Lecron 165 mm	Fig. 4 DL.880.040 Lecron 165 mm	Fig. 7 DL.880.070 Lecron 160 mm	Fig. 8 DL.880.080 Lecron 160 mm
--	---	---	---	--	--	--	---	---	---	---	---	---

Laboratory

Tungsten Carbide Burs

- Made of high quality Tungsten Carbide
- Precision toothing, superior cutting and durable
- Perfectly concentric
- Available in x-fine, fine, coarse and x-coarse grits
- Color coded according to grit type
- Standard ISO patterns



Fresoni al carburo di tungsteno

- Prodotte con Carburo di tungsteno di elevata qualità
- Dentatura di precisione, qualità di taglio e durata superiori
- Perfetta concentricità
- Disponibili con grana in X-fine, fine, grossa, extra grossa.
- Grana identificata secondo il colore
- Modelli secondo gli standards ISO



Cross Cut Fine (ISO-No. 140), Red

For delicate and difficult trimming of hard alloys, acrylics and ceramics / Per rifinire con precisione e delicatezza leghe dure, acrilico e ceramica

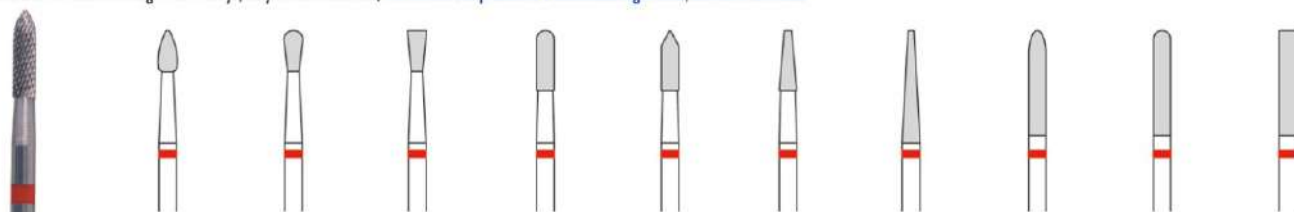

Shank	ISO No.	DB.9257.233	DB.9237.233	DB.9255.233	DB.9140.233	DB.9289.233	DB.9198.233	DB.9187.233	DB.9292.233	DB.9137.233	DB.9116.233
HP	500 104...	... 257..140	... 237..140	... 255..140	... 140..140	... 289..140	... 198..140	... 187..140	... 292..140	... 137..140	... 116..140
	Ø mm	2,3	2,3	2,3	2,3	2,3	2,3	2,3	2,3	2,3	2,3
	L1 mm	5,5	5,5	5,5	8,0	8,0	8,0	15,0	14,0	14,0	14,0
	L2 mm	45,0	45,0	45,0	45,0	45,0	45,0	45,0	45,0	45,0	45,0

Cross Cut Fine (ISO-No. 140), Red

For delicate and difficult trimming of hard alloys, acrylics and ceramics / Per rifinire con precisione e delicatezza leghe dure, acrilico e ceramica

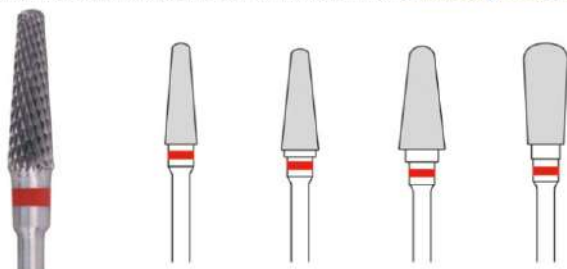

Shank	ISO No.	DB.9194.403	DB.9194.503	DB.9194.603	DB.9237.603
HP	500 104...	... 194..140	... 194..140	... 194..140	... 237..140
	Ø mm	4,0	5,0	6,0	6,0
	L1 mm	13,5	13,5	13,5	13,0
	L2 mm	52,0	52,0	52,0	52,0

Tungsten Carbide Burs Fresoni al Carburo di Tungsteno



Cross Cut X-Fine (ISO-No. 141), Yellow

For fine, precise trimming of ceramics, precious metals and all non-precious alloys / Per rifinire con precisione ceramica, metalli preziosi e leghe non preziose

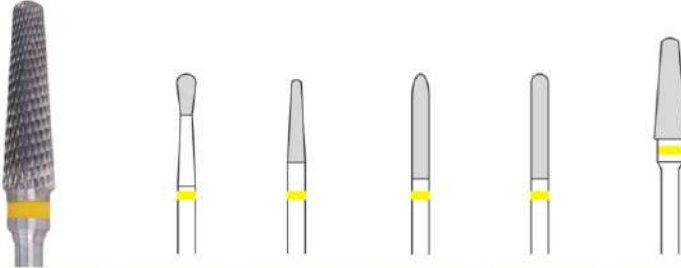

Shank	ISO No.	DB.9237.232	DB.9199.232	DB.9292.232	DB.9137.232	DB.9194.402
HP	500 104...	... 237..141	... 199..141	... 292..141	... 137 141	... 194..141
	Ø mm	2,3	2,3	2,3	2,3	4,0
	L1 mm	5,5	11,5	14,0	14,0	13,5
	L2 mm	45,0	45,0	45,0	45,0	52,0

Cross Cut Coarse (ISO-No. 220), Green

For trimming large surfaces of acrylics, tray materials and plaster / Per rifinire grandi superfici di acrilico, materiali da impronta e gesso

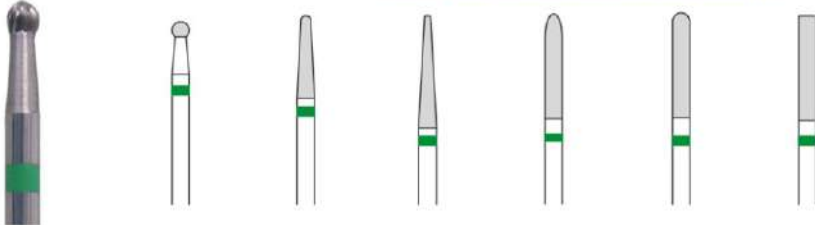

Shank	ISO No.	DB.9001.235	DB.9199.235	DB.9187.235	DB.9292.235	DB.9137.235	DB.9116.235
HP	500 104...	... 001 220	... 199..220	... 187..220	... 292..220	... 137 220	... 116 220
	Ø mm	2,3	2,3	2,3	2,3	2,3	2,3
	L1 mm	2,3	11,0	15,5	2,3	14,0	14,0
	L2 mm	45,0	45,0	45,0	45,0	45,0	45,0

Cross Cut Coarse (ISO-No. 220), Green

For trimming large surfaces of acrylics, tray materials and plaster / Per rifinire grandi superfici di acrilico, materiali da impronta e gesso

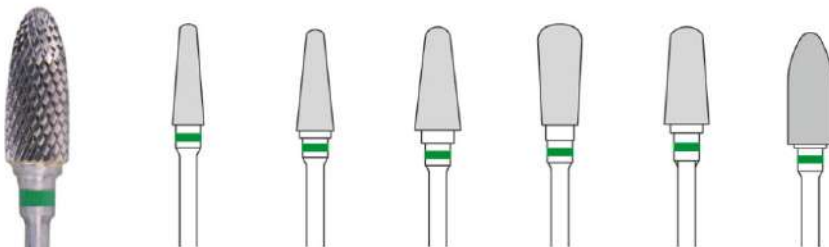

Shank	ISO No.	DB.9194.405	DB.9194.505	DB.9194.605	DB.9237.605	DB.9263.605	DB.9274.605
HP	500 104...	... 194-220	... 194..220	... 194..220	... 237..220	... 263..220	... 274..220
	Ø mm	4,0	5,0	6,0	6,0	6,0	6,0
	L1 mm	13,5	13,5	13,5	13,0	13,0	14,0
	L2 mm	52,0	52,0	52,0	52,0	52,0	52,0

Cross Cut X-Coarse (ISO-No. 224), Black

The optimum for plaster — also wet plaster / Ottimali per gesso anche umido

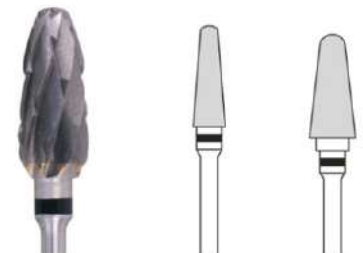

Shank	ISO No.	DB.9194.408	DB.9194.608
HP	500 104...	... 194..224	... 194..224
	Ø mm	4,0	6,0
	L1 mm	13,5	13,5
	L2 mm	52,0	52,0

Orthodontic / Ortodonzia





Instruments for "Fixed Appliance Technique" Strumenti per Ortodonzia Fissa

Measuring instruments / Strumenti di misurazione

DO.151.000
Falcon



Bow divider, to measure tooth width, bracket distance to the incisal edge etc.
Autoclavable

Compasso ortodontico per la misurazione dei denti, la distanza degli attacchi dall'asse incisale, ecc.
Autoclavabile

DO.160.000
Bernklau



Orthodontic ruler, Perfect for all diagnostic measurements, both intraoral and on the model
Autoclavable

Regolo ortodontico, Ideale per tutte le misurazioni diagnostiche intra-orali o sul modello
Autoclavabile

DO.170.000
Beerendonk



Dental vernier with long and fine tips for intraoral measurements
Autoclavable
Nonio dentale con punte lunghe e sottili per misurazioni intraorali
Autoclavabile



DO.165.150 150 mm / 6"
DO.165.300 300 mm / 12"

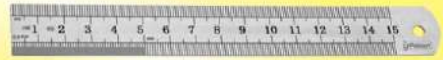

Ruler stainless steel
Righello in acciaio inox

DO.172.000
Falcon

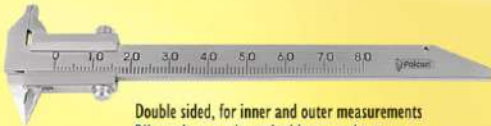

Double sided, for inner and outer measurements
Bilaterale, per misurazioni interne ed esterne

DO.175.000

Orthodontic bow compass / Compasso ortodontico



DO.180.000
Dynamometer
Dinamometro

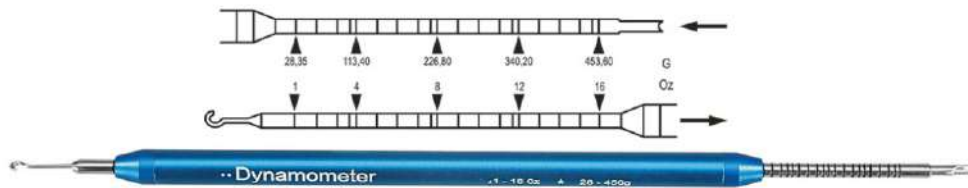

High precision gauge for measuring tensile and compression forces exerted by springs and elastics for a maximum range of 16 oz. (453gm). It is calibrated with 1 oz. single line and 4 oz. double line increments.

Strumento di misura di estrema precisione per misurare la forza delle molle o degli elastici, sia in trazione che in pressione, fino ad un massimo di 453 gm. Gli intervalli corrispondono a 28,5 gm. (lineetta singola) e a 114 gm. (lineetta doppia).

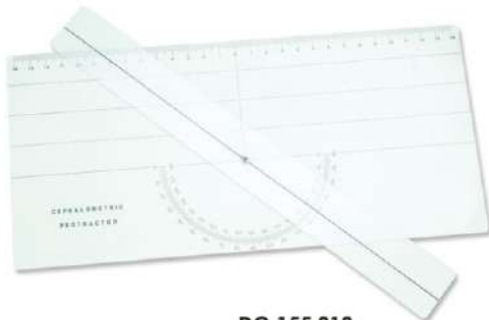

DO.155.010
Template cephalometric / Normografo cefalometrico



DO.155.030
Template correlometer / Normografo correlometer

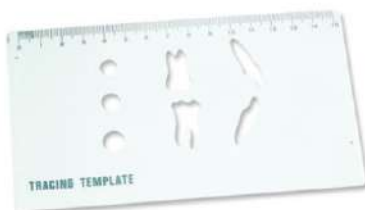

DO.155.020
Template tracing / Normografo tracing

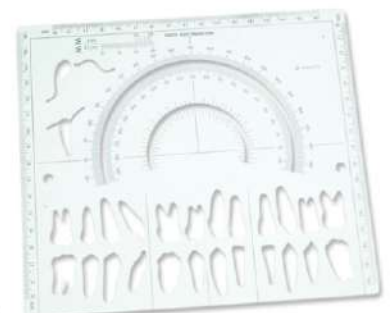

DO.155.040
Template Ricketts / Normografo Ricketts



Instruments for "Fixed Appliance Technique" Strumenti per Ortodonzia Fissa



Instruments for bands and buccal tubes / Strumenti per bande e per tubetti buccali



Band pusher with serrated rectangular tip for good transfer of force when positioning bands
Spingibande con punta rettangolare zigrinata per una pressione ideale durante il posizionamento delle bande



DO.120.010
Mershon



Band seating instrument with hard metal triangular serrated tip, autoclavable
Posizionatore di bande con punta triangolare zigrinata, autoclavabile



DO.125.010
Falcon



DO.227.120 120 mm
DO.227.135 135 mm
Keat



Buccal tube tweezers
Fine pointed tips firmly grip buccal tube within slot for accurate placement
Curved tips for easy access and maximum visibility
Pinzetta per tubetti buccali.
Le punte fini trattengono il tubetto buccale attraverso lo slot per un posizionamento accurato
La particolare forma delle punte coniuga facilità di accesso con massima visibilità



DO.228.125 125 mm
DO.228.135 135 mm
Falcon

Reverse action buccal tube tweezers
Firmly hold buccal tube within the slot when the tweezer is relaxed and releases it when pressure is applied
Can also be used as reverse action tweezers for placing brackets
Pinzetta per tubetti buccali ad azione invertita.
Una volta rilasciata le punte fini trattengono il tubetto buccale attraverso lo slot per un posizionamento accurato
La particolare forma delle punte coniuga facilità di accesso con massima visibilità
Lo strumento può essere impiegato anche come posizionatore di attacchi ad azione invertita



DO.145.010 **Gum flap retractor**
Useful instrument for lifting gum while banding of second molar stainless steel, autoclavable
Retrattore gengivale
Utile strumento per sollevare il tessuto morbido gengivale ed agevolare il posizionamento delle bande sui secondi molari, In acciaio Inox, autoclavabile

Scaler and band pushing Instruments
Sharp scaling tip on one end and serrated band pusher on the other

Scaler / Spingibande
Da un lato scaler (per asportare p.e. residui di collante) e dall' altro spingibande



DO.130.010



DO.130.014



Disc safety guards set
Protects patients gums, lips and cheeks from rotating discs
Set riparo di sicurezza
Protegge gengive, labbra e guance del paziente dai dischi rotanti

DO.300.000
Contents / Contenuto:
1 x Shaft / Supporto
1 x 8mm Guard / Schermo da 8mm
1 x 16mm Guard / Schermo da 16mm
1 x 22mm Guard / Schermo da 22mm



Instruments for interdental stripping Strumento per abrasione interdentale manuale

Manual interdental stripper
Applications:
Opening tight contacts between teeth to fix molar bands
General contouring of a tooth
Removal of calculus from contact areas
Finishing of proximal surfaces

Strumento manuale per abrasione interdentale
Applicazioni:
Apertura di contatti fra i denti per il fissaggio di bande molari
Asportazione di tartaro dall'area di contatto
Finitura di superfici prossimali

DO.298.000



Manual interdental stripper handle only **Manico per abrasione interdentale**
Securely holds all types of abrasive strips **Trattiene positivamente tutti i tipi di striscie**

Abrasive strips / Striscie abrasive



DO.299.041
Coated on one side,
4 mm wide (Pack of 12)
Abrasive su un solo lato
4 mm (12 pezzi)



Instruments for "Fixed Appliance Technique" Strumenti per Ortodonzia Fissa

Instruments for D.B. brackets / Strumenti per attacchi D.B.



Bracket positioning gauge
Facilitate bracket positioning to exact desired distance by measuring its height, from slot to incisal / occlusal surface of tooth
Calibro per il posizionamento degli attacchi
Facilita l'ideale posizionamento dell'attacco mediante misurazione dallo slot alla superficie incisale / occlusale del dente



DO.200.010
Boone

Universal for both .018" or .022" slot brackets
Four different heights for bracket positioning: 3.5, 4, 4.5, & 5 mm
Stainless Steel, autoclavable
Universale per attacchi con slot di .018" o .022".
Consente il posizionamento dell'attacco a quattro diverse altezze: 3.5, 4, 4.5, e 5 mm
In acciaio inox, autoclavabile

Bracket placing tweezers Pinzette per posizionare attacchi



DO.210.135
135 mm



DO.217.135
135 mm



DO.220.110
110 mm



Falcon bracket positioning gauges
Four different heights for bracket positioning: 3.5, 4, 4.5, & 5 mm
Two different models for .018" or .022" slot brackets anodized aluminum, autoclavable
Calibri per il posizionamento degli attacchi Falcon
adatto per slot di .018" o .022" consente il posizionamento dell'attacco a quattro diverse altezze: 3.5 mm, 4 mm, 4.5 mm e 5 mm
In alluminio anodizzato, autoclavabile



DO.205.018 For .018" slot brackets / Per attacchi con slot .018"
DO.205.022 For .022" slot brackets / Per attacchi con slot .022"



Bracket placer for posterior teeth
Very helpful instrument for placing D.B. brackets from bicuspids to molars, the small head offers excellent view
Strumento per posizionare gli attacchi per denti posteriori
Utilissimo per posizionare gli attacchi D. B. dai bicuspidi ai molari. La testa di piccole dimensioni consente un eccellente campo visivo



DO.209.010



Bracket tweezers with slot aligner
Bracket holder on one end and slot aligner on the other. The rear end fits into the bracket slot for accurate placement



Pinzette per posizionare attacchi con allineatore
Un lato trattiene l'attacco, l'altro serve come allineatore di slot. La parte posteriore si innesta nello slot per un accurato posizionamento.



Fig. 1
DO.213.135
135 mm



Fig. 2
DO.214.135
135 mm



Fig. 3
DO.215.135
135 mm



Adhesive removers
For removing residue of adhesive from tooth after removal of D.B. Bracket.

Strumento per rimuovere residui di adesivo
Doppio ablatore ideale per rimuovere i residui di adesivo una volta tolti gli attacchi D. B.

Classic-Round

6 mm solid handle
Manico pieno da 6mm



DO.235.010

SOFT LINE INSTRUMENTS
soft and sure grip



DO.235.014



Instruments for "Fixed Appliance Technique" Strumenti per Ortodonzia Fissa



Elastic ligature applicators
For easy placement of elastic ligatures under bracket tie wings.

Applicatore per legature elastiche
Facilita l'applicazione delle legature elastiche sugli attacchi.



DO.250.014



DO.250.010



DO.255.010
Aluminum handle

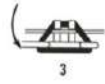
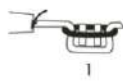

Elastomeric ligature removing instruments / Strumenti per rimuovere le legature



DO.258.014

Multi-purpose instrument, ligature tucker and elastomeric ligature remover
Strumento multi uso per ripiegare le legature e togliere legature elastiche



DO.365.014

Ligature tuckers

Used to tuck metal ligatures, also useful for inserting arch wires into bracket slots and applying elastic chains. Straight end is for anterior use and angled of posterior

Direzionatori di legature

Per ripiegare legature metalliche e anche per inserire gli archi negli slot e applicare catene elastiche. Lato dritto per uso anteriore, lato piegato per uso posteriore

SOFT LINE INSTRUMENTS
soft touch handle grip



DO.375.014



DO.376.014



DO.377.014

Classic Round

6 mm solid handle
Manico pieno da 6mm



DO.375.010



DO.376.010



DO.377.010



Instruments for "Fixed Appliance Technique" Strumenti per Ortodonzia Fissa

Distal end bending instruments

Very useful instrument for bending archwire distal ends to the buccal tube to create an easy cinch back bend in an area which is usually very hard to reach. Simply insert instrument to distal end of wire extracting through buccal tube and twist forward. Also can be used to bend tails of springs

Strumenti per piegature distali.

Di grande utilità per piegare distalmente tutti i fili in acciaio e NiTi in zone solitamente poco accessibili. Semplicemente inserire lo strumento e torcere in avanti. Può anche essere usato per piegare le estremità delle molle.



DO.240.010
For wire upto .022" (0.56 mm)
Per fili fino a .022" (0.56 mm)

DO.240.020
For wire upto .030" (0.76 mm)
Per fili fino a .030" (0.76 mm)



DO.241.010
For wire upto .022" (0.56 mm)
Per fili fino a .022" (0.56 mm)

DO.241.020
For wire upto .030" (0.76 mm)
Per fili fino a .030" (0.76 mm)

Lingual torquing key / Chiave linguale per ripiegare



DO.400.014

Niti ice instrument / Strumento 'a freddo' per fili NiTi



DO.245.010
Turns NiTi wire soft and flexible immediately for faster wire placement
Rende i fili NiTi malleabili e facilmente sostituibili



Turrets
For forming archwires, without torque, for wires .016" to .022" (0.41mm to 0.56mm)

Torrette
Per formare archi, senza torque, per fili .016" to .022" (0.41mm to 0.56mm)



DO.911.010
Made of stainless steel
Autoclavable
Realizzato in acciaio inox.
Autoclavabile



DO.910.010
Made of anodized Aluminum
Disinfectable
Realizzato in alluminio anodizzato.
Disinfettabile



Elastic ligature placing forceps
Pinze per posizionare le legature elastiche



Elastic ligature placing forceps with hook
Excellent for placing elastic ligatures, hook on tip provides non-slip grip of any type of elastomeric.
Pinze con gancio per posizionare le legature elastiche
Ideale per trattenere in maniera positiva qualsiasi tipo di legatura elastica grazie al gancio di cui è munita una punta



DO.290.120
Falcon
120 mm
Straight / Dritta



DO.291.120
Falcon
120 mm
Curved / Curva



DO.294.140
Falcon
140 mm



Elastic ligature placing forceps with groove
Excellent for placing elastic ligatures, grooved tip provides non-slip grip of any type of elastomeric.
Pinze con scanalatura per applicare legature elastiche
Ideale grazie alle punte scanalate che trattengono positivamente qualsiasi legatura elastica



DO.292.120
Falcon
120 mm



DO.295.140
Falcon
140 mm

Elastomeric ligature removing tweezers
For easy removal of elastomeric ligatures

Pinzette per rimuovere le legature
Facilitano la rimozione delle legature



DO.285.010

Separators placing pliers
For easy placement of radiopaque and non-radiopaque separators

Pinze per separatori
Facilita il posizionamento dei separatori radio e non-radiopachi.

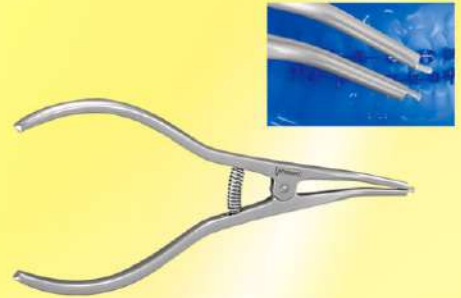

DO.270.160
160 mm

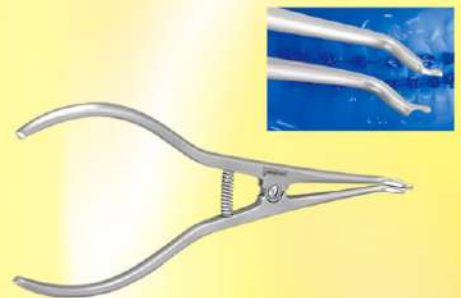

DO.271.165
165 mm



DO.270.155
155 mm

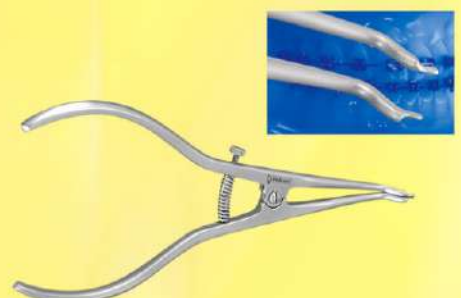

DO.272.165
165 mm



Instruments for "Fixed Appliance Technique"
Strumenti per Ortodonzia Fissa

Ligature tying pliers
Pinze per legature forzate

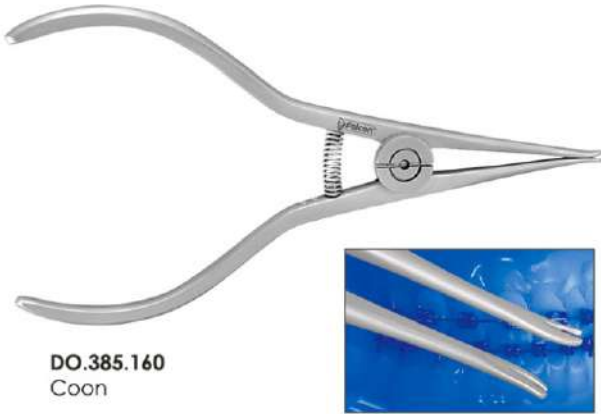

DO.385.160
Coon

Ligature tying pliers
 Most popular pliers for tying stainless steel ligatures. Unique cam design incorporates a precision-chamfered slot which automatically locks wire ends as tips spread
Pinza per legature forzate
 Pinza largamente usata per legature in acciaio inox. Lo snodo incorpora una scanalatura di precisione in grado di bloccare e trattenere le estremità dei fili esercitando pressione per aprire le punte.



DO.388.160
Steiner

Ligature tying pliers
 Dished tying cam for easy wrapping and V-notch for easy winding, cam extends away from the body for ease of winding and locking wire. Dished cam can be reversed for left-handed operators
Pinza per legature forzate
 Munita di un piattello con scanalatura a V che consente di avvolgere e bloccare il filo. Il piattello può essere posizionato su ciascuno dei due lati dello strumento per consentirne l'uso da parte di operatori ambidestri.

Ligature Pliers

Falcon offers wide variety of pliers for ligatures wires with or without tungsten carbide inserts.
 Falcon and Smaha pattern pliers have finer tips than standard Mathieu patterns, these are also suitable for placing elastic ligatures

Pinze per legatura

La Falcon offre una vasta varietà di pinze per legature con e senza riporti in carburo di tungsteno.
 I modelli Falcon e Smaha hanno le punte più fini dei Mathieu e sono quindi anche adatte a posizionare le legature elastiche



Falcon
140 mm



Smaha
140 mm

FALCON with tungsten carbide inserts
 con inserti al carburo di tungsteno



DO.393.030
Falcon
140 mm



Instruments for "Fixed Appliance Technique" Strumenti per Ortodonzia Fissa



Falcon

Band removers curved, left and right designed by Falcon

Curved tips provide easy access and grip of band without excess retraction of cheek or lips
Curved tips securely catches edge of band without slippage while pad rests on occlusal surface
Curved and heavy tips easily remove even stubborn bands

Falcon

Togli bande curvo destro e sinistro Ideato da Falcon

Togli bande curvo per consentire un facile accesso senza eccessiva retrazione di guance e labbra
Le punte curve trattengono positivamente l'estremità della banda mentre la pinza poggia sulla superficie occlusale
Le robuste punte piegate tolgono con facilità le bande più ostinate



Band removing pliers, left
Pinza sinistra per la rimozione di bande



DO.497.300
Falcon



Band removing pliers, right
Pinza destra per la rimozione di bande



DO.498.300
Falcon



Band seating pliers
Pinza per posizionare le bande



DO.502.300
Falcon

Falcon Band removing pliers

Safely and quickly removes posterior bands. Pad rests on occlusal surface and tip catches edge of band.

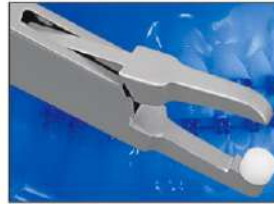

Falcon

Pinze per la rimozione di bande
Per la sicura e rapida rimozione di bande posteriori. La pinza poggia sulla superficie occlusale mentre le punte trattengono l'estremità della banda

Band removing pliers, long
Pinza lunga per la rimozione di bande



DO.492.300
Falcon



DO.495.010

Replacement pads 4.8 mm (1/4"), 2 pieces
Cuscinetti di ricambio 4,8 mm (1/4"), 2 pezzi

DO.495.020

Replacement pads 6.3 mm (3/16"), 2 pieces
Cuscinetti di ricambio 6,3 mm (3/16"), 2 pezzi



Contouring pliers
for contouring and adapting bands or crowns

Pinza per rifinire
Viene impiegata per arrotondare/adattare bande e corone.



DO.475.300
Reynolds



Contouring pliers
One convex and one concave tip for contouring and adapting bands or crowns

Pinza per rifinire
Con punte concavo/convessa.
Viene impiegata per arrotondare/adattare bande e corone



DO.465.300
Johnson



Instruments for "Fixed Appliance Technique" Strumenti per Ortodonzia Fissa

Buccal tube convertible cap removing pliers
Cuts off the temporary cap on a convertible first molar buccal tube when banding of second molar is required

Pinza per togliere i tappi dei tubetti buccali
Taglia il tappo temporaneo dei tubi buccali per consentire di estendere la banda dai premolari ai molari.



DO.505.300
Falcon



DO.505.010

Spare blade for DO.505.300 (2 Pieces)
Lama di ricambio per DO.505.300 (2 Pezzi)



Bracket removing pliers with plastic tip

Safely and quickly removes D.B. brackets, soft pad rest on incisal/occlusal surface of tooth for leverage and is comfortable for patient, sharp tip wedge the bracket base, one squeeze easily remove the bracket without extra force

Pinza con guarnizione in plastica per

Togliere gli attacchi in maniera veloce e sicura. La punta guarnita con plastica protegge la superficie incisale/occlusale del dente mentre l'altra si inserisce e fa leva sotto la base dell' attacco.

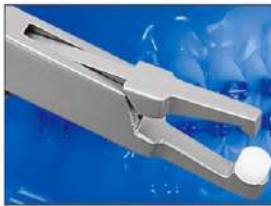

DO.520.300
Falcon



Bracket removing pliers

Tips wedge between both edges of the bracket base and tooth surface to remove bracket easily.

Pinze per rimuovere gli attacchi.

La rimozione dell' attacco è facilitata dall' azione leva tra la base dello stesso e la superficie del dente.



DO.510.300
Falcon

Bracket removing pliers angled

The 60° angled tip allows easy access to posterior brackets

Pinza ad angolo per la rimozione di attacchi Le punte a 60° facilitano l' accesso agli attacchi posteriori



DO.511.300
Falcon

Bracket removing pliers straight

Pinza dritta per la rimozione di attacchi



Distal end cutters with safety hold

- Falcon distal end cutters produce cleaner and closer cut than any other distal end cutter available in market
- Mini head offers easy access and better visibility
- Long handles give better control and leverage to user
- Fitted with un-breakable, corrosion resistant and durable stainless steel tips

Tronchesini distali con trattenuta del filo

- I tronchesini distali Falcon consentono un taglio più netto e ravvicinato di qualsiasi strumento equivalente disponibile sul mercato
- La testa piccola offre un facile accesso e migliore visibilità
- I lunghi manici consentono migliori controllo e leva
- Muniti di riporti in acciaio duro inox anti-rottura resistenti alla corrosione



DO.542.200
Falcon

Distal end cutter with safety hold, mini head, long handles
Mini tronchesino distale con trattenuta del filo, testa piccola, manici lunghi

●	Max. 0.30 mm to 0.50 mm (.012" to .020")
■	Max. 0.46 mm x 0.64 mm (.018" x .025")
⊗	Max. 0.38 mm to 0.53 mm (.0155" to .0215")
⊠	Max. 0.53 mm x 0.64 mm (.021" x .025")



DO.537.200
Falcon Micro

Distal end cutter with safety hold, micro head
Micro tronchesino distale con trattenuta del filo, testa piccola

●	Max. 0.30 mm to 0.50 mm (.012" to .020")
■	Max. 0.46 mm x 0.64 mm (.018" x .025")
⊗	Max. 0.38 mm to 0.53 mm (.0155" to .0215")
⊠	Max. 0.53 mm x 0.64 mm (.021" x .025")



DO.544.200
Falcon

Distal end cutter with safety hold, mini head, long off-set handles give better control, leverage and visibility to user
Mini tronchesino distale con trattenuta del filo, testa piccola, manici lunghi dissasati I manici lunghi dissasati offrono maggiori controllo, leva e visibilità

●	Max. 0.30 mm to 0.50 mm (.012" to .020")
■	Max. 0.46 mm x 0.64 mm (.018" x .025")
⊗	Max. 0.38 mm to 0.53 mm (.0155" to .0215")
⊠	Max. 0.53 mm x 0.64 mm (.021" x .025")



DO.536.200
Falcon Mini

Distal end cutter with safety hold, mini head
Mini tronchesino distale con trattenuta del filo, testa piccola

●	Max. 0.30 mm to 0.50 mm (.012" to .020")
■	Max. 0.46 mm x 0.64 mm (.018" x .025")
⊗	Max. 0.38 mm to 0.53 mm (.0155" to .0215")
⊠	Max. 0.53 mm x 0.64 mm (.021" x .025")



DO.538.200
Falcon-Slender model

Distal end cutter with safety hold, mini head, long handles
Mini tronchesino distale con trattenuta del filo, testa piccola, manici lunghi



Instruments for "Fixed Appliance Technique" Strumenti per Ortodonzia Fissa

Hard wire cutters

Heavy box joint construction meaning longer cutting life without dis-alignment of tips
Fitted with un-breakable, corrosion resistant and durable stainless steel tips



DO.550.100
Falcon
Hard wire cutter, straight
Tronchesino dritto per fili duri



● Max. 0.30 mm to 0.50 mm (.012" to .020")
■ Max. 0.56 mm x 0.71 mm (.022" x .028")

Tronchesini per fili duri

La robusta cerniera assicura lunga durata ed evita il disallineamento delle punte
Muniti di riporti in acciaio duro inox anti-rottura resistenti alla corrosione



DO.555.100
Falcon
Hard wire cutter, 15° angled
Tronchesino per fili duri con angolo di 15°



● Max. 0.30 mm to 0.50 mm (.012" to .020")
■ Max. 0.56 mm x 0.71 mm (.022" x .028")



Falcon soft wire, pins and ligature cutters

Box joint construction for longer cutting life without dis-alignment of tips
Caution: Tips of these cutters are specifically horned to cut soft wire, not suitable for hard wires.



DO.571.200
Falcon-Mini
Soft wire and ligature cutter, Mini
Fitted with un-breakable, corrosion resistant and durable stainless steel tips
Mini tronchesino per legature e fili teneri
Muniti di riporti in acciaio duro inox anti-rottura resistenti alla corrosione



25 mm to 38 mm (.010" to .015")



Tronchesini Falcon per legature, perni e fili teneri

La robusta cerniera assicura lunga durata ed evita il disallineamento delle punte
Avvertenza: Le punte di questi strumenti sono affilate per tagliare fili teneri. Se ne sconsiglia l'uso con fili duri



DO.574.100
Falcon-Standard
Soft wire and ligature cutter, Standard
Fitted with un-breakable, corrosion resistant and durable stainless steel tips
Standard tronchesino per legature e fili teneri
Muniti di riporti in acciaio duro inox anti-rottura resistenti alla corrosione



25 mm to 38 mm (.010" to .015")



DO.565.200
Falcon-Micro
Soft wire and ligature cutter, Micro
Fitted with un-breakable, corrosion resistant and durable stainless steel tips
Micro tronchesino per legature e fili teneri
Muniti di riporti in acciaio duro inox anti-rottura resistenti alla corrosione



23 mm to 30 mm (.009" to .012")



DO.578.100
Falcon
Soft wire and ligature cutter, 45° angled
Fitted with un-breakable, corrosion resistant and durable stainless steel tips
Mini tronchesino per legature e fili teneri con angolo di 45°
Muniti di riporti in acciaio duro inox anti-rottura resistenti alla corrosione



25 mm to 38 mm (.010" to .015")



DO.571.300
Falcon
Soft wire and ligature cutter, Mini
Mini tronchesino per legature e fili teneri



25 mm to 38 mm (.010" to .015")



DO.565.300
Falcon
Soft wire and ligature cutter, Micro
Micro tronchesino per legature e fili teneri



23 mm to 30 mm (.009" to .012")



DO.585.300

Aderer

3-jaw wire bending pliers.

Precision aligned and contoured tips for consistent bends without damaging the wire.
Pinza con tre punte per piegare.

Punte realizzate con elevata precisione per piegare in modo uniforme senza danneggiare il filo



●	0.36 mm to 0.76 mm (.014" to .030")
■	Max. 0.56 mm x 0.71 mm (.022" x .028")



DO.590.300

Angel

Bird beak pliers with cutter.

Universal pliers with all wire bending and loop forming features of bird beak pliers plus cutter.
Pinza a becco d'uccello con tronchesino.

Pinza universale con tutte le caratteristiche per piegare e formare le anse munita anche di tronchesino



●	0.36 mm to 0.50 mm (.014" to .020")
■	Max. 0.41 mm x 0.56 mm (.016" x .022")



●	25"	25"
■	64 mm	64 mm

DO.592.300

Angel

Bird beak pliers

The most popular and versatile pliers for wire bending and loop forming, the tips are extremely fine for making small loops.
Pinza a becco d'uccello

La pinza più versatile e diffusa per piegare e formare anse



●	0.36 mm to 0.71 mm (.014" to .028")
■	Max. 0.56 mm x 0.71 mm (.022" x .028")



DO.602.300

De La Rosa

Arch forming and contouring pliers, without grooves. Matching concave and convex jaws for contouring and forming archwires without scoring or torquing.

Per formare e sagomare archi.
Le punte antagoniste concavo convesso agevolano la formazione e sagomatura di archi senza introdurre scanalature o torquing



●	0.36 mm to 0.50 mm (.012" to .020")
■	Max. 0.53 mm x 0.64 mm (.021" x .025")



DO.610.300

Falcon

Light wire bending and loop forming pliers.

Long and fine beaks for making smaller loops.
Pinza per piegare e formare anse con fili fini.
Le punte lunghe e fini consentono di realizzare anse molto piccole.



●	0.36 mm to 0.50 mm (.012" to .020")
■	Max. 0.41 mm x 0.56 mm (.016" x .022")



DO.618.300

Falcon

Lingual / palatal arch forming pliers.

Used to form double-back or triple-back bends in either .030" or .036" wire for insertion in lingual sheath.

Pinza per formare archi linguali e palatali.
E' indicata per formare pieghe doppie o triple con fili .030" o .036" per l'inserimento nell'apposita cannula linguale



●	0.76 mm (.030") / 0.91 mm (.036")
---	-----------------------------------



Instruments for "Fixed Appliance Technique" Strumenti per Ortodonzia Fissa

Rectangular arch forming and torquing pliers (Ribbon arch pliers)

Used to form offset and 90° bends on round or rectangular wire. Radiuses on tips edges do not score wire during torquing. Available in three different tip widths, tips are parallel at 0.5 mm opening.

Pinza per formare e applicare torque agli archi rettangolari.

Usata per piegare anche a 90° fili a sezione rotonda o rettangolare. Gli angoli arrotondati delle punte impediscono l'accidentale compressione del filo durante il torquing. Disponibile in tre diverse larghezze di punte. Le punte sono parallele con apertura di 0,5 mm.



DO.615.300 Falcon-Slim

Rectangular arch forming and torquing pliers, 0.64mm (.025") wide tips
Pinze per torquing e per formare archi rettangolari con punte di 0.64mm (.025") larghezza

- Max. 0.30 mm to 0.50 mm (.012" to .020")
- Max. 0.41 mm x 0.56 mm (.016" x .022")



DO.616.300 Falcon/Angel

Rectangular arch forming and torquing pliers, 1.27mm (.050") wide tips
Pinze per torquing e per formare archi rettangolari con punte di 1.27mm (.050") larghezza

- Max. 0.30 mm to 0.56 mm (.012" to .022")
- Max. 0.53 mm x 0.64 mm (.021" x .025")



DO.713.300 Tweed/Angel

Rectangular arch forming and torquing pliers, 1.78mm (.070") wide tips
Pinze per torquing e per formare archi rettangolari con punte di 1.78mm (.070") larghezza

- Max. 0.30 mm to 0.71 mm (.012" to .028")
- Max. 0.56 mm x 0.71 mm (.022" x .028")



Surgical ball hook crimping pliers

Used to crimp surgical ball hooks to arch wire, slotted tip fits over the base of hook for secure hold while crimping, also can be used to crimp stops and posts. Long handles for easy access to posterior region



Pinza per grippare ganci chirurgici e stop. Ideale per bloccare i ganci chirurgici sull'arco, può essere usata anche per il bloccaggio degli stop rettangolari e tondi. Manici lunghi per facilitare l'accesso alle regioni posteriori



DO.621.300 Falcon Straight / Dritta



DO.620.300 Falcon Angled / Ad angolo



Distal end bending pliers (Cinch Back/Tie Back)
Designed to bend distal end of wire extracting through buccal tube away from cheek. Angled tips and long handles allow easy access to posterior region

Tronchesino per ripiegature distali
Ideato per piegare i distali del filo che fuoriesce dal tubo boccale. La forma ad angolo delle punte ed i manici lunghi consentono un facile accesso alle zone posteriori



DO.623.300 Falcon

- Max. 0.30 mm to 0.50 mm (.012" to .020")
- Max. 0.56 mm x 0.71 mm (.022" x .028")



Multipurpose pliers, useful for placement and removal of archwires and auxiliaries. Tips are serrated to securely hold wire, the jaws are bowed and contact only at tips to prevent lip pinching, box joint design for stability.

Pinza multiuso ideale per posizionare e rimuovere archi e ausiliari. Il contatto si verifica solo in punta per evitare di pizzicare le labbra. Le superfici in contatto delle punte sono zigrinate per trattenere in maniera positiva il filo. Snodo costruito per assicurare massima stabilità.

Falcon with tungsten carbide inserts
con inserti al carburo di tungsteno

● 0.30 mm to 0.50 mm (.012" to .020")
■ Max. 0.56 mm x 0.71 mm (.022" x .028")



How Standard
4mm wide tips
Punte da 4 mm di larghezza



DO.662.100
Angled / Ad angolo



DO.661.100
Straight / Dritta

● 0.30 mm to 0.50 mm (.012" to .020")
■ Max. 0.56 mm x 0.71 mm (.022" x .028")

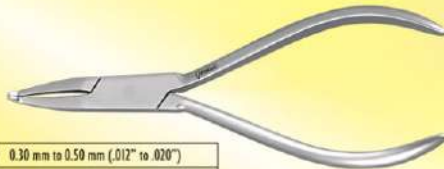

How Standard
4mm wide tips / punte da 4 mm di larghezza



DO.662.300
Angled / Ad angolo



DO.661.300
Straight / Dritta

● 0.30 mm to 0.50 mm (.012" to .020")
■ Max. 0.56 mm x 0.71 mm (.022" x .028")



How Mini
2.4 mm wide tips
Punte da 2.4 mm di larghezza



DO.665.300
Angled / Ad angolo



DO.664.300
Straight / Dritta



● 0.30 mm to 0.50 mm (.012" to .020")
■ Max. 0.46 mm x 0.56 mm (.018" x .022")

DO.675.300
Jarabak
Light wire bending pliers
Serrated tips and grooves assure accurate bending and closing of loops
Pinza per piegare fili fini.
Le punte zigrinate e le scanalature consentono di realizzare anse di precisione.



● 0.36 mm to 0.71 mm (.014" to .028")
■ Max. 0.56 mm x 0.71 mm (.022" x .028")

DO.688.300
Nance
Loop forming pliers
Four steps beak for making precision loops of 3, 4, 5 or 6 mm in round or rectangular wires. One tip is serrated to prevent wire slippage
Pinza per formare le anse
Le punte con quattro gradini consentono di realizzare con precisione anse di 3, 4, 5, o 6 mm sia con fili a sezione tonda che quadrangolare. Una delle due punte è zigrinata per evitare che il filo scivoli.

● 0.30 mm to 0.50 mm (.012" to .020")
■ Max. 0.46 mm x 0.56 mm (.018" x .022")



DO.705.300
Tweed / Pinza di Tweed
Loop forming pliers
Pinza per formare le anse



Instruments for "Fixed Appliance Technique" Strumenti per Ortodonzia Fissa



DO.712.300
Tweed
Loop forming pliers
Pinza per formare le anse

● Max. 0.36 mm to 0.64 mm (.014" to .025")
■ Max. 0.53 mm x 0.64 mm (.021" x .025")



DO.700.200
Omega
Loop forming pliers with replaceable 440 stainless steel tip, three step tip has 1.14, 1.52 and 1.91mm diameters
Pinza per formare anse
Con una punta in acciaio inox 440 intercambiabile con diametri scalari di 1,14, 1,52 e 1,91 mm

● Max. 0.36 mm to 0.64 mm (.014" to .025")
■ Max. 0.53 mm x 0.64 mm (.021" x .025")



DO.710.200
Tweed
Loop forming pliers with replaceable 440 stainless steel tip, three step tip has 1.14, 1.52 and 1.91mm diameters
Pinza per formare anse
Con una punta in acciaio inox 440 intercambiabile con diametri scalari di 1,14, 1,52 e 1,91 mm

● Max. 0.36 mm to 0.64 mm (.014" to .025")
■ Max. 0.53 mm x 0.64 mm (.021" x .025")



DO.700.010
Replacement tip stainless steel 440 for Omega or Tweed loop forming pliers. Tip diameters 1.14mm, 1.52 and 1.91mm
Punta di ricambio in acciaio inox 440 con diametri scalari di 1,14, 1,52 e 1,91mm per formare anse di Omega o Tweed

Slim-line
Pliers

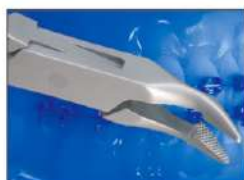

DO.738.500
Weingart
Slim and sleek design with long handles for better access to the posterior area, also suitable for lingual technique.
Modello con punte fini e affusolate e manici lunghi per facilitare l'accesso in zone posteriori della bocca. Anche adatte per la tecnica linguale.

● Max. 0.30 mm to 0.50 mm (.012" to .020")
■ Max. 0.56 mm x 0.71 mm (.022" x .028")

Utility pliers / Pinza di utilità



Multipurpose pliers, useful for placement and removal of archwires and auxiliaries. Tips are serrated to securely hold wire and tapered thus fits between brackets. The jaws are bowed and contact only at tips to prevent lip pinching. Box joint design for stability.

Pinza multiuso ideale per posizionare e rimuovere archi e ausiliari. Le punte sono zigrinate e affusolate per trattenere il filo e inserirsi tra gli attacchi. Il contatto avviene solo in punta per evitare di pizzicare le labbra. Snodo costruito per assicurare massima stabilità.

Falcon with tungsten carbide inserts
con inserti al carburo di tungsteno



● Max. 0.30 mm to 0.50 mm (.012" to .020")
■ Max. 0.56 mm x 0.71 mm (.022" x .028")



● Max. 0.30 mm to 0.50 mm (.012" to .020")
■ Max. 0.56 mm x 0.71 mm (.022" x .028")

DO.735.100
Weingart Mini
Slim design for better accessibility in posterior and lingual areas
Forma snella per facilitare l'accessibilità nelle zone posteriori e linguali.

DO.738.100
Weingart



DO.735.300
Weingart Mini
Slim design for better accessibility in posterior and lingual areas
Forma snella per facilitare l'accessibilità nelle zone posteriori e linguali.



DO.736.300
Weingart Narrow
Narrow long tips for better access to hard to reach areas
Punte strette e sottili per facilitare l'impiego in zone di difficile accesso



● Max. 0.30 mm to 0.50 mm (.012" to .020")
■ Max. 0.56 mm x 0.71 mm (.022" x .028")

DO.738.300
Weingart

soft. grippliers

Fatigue Free
2 years warranty

Senza sforzo
2 anni di garanzia





Instruments for "Fixed Appliance Technique" Strumenti per Ortodonzia Fissa



soft.
grip pliers



Mini head distal end cutter with safety hold, long handles

Fitted with un-breakable, corrosion resistant and durable stainless steel tips

Mini tronchesino distale con trattenuta del filo, testa piccola, manici lunghi

Muniti di riporti in acciaio duro inox anti-rottura resistenti alla corrosione



DO.542.750
Falcon

●	0.30 mm to 0.50 mm (.012" to .020")
■	Max. 0.46 mm x 0.64 mm (.018" x .025")
⊙	0.38 mm to 0.53 mm (.0155" to .0215")
⊞	Max. 0.53 mm x 0.64 mm (.021" x .025")

Hard wire cutter, 15° angled

Fitted with un-breakable, corrosion resistant and durable stainless steel tips

Tronchesino per fili duri con angolo di 15°

Muniti di riporti in acciaio duro inox anti-rottura resistenti alla corrosione



DO.555.750
Falcon

●	0.30 mm to 0.50 mm (.012" to .020")
■	Max. 0.56 mm x 0.71 mm (.022" x .028")

Soft wire and ligature cutter, Mini

Fitted with un-breakable, corrosion resistant and durable stainless steel tips

Mini tronchesino per legature e fili teneri

Muniti di riporti in acciaio duro inox anti-rottura resistenti alla corrosione



DO.572.750
Falcon

⌋	.25 mm to .38 mm (.010" to .015")
---	-----------------------------------

Band removing pliers

Pinza per la rimozione di bande



DO.492.750
Falcon

Bracket removing pliers with plastic tip

Pinza con guarnizione in plastica per rimuovere gli attacchi



DO.520.750
Falcon

Utility pliers

Pinza di Utilità



DO.738.750
Weingart

●	0.30 mm to 0.50 mm (.012" to .020")
■	Max. 0.56 mm x 0.71 mm (.022" x .028")



Instruments for "Fixed Appliance Technique" Strumenti per Ortodonzia Fissa



Standard distal end cutter with safety hold

Fitted with un-breakable, corrosion resistant and durable stainless steel tips

Tronchesino distale standard con trattenuta del filo

Muniti di riporti in acciaio duro inox anti-rottura resistenti alla corrosione



DO.535.700

Falcon

- 0.30 mm to 0.50 mm (.012" to .020")
- Max. 0.56 mm x 0.71 mm (.022" x .028")

Soft wire and ligature cutter, Mini

Fitted with un-breakable, corrosion resistant and durable Stainless steel tips

Mini tronchesino per legature e fili teneri

Muniti di riporti in acciaio duro inox anti-rottura resistenti alla corrosione



DO.572.700

Falcon

- ☞ 25 mm to 38 mm (.010" to .015")

Mini head distal end cutter with safety hold

Fitted with un-breakable, corrosion resistant and durable Stainless steel tips

Mini tronchesino distale con trattenuta del filo, testa piccola

Muniti di riporti in acciaio duro inox anti-rottura resistenti alla corrosione



DO.536.700

Falcon

- 0.30 mm to 0.50 mm (.012" to .020")
- Max. 0.46 mm x 0.64 mm (.018" x .025")
- ⊗ 0.38 mm to 0.53 mm (.0155" to .0215")
- ⊠ Max. 0.53 mm x 0.64 mm (.021" x .025")

Soft wire and ligature cutter, standard

Fitted with un-breakable, corrosion resistant and durable stainless steel tips

Standard tronchesino per legature e fili teneri

Muniti di riporti in acciaio duro inox anti-rottura resistenti alla corrosione



DO.574.700

Falcon

- ☞ 25 mm to 38 mm (.010" to .015")

Distal end cutter with safety hold, mini head, long handles

Fitted with un-breakable, corrosion resistant and durable stainless steel tips

Mini tronchesino distale con trattenuta del filo, testa piccola, manici lunghi

Muniti di riporti in acciaio duro inox anti-rottura resistenti alla corrosione



DO.542.700

Falcon

- 0.30 mm to 0.50 mm (.012" to .020")
- Max. 0.46 mm x 0.64 mm (.018" x .025")
- ⊗ 0.38 mm to 0.53 mm (.0155" to .0215")
- ⊠ Max. 0.53 mm x 0.64 mm (.021" x .025")

Soft wire and ligature cutter, 15° angled

Fitted with un-breakable, corrosion resistant and durable stainless steel tips

Mini tronchesino per legature e fili teneri con angolo di 15°

Muniti di riporti in acciaio duro inox anti-rottura resistenti alla corrosione



DO.575.700

Falcon

- ☞ 25 mm to 38 mm (.010" to .015")

Flush-cut distal end cutter with safety hold

Fitted with un-breakable, corrosion resistant and durable stainless steel tips

Tronchesino distale con trattenuta del filo

Muniti di riporti in acciaio duro inox anti-rottura resistenti alla corrosione



DO.545.700

Falcon

- 0.30 mm to 0.50 mm (.012" to .020")
- Max. 0.46 mm x 0.64 mm (.018" x .025")

Soft wire and ligature cutter, 45° angled

Fitted with un-breakable, corrosion resistant and durable stainless steel tips

Mini tronchesino per legature e fili teneri con angolo di 45°

Muniti di riporti in acciaio duro inox anti-rottura resistenti alla corrosione



DO.578.700

Falcon

- ☞ 25 mm to 38 mm (.010" to .015")



Instruments for "Fixed Appliance Technique" Strumenti per Ortodonzia Fissa

Hard wire cutter, straight

Fitted with un-breakable, corrosion resistant and durable stainless steel tips

Tronchesino dritto per fili duri

Muniti di riporti in acciaio duro inox anti-rottura resistenti alla corrosione



DO.550.700
Falcon

● 0.30 mm to 0.50 mm (.012" to .020")
■ Max. 0.56 mm x 0.71 mm (.022" x .028")

Hard wire cutter, 15° angled

Non-autoclavabile

Tronchesino per fili duri con angolo di 15°

Non-autoclavabile



DO.550.400
Falcon

● 0.30 mm to 0.50 mm (.012" to .020")
■ Max. 0.56 mm x 0.71 mm (.022" x .028")

Hard wire cutter, 15° angled

Fitted with un-breakable, corrosion resistant and durable stainless steel tips

Tronchesino per fili duri con angolo di 15°

Muniti di riporti in acciaio duro inox anti-rottura resistenti alla corrosione



DO.555.700
Falcon

● 0.30 mm to 0.50 mm (.012" to .020")
■ Max. 0.56 mm x 0.71 mm (.022" x .028")

Band removing pliers

Pinza per la rimozione di bande



DO.492.700
Falcon

Bracket removing pliers angled

Pinza ad angolo per la rimozione di attacchi



DO.510.700
Falcon

Bracket removing pliers straight

Pinza dritto per la rimozione di attacchi



DO.511.700
Falcon

Bracket removing pliers with plastic tip

Pinza con guarnizione in plastica per rimuovere gli attacchi



DO.520.700
Falcon

Adhesive removing pliers

Pinza per rimuovere residui di adesivo



DO.525.700
Falcon

DO.525.010

Replacement metal tip
Punta metallica di ricambio



Instruments for "Fixed Appliance Technique" Strumenti per Ortodonzia Fissa



Utility pliers
Pinze di utilità



DO.735.700
Weingart-Mini

● 0.30 mm to 0.50 mm (.012" to .020")
■ Max. 0.56 mm x 0.71 mm (.022" x .028")



DO.738.700
Weingart

● 0.30 mm to 0.50 mm (.012" to .020")
■ Max. 0.56 mm x 0.71 mm (.022" x .028")

Utility pliers
Pinze di utilità



DO.664.700
How
Straight / Dritta

● 0.30 mm to 0.50 mm (.012" to .020")
■ Max. 0.56 mm x 0.71 mm (.022" x .028")



DO.665.700
Angled / Ad angolo

● 0.30 mm to 0.50 mm (.012" to .020")
■ Max. 0.56 mm x 0.71 mm (.022" x .028")

Wire bending and loop forming pliers
Pinza per piegare e formare anse con fili



DO.592.700
Angel (Bird beak)

● 0.30 mm to 0.50 mm (.012" to .020")
■ Max. 0.56 mm x 0.71 mm (.022" x .028")

Light wire bending and loop forming pliers
Pinza per piegare e formare anse con fili fini



DO.610.700
Falcon

● 0.30 mm to 0.50 mm (.012" to .020")
■ Max. 0.41 mm x 0.56 mm (.016" x .022")

Light wire bending pliers with cutter
Fitted with hard metal tips
Pinze per piegare fili teneri con tronchesino
Munita di riporti in acciaio duro



DO.608.700
Falcon

● 0.30 mm to 0.50 mm (.012" to .020")
■ Max. 0.46 mm x 0.56 mm (.018" x .022")

Light wire bending and loop forming pliers with cutter
Pinza per piegare e formare anse con tronchesino



DO.609.700
Falcon

● 0.30 mm to 0.50 mm (.012" to .020")
■ Max. 0.46 mm x 0.56 mm (.018" x .022")

Light wire bending and loop forming pliers, grooved tip
Pinza per piegare e formare anse con fili fini



DO.705.700
Tweed

● 0.30 mm to 0.50 mm (.012" to .020")
■ Max. 0.46 mm x 0.56 mm (.018" x .022")



Instruments for "Fixed Appliance Technique" Strumenti per Ortodonzia Fissa

Loop forming pliers with cutter
Pinza per formare anse con tronchesino



DO.711.700
Tweed

● 0.30 mm to 0.50 mm (.012" to .020")
■ Max. 0.53 mm x 0.64 mm (.021" x .025")

Light wire bending pliers
Pinza per piegare fili fini



DO.675.700
Jarabak

● 0.30 mm to 0.50 mm (.012" to .020")
■ Max. 0.46 mm x 0.56 mm (.018" x .022")

3-jaw wire bending pliers
Pinza con tre punte per piegare.



DO.585.700
Aderer

● 0.30 mm to 0.50 mm (.012" to .020")
■ Max. 0.56 mm x 0.71 mm (.022" x .028")

Ligature forming pliers
Pinza per formare legature



DO.580.700
Falcon

25 mm to 38 mm (.010" to .015")

Archwire forming pliers, concave and convex tips
Pinza concava convessa per formare archi



DO.613.700
Hollow-Chop

● 0.30 mm to 0.71 mm (.012" to .028")
■ Max. 0.56 mm x 0.71 mm (.022" x .028")

Multi-purpose pliers, bird beak, De la rosa and cutter in one
Pinze universali a becco d'uccello De la Rosa con tronchesino



DO.598.700
Falcon

● 0.30 mm to 0.50 mm (.012" to .020")
■ Max. 0.46 mm x 0.56 mm (.018" x .022")

Distal end bending pliers
Tronchesino per ripiegature distali



DO.623.700
Falcon (Cinch back/ tie back)

● 0.30 mm to 0.50 mm (.012" to .020")
■ Max. 0.56 mm x 0.71 mm (.022" x .028")

Distal end bending pliers
Tronchesino per ripiegature distali



DO.624.700
Falcon (Hammer head)

● 0.30 mm to 0.50 mm (.012" to .020")
■ Max. 0.56 mm x 0.71 mm (.022" x .028")





Instruments for "Fixed Appliance Technique" Strumenti per Ortodonzia Fissa



Loop forming pliers
Pinza per formare le anse



DO.688.700
Nance

● 0.36 mm to 0.71 mm (.014" to .028")
■ Max. 0.56 mm x 0.71 mm (.022" x .028")

Detailing step pliers / Bayonet bending pliers - 1mm
Pinze per piegatura a Baionetta -1mm



DO.630.700
Falcon

● 0.30 mm to 0.50 mm (.012" to .020")
■ Max. 0.56 mm x 0.71 mm (.022" x .028")

Stop pliers V-Bend - 1mm
Pinze per piegatura a V dei fili -1mm



DO.655.700
Falcon

● 0.30 mm to 0.50 mm (.012" to .020")
■ Max. 0.43 mm x 0.56 mm (.017" x .022")

Lingual / palatal arch forming pliers
Pinza per formare archi linguales e palatali



DO.618.700
Falcon

● 0.76 mm (.030") / 0.91 mm (.036")

Torquing pliers set
Kit pinze per torquing



.018" .022"

DO.641.700
Falcon

Rectangular arch forming and torquing pliers
Pinze per torquing e per formare archi rettangolari



DO.713.700
Tweed / angel

● 0.30 mm to 0.71 mm (.012" to .028")
■ Max. 0.56 mm x 0.71 mm (.022" x .028")

Surgical ball hook crimping pliers, angled
Pinza per grippare ganci chirurgici e stop, ad angolo



DO.620.700
Falcon

Surgical ball hook crimping pliers, straight
Pinza per grippare ganci chirurgici e stop, dritta



DO.621.700
Falcon



Instruments for "Removable Appliance Technique"
Strumenti per Ortodonzia Mobile



Falcon
Hard wire cutters
 With durable hard metal inserts, stainless steel, autoclavable



DO.777.100
 Side cutter
 Tronchesino per tagli laterali
 ● 0.70 mm to 1.00 mm (.028" to .040")

Tronchesini per fili duri
 in acciaio inox con riporti in acciaio extra duro, autoclavabili



DO.779.100
 End cutter
 Tronchesino per tagli frontali
 ● 0.70 mm to 1.00 mm (.028" to .040")



DO.777.300
 Side cutter
 Tronchesino per tagli laterali
 ● 0.60 mm to 0.80 mm (.024" to .032")

Falcon
Hard wire cutters
 Stainless steel, autoclavable
Tronchesini per fili duri
 In acciaio inox, autoclavabili



DO.779.300
 End Cutter
 Tronchesino per tagli frontali
 ● 0.60 mm to 0.80 mm (.024" to .032")



DO.785.300
 Small / Piccola
 Stainless steel, autoclavable
 Acciaio Inox, autoclavabile
 ● 0.87 mm to 1.1 mm (.028" to .045")

Falcon
Heavy duty hard wire cutters
 Compound action
 Cut heavy wires with little force
Tronchesini per fili duri ad elevata resistenza
 Grazie alle leve
 taglia con poca forza anche fili grossi



DO.787.300
 Small / Piccola
 Stainless Steel, autoclavable
 Acciaio Inox, autoclavabile
 ● 0.87 mm to 1.1 mm (.028" to .045")



DO.786.300
 Large / Grande
 Stainless steel, autoclavable
 Acciaio inox, autoclavabile
 ● 0.80 mm to 1.50 mm (.032" to .057")

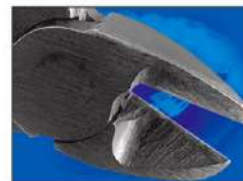

DO.786.400
 Large / Grande
 Carbon steel, non autoclavable
 Ghisa, non autoclavabili
 ● 0.80 mm to 1.50 mm (.032" to .057")



Instruments for "Removable Appliance Technique" Strumenti per Ortodonzia Mobile



Adams wire bending pliers
Tips of all Adams pliers parallel at 1mm opening
box joint, available in mini and maxi sizes

Pinze di Adams per piegare
Tutte le pinze di Adams hanno lo snodo a incastro sono disponibili nei
formati mini e maxi e hanno le punte parallele con apertura 1 mm.



Adams pliers with tungsten carbide tips
Pinze di Adams con riporti al carburo di tungsteno



DO.796.100
Adams Maxi Fig. 64

● 0.36 mm to 0.81 mm (.014" to .032")
■ Max. 0.56 mm x 0.71 mm (.022" x .028")



DO.799.100
Adams Maxi Fig. 65

● 0.36 mm to 0.81 mm (.014" to .032")
■ Max. 0.56 mm x 0.71 mm (.022" x .028")

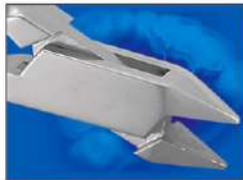
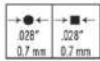

DO.795.300
Adams Mini

● 0.36 mm to 0.71 mm (.014" to .028")
■ Max. 0.56 mm x 0.71 mm (.022" x .028")



DO.798.300
Adams Mini

● 0.36 mm to 0.71 mm (.014" to .028")
■ Max. 0.56 mm x 0.71 mm (.022" x .028")



DO.796.300
Adams Maxi Fig. 64

● 0.36 mm to 0.81 mm (.014" to .032")
■ Max. 0.56 mm x 0.71 mm (.022" x .028")

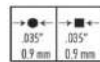

DO.799.300
Adams Maxi Fig. 65

● 0.36 mm to 0.81 mm (.014" to .032")
■ Max. 0.56 mm x 0.71 mm (.022" x .028")



Instruments for "Removable Appliance Technique" Strumenti per Ortodonzia Mobile

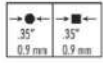

DO.812.300
Angel
Bird beak lab. pliers
Tips parallel at 1mm opening
Pinza da laboratorio con punte a becco d'uccello. Le punte sono parallele con apertura 1 mm

● 0.36 mm to 0.71 mm (.014" to .028")
■ Max. 0.56 mm x 0.71 mm (.022" x .028")



DO.830.300
Falcon
Flat nose wire bending pliers
Pinza per piegare con punte piatte

● 0.36 mm to 0.71 mm (.014" to .028")
■ Max. 0.56 mm x 0.71 mm (.022" x .028")

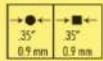

DO.813.300
Angel
Round nose wire bending and loop forming pliers
Pinze per piegare e formare anse con punte tonde

● 0.36 mm to 0.71 mm (.014" to .028")
■ Max. 0.56 mm x 0.71 mm (.022" x .028")



DO.835.300
Falcon
Round nose wire bending and loop forming pliers
Pinze per piegare e formare anse con punte tonde

● 0.36 mm to 0.71 mm (.014" to .028")
■ Max. 0.56 mm x 0.71 mm (.022" x .028")



DO.860.300
Peeso
Round nose wire bending pliers
Pinza per piegare con punte tonde

● 0.36 mm to 0.71 mm (.014" to .028")
■ Max. 0.56 mm x 0.71 mm (.022" x .028")

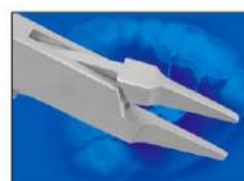

DO.861.300
Peeso
Crown and collar contouring pliers
Pinze per bande di corone



Aderer 3-Jaw wire bending pliers
Precision aligned and contoured tips for consistent bends without damaging wire.
Pinza di Aderer a tre punte per piegare
La precisione e rifinitura delle punte consente di riprodurre pieghe uguali tra loro senza danneggiare il filo



DO.806.300
Aderer - Mini

● 0.36 mm to 0.50 mm (.014" to .020")
■ Max. 0.53 mm x 0.64 mm (.021" x .025")



DO.807.300
Aderer - Midi

● 0.36 mm to 0.71 mm (.014" to .028")
■ Max. 0.56 mm x 0.71 mm (.022" x .028")



DO.808.300
Aderer - Maxi

● 0.50 mm to 0.91 mm (.020" to .036")
■ Max. 0.56 mm x 0.71 mm (.022" x .028")



DO.870.300
Schwarz Mini
Optical style, round and concave beaks.
Loop forming pliers
Pinza stile ottico per formare le anse con punta tonda/concava

● Max. 0.50 mm (.020")

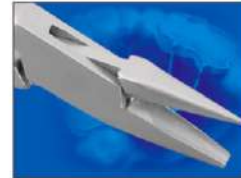

DO.871.300
Schwarz Midi
Optical style, round and concave beaks.
Loop forming pliers
Pinza stile ottico per formare le anse con punta tonda/concava

● Max. 0.70 mm (.028")



DO.872.300
Schwarz Maxi
Optical style, round and concave beaks.
Loop forming pliers
Pinza stile ottico per formare le anse con punta tonda/concava

● Max. 0.70 mm (.028")



Instruments for "Removable Appliance Technique" Strumenti per Ortodonzia Mobile



● Max. 0.70 mm (.028")

DO.874.300

Schwarz graduated
Optical style, round and concave beaks.
Loop forming pliers. Graduation prevents
wire slippage
Pinza stile ottico per formare le anse con
punte tonda/concava. Le tacche
prevengono lo scorrimento del filo.



● Max. 0.80 mm (.032")

DO.850.300

Mckellops
Optical style, round and concave beaks.
Heavy loop forming pliers
Pinza stile ottico per formare anse grosse
con punte tonda/concava



● 0.36 mm to 0.71 mm (.014" to .028")

■ Max. 0.56 mm x 0.71 mm (.022" x .028")



DO.896.300

Young
Loop forming pliers
Pinza per formare le anse

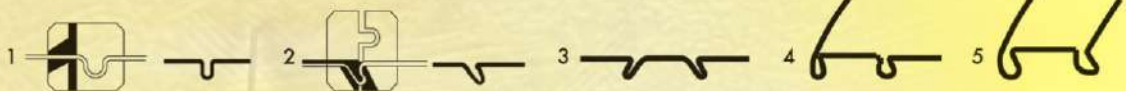

Max. 0.70 mm (.028")



DO.845.100

Nance
Adams clasp forming pliers
Pinza per formare ganci di Adams



Max. 0.70 mm (.028")



DO.877.300

Schwarz
Arrow clasp forming pliers
Pinza per formare ganci a freccia



Max. 0.70 mm (.028")



DO.876.300

Schwarz
Arrow clasp bending pliers
Pinza per piegare ganci a freccia



● Bends/Piega: 0.9 mm (.036")
Cuts/Taglia: 0.7 mm (.028")



DO.884.300
Universal Mini - Dolphin style
Wire bending and cutting pliers
Mini Dolphin universale
Pinza per piegare e tagliare

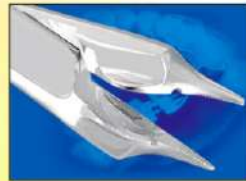

● Bends/Piega: 0.9 mm (.036")
Cuts/Taglia: 0.7 mm (.028")



DO.885.300
Universal - Dolphin style
Wire bending and cutting pliers
Dolphin universale
Pinza per piegare e tagliare



● Bends/Piega: 0.9 mm (.036")
Cuts/Taglia: 0.7 mm (.028")



DO.886.300
Universal - Taper style
Wire bending and cutting pliers
Universale a punta coniche
Pinza per piegare e tagliare



● Bends/Piega: 0.9 mm (.036")
Cuts/Taglia: 0.7 mm (.028")



DO.895.300
Waldsachs
Wire bending and cutting pliers
Pinza per piegare e tagliare



Instruments for "Removable Appliance Technique"
Strumenti per Ortodonzia Mobile



Max. 1.60 mm (.063")



DO.810.300
Aderer
Facebow loop forming pliers
 For forming loops in either
 inner or outer bows of facebow
Pinza per formare anse
 sugli archi extraorali
 Per formare anse sugli
 archi interni ed esterni



Max. 1.80 mm (.071")



DO.888.300
Universal
Parallel jaw pliers with side cutter, compound action
 Powerful pliers easily cuts outer bow
 of a facebow, serrated jaws assure
 non-slip grip while bending
Pinza con punte parallele e tronchesino incorporato robusta per facilitare il
taglio degli archi interni ed esterni
 Le punte zigrinate evitano lo
 scivolamento del filo durante la piegatura



Max. 1.80 mm (.071")



DO.892.300
Magnum
Universal facebow loop forming and cutting pliers
 Heavy duty pliers easily bends or
 cuts outer or inner bow of a facebow
Pinza universale per formare e tagliare anse
 Robusta pinza per piegare con
 facilità archi interni ed esterni



Lips and cheek retractors / Divaricatori per labbra e guance



Lips / Labbra



Tongue / Lingua



Lateral / Laterale

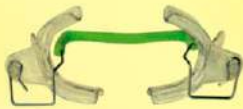

DS.424.010
 Universal set / Abbassalingua universale
 Contents / Contenuto:
 2 x adult and child springs / 2 x molle per adulto e bambino
 4 x cheek retractors / 4 x divaricatori

DS.424.020
 Universal set / Abbassalingua universale
 Contents / Contenuto:
 2 x adult and child springs / 2 x molle per adulto e bambino
 4 x cheek retractors / 4 x divaricatori



DS.423.010
 Small / Piccolo

DS.423.030
 Large / Grande



Falcon
DS.425.010
 Small / Piccolo

DS.425.030
 Large / Grande



Transparent / Trasparente
DS.425.040 Small / Piccolo
DS.425.050 Medium / Medio
DS.425.060 Large / Grande



DS.435.020
 Simplex-Falcon

ORTHO - TRAYS

Orthodontic impression trays perforated / Portaimpronte ortodontiche perforate



Lower
 Inferiori



No	Size	Code/Codice	A mm	B mm	C mm
L3	S	DI.151.030	70	55	18
L4	M	DI.151.040	77	60	21
L5	L	DI.151.050	82	62	22



DI.156.006
 Set of 6 pieces / Serie di 6 pezzi
 Contents / Contenuto
 U1,U2,U3, L1,L2,L3



Upper
 Superiori



No	Size	Code/Codice	A mm	B mm	C mm
U3	S	DI.156.030	67	55	18
U4	M	DI.156.040	73	60	21
U5	L	DI.156.050	76	62	22

Retainer Cases Classic Midi
Orthobox Classico Midi



Retainer cases classic midi
 Orthobox classico midi

Color / Colori	
Assorted / assortiti	DO.6320.00
Black / Nero	DO.6320.01
Blue Dark / Blu	DO.6320.02
Blue Light / Celeste	DO.6320.03
Green Fluorescent / Verde Fluorescente	DO.6320.04
Orange / Arancione	DO.6320.05
Pink Hot / Rosa	DO.6320.06
Purple / Porpora	DO.6320.07
Red / Rosso	DO.6320.08
Violet / Viola	DO.6320.10
Yellow / Giallo	DO.6320.11
Pack of 10 pieces / Conf. 10 pezzi	



Retainer cases classic midi with mirror
 Orthobox classico midi con specchietto

Color / Colori	
Assorted / assortiti	DO.6350.00
Black / Nero	DO.6350.01
Blue Dark / Blu	DO.6350.02
Blue Light / Celeste	DO.6350.03
Green Fluorescent / Verde Fluorescente	DO.6350.04
Orange / Arancione	DO.6350.05
Pink Hot / Rosa	DO.6350.06
Purple / Porpora	DO.6350.07
Red / Rosso	DO.6350.08
Violet / Viola	DO.6350.10
Yellow / Giallo	DO.6350.11
Pack of 10 pieces / Conf. 10 pezzi	





Pliers stands / Porta pinze



DO.965.010
Black / Nero
DO.965.020
Blue / Blu
DO.965.040
Clear / Trasparente
DO.965.080
White / Bianco



Pliers stand / Porta pinze

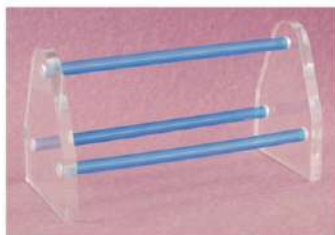

DO.964.010

Pliers stand autoclavable
Supporto autoclavabile per pinze



DO.963.010
Mini
95 x 125 mm



DO.963.020
Midi
110 x 125 mm



DO.963.030
Maxi
155 x 125 mm



DO.963.040
X-Large
310 x 125 mm

Silicone grips for orthodontic pliers
Rivestimento per pinze ortodonzia in silicone alto grip

Comfortable
Non slip
Reduce hand fatigue
Easy to put on and off

Pratico
Alto grip
Riduce la fatica della mano
Facile da applicare/togliere



DO.950.010
White, pair
Bianco, paio

Foam grips for laboratory pliers
Rivestimento per pinze da laboratorio in schiuma, alto grip



Foam grips are ideal for technicians working long hours, they reduce hand fatigue and make working a pleasure, these also prevent damage to finger rings of user non-autoclavable

I rivestimenti in schiuma sono ideali per l'odontotecnico che lavora a lungo: riducono la fatica e rendono il lavoro piacevole. Inoltre evitano danni alla pelle o ad anelli non-autoclavabile



DO.952.010
Black / Nero



DO.952.020
Dark Blue / Blu scuro



DO.952.030
Light Blue / Celeste



DO.952.040
Green / Verde



DO.952.050
Pink / Rosa



DO.952.060
Purple / Porpora



DO.952.070
Red / Rosso



DO.952.080
Green-Black / Verde-Nero



DO.952.090
Red-Black / Rosso-Nero



DO.952.100
White-Black / Bianco-Nero



Covered pliers rack
Supporto per pinze con coperchio



DO.966.000

Disposable bonding trays organizer
Porta vassoi monouso per bonding



DO.1990.00

Instruments organizer
Organizer per strumenti



DO.966.020

Elastomeric ligature sticks organizer
Organizer per legature elastiche in sticks

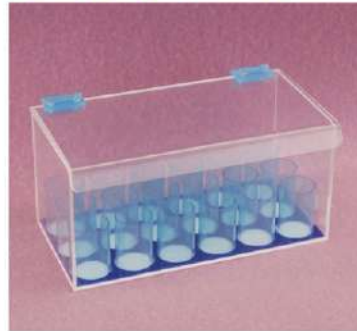

DO.5980.01

Instruments organizer round
Organizer per strumenti tondo



DO.966.030

Elastomeric chains organizer
Organizer per catenelle elastiche



DO.5981.02

Archwires organizer
Organizer per archi

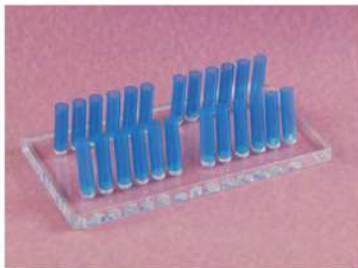

DO.5390.01

Combination organizer for elastomeric ligature sticks and chains
Organizer per legature elastiche in sticks e catenelle elastiche



DO.5982.01

Archwires organizer with cover
Organizer per archi con coperchio

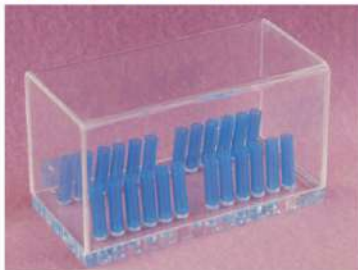

DO.5390.00

Relief wax organizer
Organizer per cera ortodontica



DO.6220.00

Teaching Aids / Ausili didattici



Real-Series **Dental Models**

Dental models ideal occlusion, adult jaw

- Rigid bases - 32 fixed teeth - Articulated
- Available with transparent or pink bases, life or big size
- Advantage in transparent models is visibility of roots

Modelli dentali - occlusione ideale - adulti

- Basi rigide articolate - Denti fissi
- Disponibili in colore trasparente o rosa, dimensione normale o maxi
- I modelli trasparenti consentono di vedere le radici

Life size / Dimensione normale



Big size / Dimensione maxi



Transparent / Trasparente

Models are shown 1/1 - I modelli sono in scala 1/1

Fig.	Size / Misura	Code / Codice
RV-006	Life size / Dimensione normale	DT.1201.01
RV-001	Big size / Dimensione maxi	DT.1201.02

Two Tones, pink bases / Basi rosa di due tonalità

Fig.	Size / Misura	Code / Codice
RV-007	Life size / Dimensione normale	DT.1200.01
RV-002	Big size / Dimensione maxi	DT.1200.02

Dental models ideal occlusion, adult jaw ramified / Modelli dentali - occlusione ideale - ramificati

Big size / Dimensione maxi



Fig. RV-009

- Detailed model to explain different diseases and treatments
- Rigid bases - 32 fixed teeth - Articulated
- Shows caries (decayed teeth are removable)
- Shows healthy and decayed pulp canal
- Fitted with implant and crown

- Modello dettagliato per spiegare le diverse patologie e trattamenti
- Basi rigide articolate - 32 denti fissi
- Mostra le carie (denti cariati rimovibili)
- Mostra canali pulpari sani e deperiti
- Completo di impianto e corona

Life size / Dimensione normale



Fig. RV-008

Transparent / Trasparente

Fig.	Size / Misura	Code / Codice
RV-008	Life size / Dimensione normale	DT.1205.01
RV-009	Big size / Dimensione maxi	DT.1205.02

Real-Series Dental Models

Caries evolution model
Set of 4 teeth to demonstrate tooth decay

Modello 'evoluzione carie'
Serie di 4 denti con diverse carie dentali



Fig. RV-003 DT.1220.00 Set of 4 teeth with holder / Set di 4 denti con supporto

Periodontal disease evolution model
Set of 4 models to demonstrate spread of periodontal disease

Modello 'evoluzione patologie dentali'
Serie di 4 modelli con varie patologie parodontali



Fig. RV-004 DT.1225.00 Set of 4 models / Serie di 4 modelli

Dental model ideal occlusion, adult jaw

- Flexible bases - 32 teeth with roots - Non-articulated
- Versatile model to demonstrate many dental treatment techniques
- Removable teeth allow fitting of different dental appliances e.g implants, crowns
- Allows demonstration of extraction instruments and practice of extraction techniques
- Superior alternative to wax base models

Modello dentale - occlusione ideale - adulti

- Basi flessibili - 32 denti con radici - Non articolato
- Modello versatile per dimostrare i vari trattamenti dentali
- I denti amovibili consentono l'uso di impianti, corone, ecc.
- Consente di dimostrare gli strumenti e le tecniche di estrazione
- Migliore alternativa rispetto ai modelli con basi in cera



Fig. RV-010 DT.1210.00 Set of 2, upper and lower / Serie di 2 - superiore e inferiore

Real-Series Endodontic Models

Endodontic practice model

- With canal cavities in FDI 11 to 16 and 41 to 46, indicated by silver lines on model
- Very useful model for practicing use of root canal instruments
- Flexible bases - 32 fixed teeth with roots - Articulated

Modello didattico per endodonzia.

- Con cavità canalari in FDI da 11 A 16 E DA 41 A 46 evidenziati dalle linee in argento
- Modello molto utile per simulare l'uso di strumenti canalari
- Basi flessibili articolate - 32 denti fissi con radici

Demonstration Model - Ramified

- Detailed model to explain Endodontic problems and treatments
- Shows caries (decayed teeth are removable)
- Shows healthy and decayed pulp canal
- Flexible bases - 32 fixed teeth with roots - Articulated

Modello didattico - ramificato

- Modello dettagliato per illustrare problemi e trattamenti endodontici
- Mostra le carie (denti cariati amovibili)
- Mostra canali pulpari sani e deperiti
- Basi flessibili - 32 denti fissi con radici - articolato



Fig. RE-110 DT.1250.00



Fig. RE-111 DT.1251.00

Real-Series

Surgery Models

Surgery model ideal occlusion, adult jaw

- Complete Maxilla and Mandible bone structure with sinus cavity
- Moveable and removable mandible
- Rigid bases - 32 fixed teeth - Articulated with stand

Modello per chirurgia - occlusione ideale - adulti

- Completo di struttura ossea maxillo-facciale con cavità del seno mascellare
- Mandibola mobile amovibile
- Basi rigide - 32 denti fissi - articolato su supporto



Fig. RC-251
DT.1275.00

Skull model, adult size

- Removable cranial cap
- Moveable and removable mandible

Modello di cranio adulto

- Calotta cranica amovibile
- Mandibola mobile amovibile



Fig. RC-252
DT.1285.00

Surgery model ideal occlusion, adult jaw ramified / Modello per chirurgia - occlusione ideale - ramificato - adulti

- Complete Maxilla and Mandible bone structure with sinus cavity
- Detailed model to explain different diseases and treatments
- Moveable and removable mandible
- Rigid bases - 32 fixed teeth - Articulated with stand
- Shows caries (decayed teeth are removable)
- Shows healthy and decayed pulp canal

- Completo di struttura ossea maxillo-facciale con cavità del seno mascellare
- Modello dettagliato per la didattica su patologie e trattamenti
- Mandibola mobile amovibile
- Basi rigide - 32 denti fissi - articolato su supporto
- Mostra le carie (denti cariati amovibili)
- Mostra canali pulpari sani e deperiti



Fig. RC-250
DT.1276.00

Real-Series

Orthodontic Models

Rigid bases - 28 fixed teeth - Articulated
Available in transparent or pink bases

Basi rigide articolate - Dentii fissi
Disponibili in colore trasparente o rosa

Class I - Ideal arch / Classe I - Arcata ideale



Fig. RO-040

DT.1305.01 Transparent / Trasparente

Class I - Ideal arch / Classe I - Arcata ideale



Fig. RO-048

DT.1300.01 Two Tones, pink bases / Basi con due tonalità di rosa

Class I - 'Angle' / Classe I 'Angle'



Fig.	Type / Tipo	Code / Codice
RO-053	Two Tones, pink bases / Basi con due tonalità di rosa	DT.1303.02
RO-045	Transparent / Trasparente	DT.1305.02

Class II Division I / Classe II Divisione I



Fig.	Type / Tipo	Code / Codice
RO-049	Two Tones, pink bases / Basi con due tonalità di rosa	DT.1303.03
RO-041	Transparent / Trasparente	DT.1305.03

Class II Division II / Classe II Divisione II



Fig.	Type / Tipo	Code / Codice
RO-050	Two Tones, pink bases / Basi con due tonalità di rosa	DT.1303.04
RO-042	Transparent / Trasparente	DT.1305.04

Class III / Classe III



Fig.	Type / Tipo	Code / Codice
RO-051	Two Tones, pink bases / Basi con due tonalità di rosa	DT.1303.05
RO-043	Transparent / Trasparente	DT.1305.05

Real-Series

Orthodontic Models

Desk-Top patient education models

- Ideal for the desk of orthodontists, for explanation of treatment to patients
- Fitted with brackets, wires, ligatures and buccal tubes
- Other devices can also be added i.e. temporary implants
- Model with ceramic and metal brackets to demonstrate the difference

Modelli didattici da tavolo

- Ideali per illustrare il trattamento ortodontico previsto
- Completati di brackets, fili, legature e tubetti buccali
- Possibilità di montare altre applicazioni quali impianti temporanei
- Modello con brackets in ceramica e metallo per dimostrare la differenza



- DT. 1320.01 With metal brackets / Con brackets in metallo
 DT. 1320.02 With ceramic and metal brackets / Con brackets in ceramica e metallo

Orthodontic model, Ideal occlusion, Flexible bases

- Removable 28 teeth, Non-articulated
- Versatile model to demonstrate and practice many orthodontic treatment techniques especially temporary orthodontic implants

Modello ortodontico, occlusione ideale, basi flessibili

- 28 denti rimuovibili, non articolato
- Modello versatile per scopi didattici o pratici di molte tecniche ortodontiche in particolare impianti ortodontici temporanei.



- DT.1315.01 Teeth without roots
Denti senza radici
 DT.1315.02 Teeth with roots
Denti con radici

Orthodontic model, Ideal occlusion, Rigid bases

- Removable 28 teeth, Non-articulated

Modello ortodontico, occlusione ideale, basi rigide

- 28 denti rimuovibili, non articolato



- DT.1316.01 Teeth without roots
Denti senza radici
 DT.1316.02 Teeth with roots
Denti con radici

Typodont Articulator

Typodont Articulator is an excellent demonstration and teaching aid. Articulation allows for a magnitude of adjustments to emulate a variety of malocclusions and skeletal discrepancies. Metal or plastic teeth seat in wax bases for simulation using various orthodontic appliances. The teeth movement can be demonstrated by fitting required orthodontic appliances and placing typodont in hot water or oven for 30 to 60 minutes at 60 °C (140 °F).

Articolatore Typodont

Gli articolatori Typodont sono strumenti eccellenti per dimostrazione e didattica. Consentono una molteplicità di aggiustamenti per emulare una varietà di occlusioni imperfette o difetti scheletrici. Sedi in basi di cera per denti in metallo o in plastica per qualsiasi simulazione usando varie applicazioni ortodontiche. Il movimento dei denti può essere simulato applicando il trattamento ortodontico necessario ed esponendo il Typodont ad una temperatura di 60° C. mediante l'uso di acqua calda o forno.



DT.1400.01

Wax bases for typodont / Basi in cera per Typodont



- DT.1401.01 Class I
Pair / Paio Classe I
 DT.1401.02 Class II Division I
Pair / Paio Classe II Divisione I
 DT.1401.03 Class II Division II
Pair / Paio Classe II Divisione II
 DT.1401.04 Class III
Pair / Paio Classe III

Sets of teeth for Typodont / Serie di denti per Typodont

Plastic teeth / Denti in plastica



- DT.1403.02 Set of 28 teeth without roots / Set di 28 denti senza radici
 DT.1403.03 Set of 28 teeth with roots / Set di 28 denti con radici

Metal teeth / Denti in metallo



- DT.1403.01 Set of 28 teeth without roots / Set di 28 denti senza radici

Real-Series Pediatric Models

Series of models show transition from Deciduous to Permanent dentition
Transparent Rigid bases - Fixed teeth with roots - Articulated

Serie di modelli per illustrare la transizione da denti decidui a permanenti
Basi trasparenti articolate - Denti fissi con radici

Pediatric model, Five years old
Deciduous teeth with embryos, Shows healthy pulp canal

Modello pediatrico - dentizione a 5 anni di età
Denti decidui con germi e canali pulpari sani.



Fig. RD-021

DT.1180.01 Transparent / Trasparente

Pediatric model, Seven years old
Mixed dentition, Shows healthy pulp canal

Modello pediatrico - dentizione a 7 anni di età
Dentizione mista - canali pulpari sani



Fig. RD-022

DT.1180.02 Transparent / Trasparente

Pediatric model, Ten years old
Mixed dentition, Shows healthy pulp canal

Modello pediatrico - dentizione a 10 anni di età
Dentizione mista - canali pulpari sani



Fig. RD-023

DT.1180.03 Transparent / Trasparente

Pediatric model, Eleven years old
Permanent dentition

Modello pediatrico - dentizione a 11 anni di età
Dentizione permanente



Fig. RD-024

DT.1180.04 Transparent / Trasparente

Pediatric model, Twelve years old
Permanent dentition with window

Modello pediatrico - dentizione a 12 anni di età
Dentizione permanente con finestra



Fig. RD-025

DT.1180.05 Transparent / Trasparente

Pediatric model, Twelve years old
Permanent dentition without window

Modello pediatrico - dentizione a 12 anni di età
Dentizione permanente senza finestra



Fig. RD-026

DT.1180.06 Transparent / Trasparente

Real-Series

Pediatric Models

Combination model 'Five-Ten'

Deciduous teeth of five years old on right side and of ten years old on left
Teeth with roots - Healthy pulp canals - Rigid bases - Articulated

Modello da 'cinque a dieci anni'

Denti decidui all'età di cinque anni a destra e all'età di dieci a sinistra
Denti con radici - Canali pulpari sani - Basi rigide articolate



Fig. RD-028

DT.1180.08 Transparent / Trasparente

Combination model 'Five-Adult'

Deciduous teeth of five years old on right side and Permanent Dentition on left
Teeth with roots - Healthy pulp canals - Rigid bases - Articulated

Modello da 'cinque anni/adulto'

Denti decidui all'età di cinque anni a destra e dentizione permanente a sinistra
Denti con radici - Canali pulpari sani - basi rigide articolate



Fig. RD-027

DT.1180.07 Transparent / Trasparente

Natural Deciduous Teeth Storage Model

Interesting way to store fallen Deciduous teeth
Teeth can be fitted with glue

Modello per conservare i denti decidui

Metodo inconsueto per la conservazione dei denti decidui
I denti possono essere trattenuti mediante colla.



Fig. RD-029

DT.1185.00 Transparent / Trasparente

Model's display and storage box with cover

Scatola con coperchio per conservare i modelli



DT.9990.01 Empty / Vuota

Big Tooth Brush

for demonstration of brushing technique

Spazzolino maxi

per dimostrare la tecnica d'uso



DT.9995.01 35 cm long / Lungo 35 cm.

Sterilizing & Sundries / Sterilizzazione e Varie

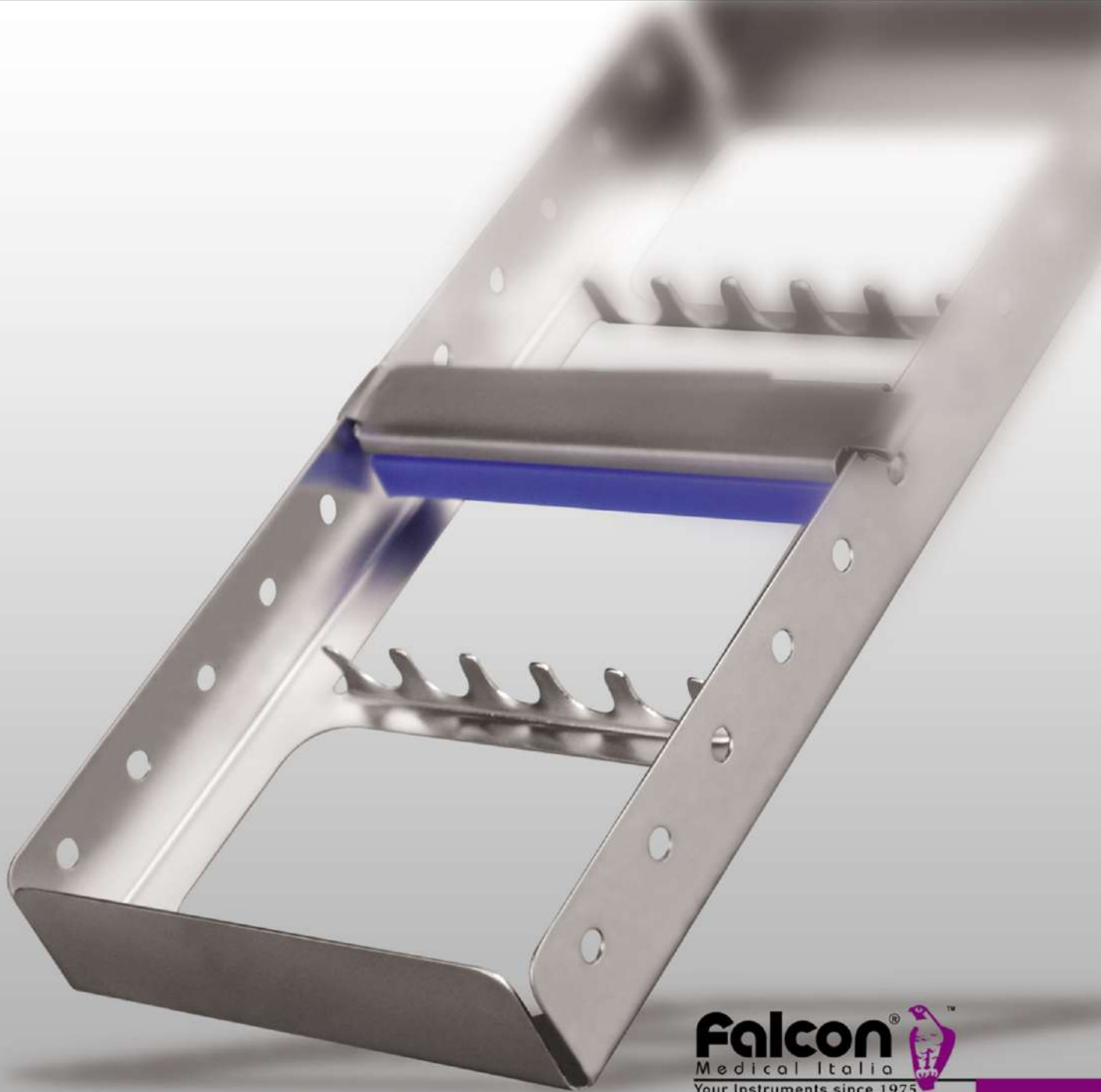

"Cassette trays are the secure and efficient way to organize your hand instruments."
"I Vassoi 'Cassette' consentono una efficiente gestione dei vostri strumenti"



DZ.090.010
Mini
Stainless Steel for 5 instruments
Acciaio inox per 5 strumenti
180 x 85 x 19 mm



DZ.091.010
Midi
Stainless Steel for 10 instruments
Acciaio inox per 10 strumenti
180 x 140 x 25 mm



DZ.095.010
Falcon Mini
Stainless Steel for 7 instruments
Acciaio inox per 7 strumenti
185 x 100 x 15 mm



DZ.100.050
Falcon Mini
Aluminum for 7 instruments
Alluminio per 7 strumenti
185 x 100 x 15 mm

DZ.095.020
Falcon Midi
Stainless Steel for 10 instruments
Acciaio inox per 10 strumenti
185 x 140 x 15 mm

DZ.110.050
Falcon Midi
Aluminum for 10 instruments
Alluminio per 10 strumenti
185 x 140 x 15 mm



Mini

Blue / Blu		DZ.085.010
Green / Verde		DZ.085.013
Red / Rosso		DZ.085.015
Yellow / Giallo		DZ.085.019

Stainless Steel for 5 instruments
Acciaio inox per 5 strumenti
180 x 60 x 22 mm



Midi

	DZ.085.020
	DZ.085.023
	DZ.085.025
	DZ.085.029

Stainless Steel for 10 instruments
Acciaio inox per 10 strumenti
180 x 125 x 22 mm



Maxi

	DZ.085.030
	DZ.085.033
	DZ.085.035
	DZ.085.039

Stainless Steel for 20 instruments
Acciaio inox per 20 strumenti
280 x 180 x 25 mm



Instrument trays aluminum Maxi / Vassoi porta strumenti in alluminio Maxi

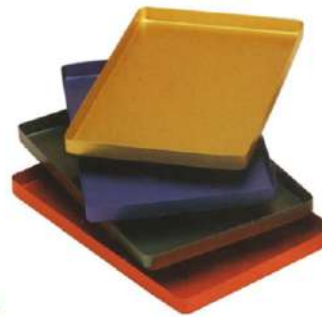

Perforated trays / Vassoio perforato (284 x 183 x 17mm)

Blue / Blu	DZ.400.010
Golden / Oro	DZ.400.020
Green / Verde	DZ.400.030
Red / Rosso	DZ.400.040
Silver / Argento	DZ.400.050

Perforated cover / Coperchio perforato (288 x 187 x 29 mm)

Silver / Argento	DZ.402.010
------------------	------------

Solid trays / Vassoio non perforato (284 x 183 x 17mm)

Blue / Blu	DZ.401.010
Golden / Oro	DZ.401.020
Green / Verde	DZ.401.030
Red / Rosso	DZ.401.040
Silver / Argento	DZ.401.050

Solid cover / Coperchio non perforato (288 x 187 x 29mm)

Silver / Argento	DZ.402.020
------------------	------------

Instrument trays stainless steel Maxi / Vassoi porta strumenti in acciaio inox Maxi



DZ.430.000 Maxi set 1

Solid cover + Perforated tray + Rack for 15 instruments
Coperchio non perforato + Vassoio perforato + Griglia per 15 strumenti
288 x 187 x 40 mm



DZ.431.000 Maxi set 2

Perforated cover + Perforated tray + Rack for 15 instruments
Coperchio perforato + Vassoio perforato + Griglia per 15 strumenti
288 x 187 x 40 mm



DZ.432.000 Maxi set 3

Solid cover + Solid tray + Rack for 15 instruments
Coperchio non perforato + Vassoio non perforato + Griglia per 15 strumenti
288 x 187 x 40 mm



DZ.430.010

Solid cover / Coperchio non perforato
288 x 187 x 29 mm



DZ.430.020

Perforated cover / Coperchio perforato
288 x 187 x 29 mm



DZ.430.040

Solid tray / Vassoio non perforato
284 x 183 x 19 mm



DZ.430.030

Perforated tray / Vassoio perforato
284 x 183 x 19 mm

Aluminum rack Maxi
Rastrelliera in alluminio Maxi



DZ.435.020

for 6 Maxi trays / per 6 vassoi Maxi
295 x 190 x 270mm

Aluminum instrument racks Maxi
Griglia porta strumenti in alluminio Maxi



DZ.430.070

for 15 instruments
per 15 strumenti



DZ.430.071

for 17 instruments
per 17 strumenti

DZ.430.080

for 23 instruments
per 23 strumenti

Instrument trays aluminum Midi / Vassoi porta strumenti in alluminio Midi

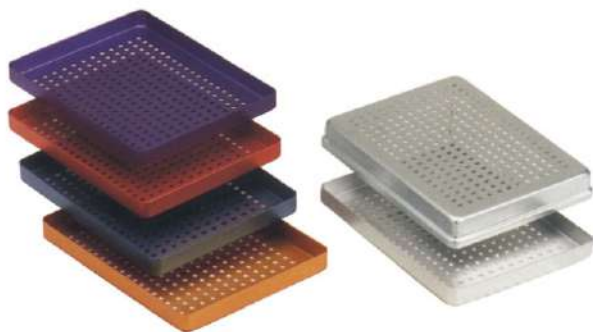

Perforated trays / Vassoio perforato (183 x 140 x 17 mm)

Blue / Blu	DZ.405.010
Golden / Oro	DZ.405.020
Green / Verde	DZ.405.030
Red / Rosso	DZ.405.040
Silver / Argento	DZ.405.050

Perforated cover / Coperchio perforato (187 x 145 x 25mm)

Silver / Argento	DZ.407.010
------------------	------------

Solid trays / Vassoio non perforato (183 x 140 x 17 mm)

Blue / Blu	DZ.406.010
Golden / Oro	DZ.406.020
Green / Verde	DZ.406.030
Red / Rosso	DZ.406.040
Silver / Argento	DZ.406.050

Solid cover / Coperchio non perforato (187 x 145 x 25mm)

Silver / Argento	DZ.407.020
------------------	------------

Instrument trays stainless steel Midi
Vassoi porta strumenti in acciaio inox Midi

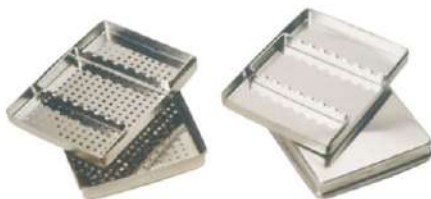

DZ.425.010 Solid cover only / Solo coperchio non perforato
DZ.425.020 Perforated cover only / Solo coperchio perforato
187 x 145 x 25mm

DZ.425.030 Perforated tray only / Solo vassoio perforato
DZ.425.040 Solid tray only / Solo vassoio non perforato
183 x 140 x 17mm

Aluminum instrument racks Midi
Griglie porta strumenti in alluminio Midi



DZ.408.010
for 8 instruments / per 8 strumenti



DZ.408.020
for 4 instruments / per 4 strumenti

Aluminum rack Midi
Rastrelliera in alluminio Midi



DZ.435.010
for 6 Midi trays
per 6 vassoi Midi
150 x 180 x 270mm

Instrument trays aluminum Mini / Vassoi porta strumenti in alluminio Mini

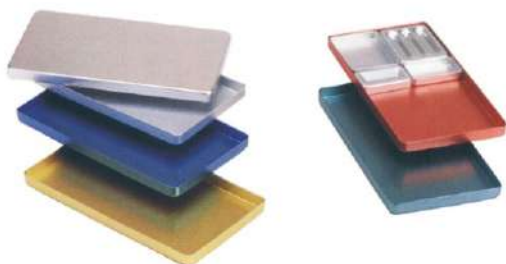

Solid trays / Vassoio non perforato (180 x 100 x 11 mm)

Blue / Blu	DZ.410.010
Golden / Oro	DZ.410.020
Green / Verde	DZ.410.030
Red / Rosso	DZ.410.040
Silver / Argento	DZ.410.050

Solid cover / Coperchio non perforato (182 x 103 x 13 mm)

Silver / Argento	DZ.411.020
------------------	------------

Aluminum inserts / Vaschette in alluminio



Fig. 1
DZ.415.010
49 x 26 x 10mm



Fig. 2
DZ.415.020
49 x 26 x 10mm



Fig. 3
DZ.415.030
59 x 49 x 10mm



Fig. 4
DZ.415.040
59 x 49 x 10mm



Color-Coded System



Cassette trays plastic / 'Cassette' in plastica

Plastic trays and rack
Vassoi in plastica e rastrelliera



Blue / Blu	DZ.084.010
Green / Verde	DZ.084.020
Orange / Arancio	DZ.084.030
Red / Rosso	DZ.084.040
White / Bianco	DZ.084.050
Yellow / Giallo	DZ.084.060

Blue / Blu	DZ.083.010
Green / Verde	DZ.083.020
Orange / Arancio	DZ.083.030
Red / Rosso	DZ.083.040
White / Bianco	DZ.083.050
Yellow / Giallo	DZ.083.060

DZ.390.000
Rack for 6 trays / Rastrelliera per 6 vassoi

Blue / Blu	DZ.390.010
Green / Verde	DZ.390.020
Orange / Arancio	DZ.390.030
Red / Rosso	DZ.390.040
White / Bianco	DZ.390.050
Yellow / Giallo	DZ.390.060

Instrument trays stainless steel / Vassoi porta strumenti in acciaio inox



Fig. 1
DZ.420.010
185 x 80 x 15 mm



Fig. 2
DZ.420.020
190 x 100 x 17 mm



Fig. 3
DZ.420.030
190 x 100 x 25 mm



DZ.420.031
Cover for DZ.420.030
Coperchio per DZ.420.030



Fig. 4
DZ.420.040
190 x 100 x 15 mm



Fig. 5
DZ.420.050
190 x 135 x 15 mm



	A mm	B mm	C mm
DZ.421.010	125	75	25
DZ.421.020	150	120	30
DZ.421.030	200	150	40
JG.500.030	250	200	50
JG.500.050	330	250	50
JG.500.090	450	350	50

Miscellaneous Products Prodotti vari

Instrument boxes stainless steel Contenitori per strumenti in acciaio inox



	A mm	B mm	C mm
DZ.465.000	180	90	30
DZ.470.000	180	100	30
JG.030.100	200	100	50
JG.030.125	200	125	50
JG.035.125	250	125	60
JG.035.150	250	150	60

Instrument box perforated stainless steel Contenitore per strumenti perforato in acciaio inox



DZ.467.000
180 x 90 x 30 mm

Kidney trays stainless steel Vassoi reniformi in acciaio inox



JG.503.150	150 mm
JG.503.180	180 mm
JG.504.200	200 mm
JG.506.250	250 mm

Bowls stainless steel Tazze in acciaio inox



JG.520.090	90 mm
JG.520.100	100 mm
JG.521.125	125 mm
JG.521.150	150 mm
JG.522.200	200 mm

Gallipots stainless steel Tazze in acciaio inox



JG.515.020	50 ml
JG.515.040	100 ml
JG.515.060	150 ml
JG.515.090	225 ml

Forceps jars / Contenitori per pinze

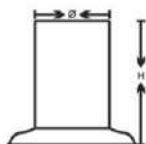

Ø mm	H mm	
50	110	JG.799.110
50	150	JG.799.150

Sterilizing forceps / Pinze per sterilizzazione



JG.820.270
Cheattle
270 mm



JG.830.200 200 mm
JG.830.300 300 mm
Collin

Drinking cup dispensers / Distributori di bicchieri



DZ.201.010



DZ.200.010
Silver / Argento
85 x 85 x 360mm
for 70 cups / per 70 bicchieri



DZ.200.020
White / Bianco
85 x 85 x 360mm
for 70 cups / per 70 bicchieri



Burs disinfecting boxes / Contenitori disinfecta frese

DZ.050.010
Plastic / Plastica
Ø 85 mm x H 70 mm



DZ.051.010
Stainless steel / Acciaio inox
Ø 76 mm x H 35 mm



Mesh burs holder / Contenitore per frese in rete metallica



DZ.052.010
Ø 35mm x L 150 mm

Bur holding tweezers / Pinzetta per trattene le frese



DZ.055.010
165 mm

Magnetic stand for laboratory burs, non-autoclavable
Porta frese magnetico per frese da laboratorio, non autoclavabili



DZ.065.010
Red / Rosso

Transparent burs box / Contenitore trasparente per frese



DZ.058.020

Aluminum burs stands without cover, autoclavable
Porta frese in alluminio senza coperchio, autoclavabile



DZ.062.010
FG for 24 burs / Per 24 frese FG



DZ.063.010
FG for 36 burs / Per 36 frese FG



DZ.062.020
CA/RA for 24 burs / Per 24 frese CA/RA



DZ.063.020
CA/RA for 36 burs / Per 36 frese CA/RA



DZ.062.030
FG & CA/RA for 24 burs / Per 24 frese FG e CA/RA



DZ.063.030
FG & CA/RA for 36 burs / Per 36 frese FG e CA/RA

Transparent covers for bur stands, non-autoclavable
Coperchio trasparente per porta frese, non-autoclavabile



DZ.062.000



DZ.063.000

Brass burs stands, autoclavable / Porta frese in ottone, autoclavabile



DZ.060.010
FG for 12 burs / Per 12 frese FG



DZ.060.020
CA/RA for 12 burs / Per 12 frese CA/RA

Aluminum burs stands, autoclavable / Porta frese in alluminio, autoclavabile



DZ.061.010
FG for 48 burs
Per 48 frese FG

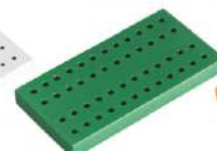

DZ.061.020
CA/RA for 48 burs
Per 48 frese CA/RA



DZ.061.030
FG & CA/RA for 48 burs
Per 48 frese FG e CA/RA

Accessories for Endodontic Instruments Accessori per Strumenti Canalari

Aluminum endodontic instruments cleaner, closed Pulitore per strumenti canalari in alluminio, fondo chiuso



DZ.572.010
Silver / Argento



DZ.572.050
Spare sponges (pack of 50 pieces)
Spugnetta di ricambio (conf. 50 pezzi)
Ø 55 mm x 5 mm



DZ.572.100
Spare sponges (pack of 50 pieces)
Spugnetta di ricambio (conf. 50 pezzi)
Ø 55 mm x 10 mm

Aluminum endodontic tray with cover Vassoio endodontico in alluminio con coperchio



DZ.555.000
257x116x16mm

Stainless steel endodontic/implant tray with cover Vassoio per strumenti canalari e per implantologia in acciaio inox con coperchio



DZ.556.000
205 x 100 x 25 mm

Endometers Misuratori per Strumenti Canalari



DZ.573.000
Endo-Ruler Ultima

Contains:
1 Endo-Ruler (laser etched)
10 Disposable medicament cups
3 Disposable foams

Contiene:
1 righello misuratore (stampato con laser)
10 coppette monouso per medicamento
3 spugnette monouso

Spares / Ricambi
DZ.573.010
Disposable medicament cups (pack of 50)
Coppette monouso per medicamento (Conf. 50 pz.)

DZ.573.020
Disposable foams (pack of 10)
Spugnette monouso (Conf. 10 pz.)



DZ.575.010
Laser etched / Stampato con laser



DZ.574.010



DZ.580.010
100x40x40mm

Transparent plastic stand and boxes for endodontic instruments Porta strumenti canalari e contenitori in plastica trasparente



DZ.564.000



DZ.564.010
Mini



DZ.564.020
Midi



Aluminum Boxes for Endodontic Instruments and Gutta Percha Contenitori per Strumenti Canalari e Guttapercha in Alluminio



Autoclavable
Autoclavabile



Blue / Blu
Red / Rosso
DZ.561.012
DZ.561.015



Blue / Blu
Red / Rosso
DZ.561.022
DZ.561.025



Blue / Blu
Red / Rosso
DZ.561.110
DZ.561.111



Blue / Blu
Red / Rosso
DZ.561.120
DZ.561.121



DZ.560.010
Silver / Argento



Blue / Blu
Red / Rosso
DZ.565.210
DZ.565.211



Blue / Blu
Red / Rosso
DZ.565.220
DZ.565.221



DZ.565.010
Silver / Argento



DZ.565.020
Green / Verde



DZ.565.040
Blue / Blu



DZ.565.030
Golden / Oro



DZ.565.050
Red / Rosso



DZ.565.060
Silver / Argento



DZ.567.010
Midi
125 x 105 x 54mm



DZ.569.010
Maxi
204 x 105 x 54mm



DZ.569.020
Maxi
204 x 105 x 54mm

Sterilization

Cotton rolls dispensers
Distributori rulli salivari



- DZ.525.010 Blue / Blu
- DZ.525.020 Green / Verde
- DZ.525.030 Red / Rosso
- DZ.525.040 White / Bianco
- DZ.525.050 Yellow / Giallo

Cotton rolls holder stainless steel
Porta rulli salivari in acciaio inox

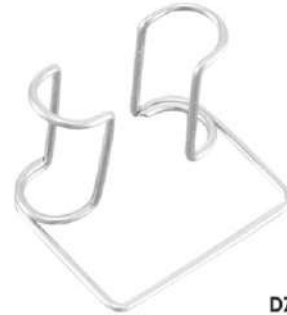

DZ.530.010

Cotton dispensers stainless steel
Distributori di cotone in acciaio inox



DZ.540.010



DZ.540.020

Cotton pellet dispenser stainless steel
Distributore di palline di cotone in acciaio inox



DZ.532.000
40 x 40 x 50 mm

Cotton dispensers aluminum / Distributori di cotone in alluminio



DZ.535.010
Blue / Blu



DZ.535.020
Golden / Oro



DZ.535.030
Green / Verde



DZ.535.040
Red / Rosso



DZ.535.050
Silver / Argento

Cotton waste receiver stainless steel
Raccogliitore per cotone piccolo in acciaio inox



DZ.544.010

Cotton container stainless steel
Contenitore di cotone in acciaio inox



JG.950.100
Ø100 x H 100 mm



Color coding rings / Anelli di Identificazione

Key Features:

- Made of medical grade silicone
- Available in two sizes:
 - Small: inner Ø 4mm
 - Large: inner Ø 6mm



Caratteristiche basilari:

- Prodotti in silicone per uso medicale
- Disponibili in due misure:
 - Piccoli: Ø interno 4mm
 - Grandi: Ø interno 6mm



Small / Piccoli

Color / Colori	Code / Codice	Pack / Conf.
Assorted / Assortiti	DZ.080.001	450 pz.
Assorted / Assortiti	DZ.080.000	50 pz.
Black / Nero	DZ.080.010	50 pz.
Blue Dark / Blu	DZ.080.020	50 pz.
Blue Light / Celeste	DZ.080.030	50 pz.
Brown / Marrone	DZ.080.050	50 pz.
Grey / Grigio	DZ.080.080	50 pz.
Green / Verde	DZ.080.090	50 pz.
Orange / Arancio	DZ.080.110	50 pz.
Pink / Rosa	DZ.080.130	50 pz.
Red / Rosso	DZ.080.150	50 pz.
White / Bianco	DZ.080.170	50 pz.
Yellow / Giallo	DZ.080.180	50 pz.

Large / Grandi

Color / Colori	Code / Codice	Pack / Conf.
Assorted / Assortiti	DZ.081.001	225 pz.
Assorted / Assortiti	DZ.081.000	50 pz.
Black / Nero	DZ.081.010	50 pz.
Blue Dark / Blu	DZ.081.020	50 pz.
Blue Light / Celeste	DZ.081.030	50 pz.
Brown / Marrone	DZ.081.050	50 pz.
Grey / Grigio	DZ.081.080	50 pz.
Green / Verde	DZ.081.090	50 pz.
Orange / Arancio	DZ.081.110	50 pz.
Pink / Rosa	DZ.081.130	50 pz.
Red / Rosso	DZ.081.150	50 pz.
White / Bianco	DZ.081.170	50 pz.
Yellow / Giallo	DZ.081.180	50 pz.

Glass products / Prodotti in vetro

Glass bottles set with stainless steel stand
Set di kappen in vetro con base in acciaio inox



DZ.8510.00

Glass dappen pots / Dappen in vetro



- DZ.8505.01 Blue / Blu
- DZ.8505.02 Clear / Trasparente
- DZ.8505.03 Green / Verde
- DZ.8505.04 Pink / Rosa

Mortar and pestle / Mortaio e Pestello



DZ.9950.00

Protective glasses / Occhiali protettivi



DZ.9000.01
Clear / Trasparenti



DZ.9000.03
Orange / Arancione
Special orange colour filters 98/99% of dangerous blue light frequencies during light curing
Lo speciale colore arancione filtra il 98-99% delle pericolose frequenze di luce blu durante la fotopolimerizzazione



DZ.9000.02
Yellow for vision enhancement
Gialli per esaltare la vista



DZ.9000.04
Black for X-ray protection
Neri protettivi per raggi X

Sterilization

Grinding stones / Pietre per affilare

Round / Rotonda



DZ.9880.03

For currettes, coarse grit, green
Per currettes, grana grossa, verde

Conical / Conica



DZ.9883.01

For elevators and luxators, fine grit, white
Per leve e strumenti di lussazione, grana fine, bianca



Rectangular / Rettangolare



DZ.9885.02

For knives, currettes, scalers etc., medium grit, pink
Per gengivectomia, currettes, levatartaro, ecc., grana media, bianca

Taper round corners / Angoli a smusso arrotondati



DZ.9889.01

For knives, currettes, scalers etc., fine grit, white
Per gengivectomia, currettes, levatartaro, ecc., grana fine, media, bianca

Bibs dispenser / Dispenser per salviette



DZ.2510.00

Handle for acetate sheets / Manico per fogli in acetato

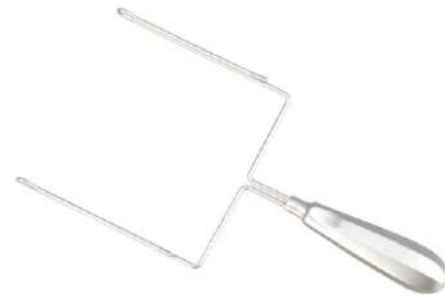

DZ.995.000

X-Ray clip / Pinzetta per radiografie



Fig. 1
DZ.970.010

Bib chains / Catenelle per salviette



DZ.945.020

X-Ray hangers / Appendiradiografie



Fig. 10
DZ.972.100
10 Clips / 10 Pinzette



Fig. 14
DZ.972.140
14 Clips / 14 Pinzette



DZ.945.050

Disposable Products / Prodotti Monouso



Aloecare®

Not Just Another Aloe Vera Glove But : **THE ORIGINAL ALOE VERA GLOVE**
Non Solo Un Altro Guanto Con Aloe Vera: **L'ORIGINALE GUANTO CON ALOE VERA**



BEST SELLER



Protect Your Hands with Aloe Vera Power

Profeggete le Vostre mani con la potenza di Aloe Vera

- *Moisturizing*
- *Continuously conditions skin*
- *Analgesic*
- *Anti-inflammatory*
- *Micro rough surface for better grip*
- *Reinforced wrist band*

- *Idratanti*
- *Costante protezione della pelle*
- *Analgesici*
- *Antinfiammatori*
- *Superficie microruvida per una migliore presa*
- *Bordino rinforzato*

Powder free natural latex gloves
Guanti in lattice naturale privi di polvere

X-Small	GL400AXS	GL400XS
Small	GL400AS	GL400S
Medium	GL400AM	GL400M
Large	GL400AL	GL400L
X-Large	GL400AXL	GL400XL

Box of 100 gloves

10 Boxes of 100 gloves

The Aloe Vera Science Council in the U.S. certify that Aloecare gloves contain a gel of pure Aloe Vera. The presence of this gel (which is activated by the heat of the hands) and the very low protein content (> than 50 micrograms of total water extractable protein) make Aloecare a unique product in protecting and maintaining perfectly moist the skin of the hands.

L' Aloe Vera Science Council negli S. U. certifica che negli Aloecare è presente un gel di pura Aloe Vera. La presenza di detto gel (che si attiva con il calore della mano) ed il basso contenuto proteico (> di 50 microgrammi per grammo di proteina estraibile in veicolo acquoso) fanno di Aloecare un prodotto unico per mantenere la pelle della mani protetta e perfettamente idratata.

Soft flex

The BEST Has Even Got Better!
Il MEGLIO è Stato Superato!



Total Protection Nitrile with Aloe Vera

Protezione totale Nitrile con Aloe Vera

- Hypoallergenic, Latex free nitrile gloves
- Moisturizing
- Continuously conditions skin
- Analgesic
- Anti-inflammatory
- Micro rough surface for better grip
- Reinforced wrist band

- Guanti in Nitrile, ipoallergenici, privi di lattice
- Idratanti
- Costante protezione della pelle
- Analgesici
- Antinfiammatori
- Superficie micro ruvida per una migliore presa
- Bordino rinforzato

Powder free nitrile gloves Guanti in nitrile privi di polvere

X-Small	GL801AXS	GL801XS
Small	GL801AS	GL801S
Medium	GL801AM	GL801M
Large	GL801AL	GL801L

Box of 100 gloves

10 Boxes of 100 gloves



Softflex gloves are made of 100% pure synthetic Nitrile and contain gel of Aloe Vera, these offers all the benefits of Aloecare gloves without any latex allergy concerns.

Softflex gloves offers high level of tactile sensitivity, comfort and puncture resistance. (For safety, these gloves split and tear away when punctured, alerting the wearer of potential for contamination.

The Aloe Vera Science Council in the U.S. certify that Softflex contain a gel of pure Aloe Vera. The presence of this gel (which is activated by the heat of the hands) and non protein product (Nitrile) make Softflex a unique product against the irritation and allergies of the hands often associated with the prolonged use of latex gloves.

I guanti Softflex sono prodotti con 100% puro Nitrile sintetico e contengono un gel di Aloe Vera. Essi offrono i benefici dei guanti Aloecare senza i rischi di allergie derivanti dalle proteine vegetali contenute nel lattice.

I guanti Softflex offrono un elevato livello di sensibilità tattile, confort e resistenza alle forature. (Per sicurezza, ove il guanto subisce una foratura, esso tenderà ad aprirsi totalmente avvertendo quindi l'utente di un potenziale pericolo di contaminazione). L'Aloe Vera Science Council in the U.S. certifica che i guanti Softflex contengono un gel di pura Aloe Vera. La presenza di questo gel (che si attiva con il calore della mano) e l'assenza di proteine vegetali rendono i Softflex un prodotto esclusivo contro l'irritazione e le allergie delle mani associate con l'uso prolungato di guanti in lattice.

Mixing tips 1:1 ratio / Puntali miscelatori rapporto 1:1



For 50 ml round flange dual cartridges
Per cartucce con flangia tonda 50 ml.

For 50 ml/75 ml round flange dual cartridges
Per cartucce con flangia tonda 50/75 ml

For 50 ml rectangular flange dual cartridges
Per cartucce con flangia rettangolare da 50 ml.

Mixing tips fine 1:1 ratio / Puntali miscelatori fini rapporto 1:1



For 50 ml round flange dual cartridges
Per cartucce con flangia tonda 50 ml.

For 25 ml round flange dual cartridges
Per cartucce con flangia tonda 25 ml.



Mixing tips 4:1 ratio / Puntali miscelatori rapporto 4:1



1/1

DR.9811.01
Blue, pack of 50
Blu, conf. di 50

DR.9811.02
Blue, pack of 50
Blu, conf. di 50

DR.9811.03
Blue, pack of 50
Blu, conf. di 50

DR.9811.04
Blue, pack of 50
Blu, conf. di 50

For 25ml round flange dual cartridges
Per cartucce con flangia tonda 25 ml.



1/1

DR.9810.01
Blue, pack of 50
Blu, conf. di 50

DI.1105.10
Yellow, pack of 50
Giallo, conf. di 50

For 50ml round flange dual cartridges
Per cartucce con flangia tonda 50 ml.

Intraoral tips / Terminali intraorali



DI.1100.00
Clear, pack of 50
Trasparente, conf. di 50

DI.1100.01
Clear, pack of 50
Trasparente, conf. di 50

DI.1100.03
Green, pack of 50
Verde, conf. di 50

DI.1100.04
Pink, pack of 50
Rosa, conf. di 50

DI.1100.02
Yellow, pack of 50
Giallo, conf. di 50

DR.9801.00
Clear, pack of 50
Trasparente conf. di 50

Disposable impression syringe / Siringhe monouso per impronta



DI.016.000
Pack of 25 / Conf. di 25

Flowable composite and etching gel tips
Aghi per gel e composito fluido



DR.9980.01
for gel / per gel
Pack of 100 / Conf. di 100



DR.9980.02
for flowable composite / per composito fluido
Pack of 100 / Conf. di 100

Disposable spatulae
Spatoline monouso



DR.997.020
Pack of 200 / Conf. di 200

Disposable micro applicators
for the application of adhesives, liquids and gels

Features:

- Tips bendable to any angle
- Fibres hold material on the surface and allow accurate application and dosage of same
- Total length 100mm with robust handle which may be shortened to 85mm

Microapplicatori monouso
per l'applicazione di adesivi, liquidi o gel

Caratteristiche:

- parte terminale orientabile
- Fibre trattengono il materiale in superficie e consentono applicazione accurata e dosaggio ottimale
- Lunghezza totale di 100mm con manico robusto che consente di ridurre la lunghezza a 85mm



DZ.8619.05
Super Fine
White / Bianco
Pack of 100 / Conf. di 100

DZ.8620.04
Fine
Yellow / Giallo
Pack of 100 / Conf. di 100

DZ.8621.02
Regular
Green / Verde
Pack of 100 / Conf. di 100



Disposable instrument trays maxi
Vassoi monouso in plastica maxi



DZ.455.010
Smooth / Liscio
Pack of 400 / Conf. di 400
284 x 183 x 17 mm

Disposable instrument trays midi
Vassoi monouso in plastica midi



DZ.456.010
Smooth / Liscio
Pack of 400 / Conf. di 400
183 x 140 x 17 mm

Index / Indice

DP.764.200

DD.304.060

DL.1750.00

DE.750.740

DL.655.010

DS.022.010

DA.517.180

DO.555.400

DT.1301.01

DA.517.180

Code Index Indice Per Codice

Code/Codice	Page/Pagina	Code/Codice	Page/Pagina	Code/Codice	Page/Pagina	Code/Codice	Page/Pagina	Code/Codice	Page/Pagina
BA.211.110	105	BC.411.115	109	BD.994.125	111	BM.155.140	115	DA.094.180	56
BA.215.150	105	BC.414.145	109	BD.995.060	32	BM.155.170	115	DA.095.180	60
BA.504.035	105	BC.421.115	109	BF.046.200	112	BM.186.180	115	DA.115.180	57
BA.505.040	105	BC.424.145	109	BF.046.250	112	BM.204.125	116	DA.120.180	59
BA.506.045	105	BC.441.115	109	BF.047.200	112	BM.215.145	116	DA.145.180	60
BA.507.050	105	BC.444.145	109	BF.047.250	112	BM.218.150	116	DA.315.180	57
BB.042.100	9,85	BC.544.145	109	BF.056.200	112	BM.235.140	116	DA.320.180	59
BB.042.130	9,85	BC.554.145	109	BF.056.250	112	BM.235.150	116	DA.517.180	57
BB.044.100	9,85	BC.600.145	109	BF.057.200	112	BM.235.160	116	DA.520.180	60
BB.047.130	9,85	BC.601.145	108	BF.057.250	112	BM.236.180	116	DA.536.180	59
BB.064.050	105	BC.603.145	109	BF.122.250	112	BM.237.200	116	DA.557.180	57
BB.064.051	105	BC.605.145	108	BF.123.250	112	BM.290.140	116	DA.560.180	60
BB.064.057	105	BC.801.090	109	BF.407.090	112	BM.299.160	117	DA.561.180	60
BB.066.054	105	BC.802.130	109	BF.411.090	112	BM.299.161	117	DA.595.180	58
BB.073.030	105	BC.803.140	109	BF.431.090	112	BM.350.120	117	DA.605.180	59
BB.074.030	105	BC.860.090	109	BF.432.110	112	BM.358.140	117	DA.620.180	61
BB.075.030	105	BC.860.110	109	BF.433.130	112	BM.358.170	117	DA.626.180	57
BB.077.070	105	BC.861.140	109	BH.104.100	113	BM.358.200	117	DA.635.180	58
BB.077.077	105	BC.862.180	109	BH.105.100	113	BM.359.140	117	DA.705.180	58
BB.084.040	105	BC.881.180	109	BH.108.125	113	BM.359.170	117	DA.721.180	61
BB.100.150	105	BC.990.115	107	BH.109.125	113	BM.563.010	116	DA.726.180	57
BB.363.630	85	BC.991.115	107	BH.110.125	113	BM.563.140	116	DA.735.180	61
BB.363.632	85	BC.992.115	107	BH.111.125	113	BM.564.010	116	DA.801.180	58
BB.363.638	85	BD.043.100	111	BH.120.125	113	BM.564.140	116	DA.806.180	58
BB.364.640	85	BD.043.115	111	BH.121.125	113	BM.565.010	116	DA.820.180	61
BB.365.650	85	BD.045.130	111	BH.134.140	113	BM.565.140	116	DA.821.180	61
BB.367.675	85	BD.047.145	111	BH.135.140	113	BM.570.130	116	DA.980.000	62
BB.369.690	85	BD.048.150	111	BH.144.140	113	BN.104.145	120	DA.990.000	62
BB.369.695	85	BD.049.160	111	BH.145.140	113	BN.134.145	120	DB.9001.235	142
BB.369.698	85	BD.050.180	111	BH.164.160	113	BT.005.160	118	DB.9116.233	141
BB.510.100	105	BD.051.200	111	BH.165.160	113	BT.008.160	118	DB.9116.235	142
BB.511.110	105	BD.052.250	111	BH.166.160	113	BT.020.120	118	DB.9137.232	142
BB.512.120	105	BD.053.300	111	BH.167.160	113	BT.041.210	118	DB.9137.233	141
BB.513.130	105	BD.151.120	110	BH.200.185	113	BT.111.010	118	DB.9137.235	142
BB.515.150	105	BD.152.120	110	BH.201.185	113	BT.112.020	118	DB.9140.233	141
BB.515.152	105	BD.215.010	110	BH.424.140	113	BT.113.030	118	DB.9187.233	141
BB.520.200	105	BD.215.020	110	BH.425.140	113	BT.114.040	118	DB.9187.235	142
BB.521.210	105	BD.219.120	110	BH.442.160	113	BT.116.010	118	DB.9194.402	142
BB.522.220	105	BD.220.120	110	BH.443.160	113	BT.117.020	118	DB.9194.403	141
BB.523.230	105	BD.222.120	110	BH.614.140	113	BT.118.030	118	DB.9194.405	142
BB.524.240	105	BD.222.150	110	BH.615.140	113	BT.119.040	118	DB.9194.408	142
BB.525.250	105	BD.223.150	110	BH.638.140	113	BT.311.020	119	DB.9194.503	141
BB.542.122	105	BD.228.180	110	BH.639.140	113	BT.312.020	119	DB.9194.505	142
BC.110.115	108	BD.229.180	110	BL.911.650	117	BT.313.020	119	DB.9194.603	141
BC.111.115	108	BD.328.020	111	BL.930.000	117	BT.315.020	119	DB.9194.605	142
BC.116.115	108	BD.328.030	111	BL.941.000	117	BT.316.020	119	DB.9194.608	142
BC.117.115	108	BD.328.040	111	BM.002.010	114	BT.320.020	119	DB.9198.233	141
BC.154.115	108	BD.328.050	111	BM.002.020	114	BT.321.020	119	DB.9199.232	142
BC.155.115	106	BD.328.055	111	BM.002.030	114	BT.323.020	119	DB.9199.235	142
BC.158.160	106	BD.328.070	111	BM.002.040	114	BT.325.020	119	DB.9237.232	142
BC.159.160	106	BD.510.120	110	BM.002.050	114	BT.326.020	119	DB.9237.233	141
BC.160.010	108	BD.511.120	110	BM.002.060	114	BT.359.010	119	DB.9237.603	141
BC.160.011	107	BD.511.150	110	BM.002.070	114	BT.359.020	119	DB.9237.605	142
BC.161.010	108	BD.514.120	110	BM.002.080	114	BT.361.010	119	DB.9255.233	141
BC.161.011	107	BD.520.150	110	BM.002.090	114	BT.361.020	119	DB.9257.233	141
BC.162.010	108	BD.553.115	111	BM.004.010	114	BT.404.215	119	DB.9263.605	142
BC.210.115	106	BD.555.125	111	BM.008.125	115	BT.405.220	119	DB.9274.605	142
BC.211.115	106	BD.557.145	111	BM.012.130	115	BT.406.235	119	DB.9289.233	141
BC.256.115	106	BD.559.160	111	BM.015.145	115	BV.010.070	120	DB.9292.232	142
BC.257.115	106	BD.560.180	111	BM.016.150	115	BV.010.071	120	DB.9292.233	141
BC.260.145	106	BD.561.200	111	BM.030.150	115	BV.071.130	120	DB.9292.235	142
BC.261.145	106	BD.662.180	110	BM.065.160	115	BV.074.130	120	DD.035.000	7
BC.311.115	109	BD.663.180	110	BM.066.180	115	DA.010.180	56	DD.035.010	7
BC.314.145	109	BD.665.010	110	BM.128.140	115	DA.020.180	56	DD.035.020	7
BC.321.115	109	BD.665.020	110	BM.146.140	115	DA.021.180	56	DD.040.000	9
BC.324.145	109	BD.700.120	111	BM.146.170	115	DA.035.000	56	DD.101.020	2
BC.341.115	109	BD.992.140	111	BM.147.140	115	DA.040.180	56	DD.101.030	2
BC.344.145	109	BD.993.135	111	BM.147.170	115	DA.060.180	60	DD.101.050	2

Code Index
Indice Per Codice

Code/Codice	Page/Pagina	Code/Codice	Page/Pagina	Code/Codice	Page/Pagina	Code/Codice	Page/Pagina	Code/Codice	Page/Pagina
DD.1201.00	14	DD.451.233	5	DD.701.128	6	DE.028.010	69	DE.155.047	68
DD.1202.00	14	DD.451.235	5	DD.701.129	6	DE.028.020	69	DE.155.340	68
DD.1203.00	14	DD.451.239	5	DD.701.158	6	DE.028.030	69	DE.155.347	68
DD.1206.00	14	DD.454.239	5	DD.701.159	6	DE.029.010	69	DE.190.050	71
DD.150.160	2	DD.468.010	10	DD.701.180	6	DE.029.020	69	DE.190.057	66
DD.150.170	2	DD.468.020	10	DD.701.263	6	DE.029.030	69	DE.190.070	71
DD.150.171	2	DD.468.030	10	DD.711.073	6	DE.030.010	67	DE.190.077	66
DD.151.623	2	DD.468.040	10	DD.721.131	6	DE.030.020	67	DE.190.080	71
DD.154.170	2	DD.468.050	10	DD.721.132	6	DE.030.030	67	DE.190.087	66
DD.154.171	2	DD.468.060	10	DD.721.133	6	DE.030.040	67	DE.247.010	72
DD.160.170	2	DD.468.070	10	DD.721.134	6	DE.030.050	67	DE.255.060	72
DD.161.050	2	DD.469.010	11	DD.721.232	6	DE.030.060	67	DE.255.070	72
DD.181.023	2	DD.469.020	11	DD.731.234	6	DE.047.200	71	DE.265.320	72
DD.201.060	3	DD.469.030	11	DD.734.230	6	DE.047.210	71	DE.265.321	72
DD.201.061	3	DD.469.040	11	DD.735.230	6	DE.047.220	71	DE.265.322	72
DD.201.080	3	DD.470.010	11	DD.890.010	12	DE.050.011	68	DE.265.323	72
DD.201.081	3	DD.470.020	11	DD.900.150	12	DE.050.017	66	DE.265.350	72
DD.201.090	3	DD.470.030	11	DD.901.150	12	DE.050.021	68	DE.265.351	72
DD.201.170	3	DD.470.031	11	DD.909.050	12	DE.050.027	66	DE.270.015	72
DD.201.230	3	DD.470.040	11	DD.909.055	12	DE.050.031	68	DE.270.017	72
DD.201.320	3	DD.471.010	11	DD.910.050	12	DE.050.037	66	DE.270.115	72
DD.201.650	3	DD.471.020	11	DD.911.050	12	DE.060.307	66	DE.270.117	72
DD.211.060	3	DD.472.000	11	DD.920.010	12	DE.060.317	66	DE.270.125	72
DD.211.061	3	DD.484.025	8	DD.929.050	12	DE.070.250	68	DE.270.127	72
DD.211.090	3	DD.484.040	8	DD.930.050	12	DE.070.260	68	DE.270.135	72
DD.211.230	3	DD.485.030	8	DD.934.010	12	DE.070.310	68	DE.270.137	72
DD.211.320	3	DD.485.050	8	DD.934.015	12	DE.070.320	68	DE.270.145	72
DD.257.010	4	DD.494.000	8	DD.935.010	12	DE.070.440	68	DE.270.147	72
DD.257.020	4	DD.495.000	8	DD.944.010	12	DE.070.450	68	DE.275.145	71
DD.257.030	4	DD.501.040	8	DD.944.015	12	DE.086.010	70	DE.285.067	66
DD.257.040	4	DD.501.050	8	DD.945.010	12	DE.086.011	70	DE.285.077	66
DD.257.050	4	DD.503.040	8	DD.946.010	12	DE.086.020	70	DE.285.117	66
DD.257.060	4	DD.503.050	8	DD.978.130	12	DE.086.021	70	DE.290.010	71
DD.257.070	4	DD.506.020	8	DD.979.130	12	DE.086.027	66	DE.290.011	71
DD.257.080	4	DD.506.030	8	DD.980.130	12	DE.086.030	70	DE.290.017	66
DD.257.090	4	DD.506.040	8	DD.996.061	13	DE.086.031	70	DE.290.020	71
DD.303.020	3	DD.506.050	8	DD.996.090	13	DE.086.037	66	DE.290.021	71
DD.303.030	3	DD.509.020	8	DD.996.230	13	DE.089.010	70	DE.290.027	66
DD.303.031	3	DD.509.030	8	DD.997.060	13	DE.089.020	70	DE.290.030	71
DD.303.050	3	DD.509.040	8	DD.997.090	13	DE.089.030	70	DE.290.031	71
DD.303.060	3	DD.509.050	8	DD.997.230	13	DE.095.017	65	DE.290.037	66
DD.303.080	3	DD.515.040	8	DD.998.230	13	DE.095.027	65	DE.500.001	74
DD.303.090	3	DD.515.050	8	DE.015.301	67	DE.096.017	65	DE.500.137	74
DD.303.100	3	DD.520.010	9	DE.015.302	67	DE.096.037	65	DE.500.227	74
DD.303.110	3	DD.522.010	9	DE.015.303	67	DE.096.047	65	DE.500.307	74
DD.303.120	3	DD.522.015	9	DE.015.304	67	DE.096.067	65	DE.500.337	74
DD.303.160	3	DD.526.000	9	DE.025.010	69	DE.096.077	65	DE.500.370	74
DD.303.170	3	DD.526.010	9	DE.025.011	70	DE.100.010	70	DE.500.380	74
DD.303.171	3	DD.526.020	9	DE.025.017	66	DE.100.020	70	DE.500.390	74
DD.303.230	3	DD.526.030	9	DE.025.020	69	DE.100.030	70	DE.500.395	74
DD.304.020	4	DD.526.040	9	DE.025.030	69	DE.100.040	70	DE.500.397	74
DD.304.060	4	DD.526.050	9	DE.025.040	69	DE.110.010	71	DE.500.517	74
DD.304.080	4	DD.530.010	9	DE.025.050	69	DE.110.020	71	DE.650.000	75
DD.304.090	4	DD.540.010	9	DE.025.060	69	DE.115.010	70	DE.650.030	75
DD.304.100	4	DD.540.015	9	DE.025.061	70	DE.115.020	70	DE.650.050	75
DD.304.110	4	DD.545.010	9	DE.025.067	66	DE.115.030	70	DE.650.060	75
DD.304.120	4	DD.545.015	9	DE.025.070	69	DE.117.010	70	DE.650.070	75
DD.304.160	4	DD.550.032	5	DE.025.071	70	DE.117.020	70	DE.650.517	75
DD.304.170	4	DD.601.141	5	DE.025.077	66	DE.117.030	70	DE.651.370	75
DD.304.230	4	DD.601.142	5	DE.025.080	69	DE.118.021	70	DE.651.390	75
DD.313.060	3	DD.601.233	5	DE.025.090	69	DE.118.022	70	DE.750.000	77
DD.313.090	3	DD.701.020	6	DE.025.100	69	DE.153.040	68	DE.750.010	76
DD.313.110	3	DD.701.080	6	DE.026.010	69	DE.153.050	68	DE.750.020	76
DD.313.160	3	DD.701.110	6	DE.026.020	69	DE.154.010	71	DE.750.040	76
DD.313.230	3	DD.701.111	6	DE.026.030	69	DE.154.020	71	DE.750.070	76
DD.451.113	5	DD.701.115	6	DE.027.010	69	DE.155.015	68	DE.750.080	76
DD.451.123	5	DD.701.120	6	DE.027.020	69	DE.155.017	68	DE.750.130	76
DD.451.230	5	DD.701.127	6	DE.027.030	69	DE.155.045	68	DE.750.170	76

Code Index
Indice Per Codice

Code/Codice	Page/Pagina	Code/Codice	Page/Pagina	Code/Codice	Page/Pagina	Code/Codice	Page/Pagina	Code/Codice	Page/Pagina
DE.750.180	76	DE.803.490	80	DE.997.003	66	DI.040.040	124	DI.520.020	128
DE.750.181	77	DE.803.590	80	DE.997.004	66	DI.040.050	124	DI.520.030	128
DE.750.190	77	DE.825.000	81	DE.997.005	66	DI.1100.00	201	DI.530.010	128
DE.750.210	77	DE.825.010	81	DE.999.001	64	DI.1100.01	201	DI.530.020	128
DE.750.220	77	DE.825.070	81	DE.999.002	64	DI.1100.02	201	DI.530.030	128
DE.750.230	77	DE.825.130	81	DI.001.000	123	DI.1100.03	201	DI.550.000	128
DE.750.240	77	DE.825.170	81	DI.002.000	123	DI.1100.04	201	DI.560.000	128
DE.750.290	77	DE.825.180	81	DI.005.010	123	DI.1105.00	200	DI.600.000	127
DE.750.295	77	DE.825.220	81	DI.005.014	123	DI.1105.01	200	DI.600.010	127
DE.750.330	78	DE.825.331	81	DI.005.020	123	DI.1105.02	200	DI.600.020	127
DE.750.331	78	DE.825.511	81	DI.005.024	123	DI.1105.03	200	DI.600.030	127
DE.750.335	78	DE.825.671	81	DI.006.020	123	DI.1105.05	200	DI.600.040	127
DE.750.450	78	DE.825.790	81	DI.009.010	123	DI.1105.06	200	DI.610.000	127
DE.750.463	78	DE.875.010	82	DI.010.014	123	DI.1105.10	201	DI.610.010	127
DE.750.510	78	DE.875.020	82	DI.010.017	123	DI.1150.00	122	DI.610.020	127
DE.750.511	78	DE.875.030	82	DI.016.000	201	DI.151.030	173	DI.610.030	127
DE.750.515	78	DE.881.225	82	DI.020.010	124	DI.151.040	173	DI.610.040	127
DE.750.670	79	DE.881.227	82	DI.025.000	124	DI.151.050	173	DI.640.000	127
DE.750.671	79	DE.898.010	82	DI.025.030	124	DI.156.006	173	DI.700.010	126
DE.750.730	79	DE.898.020	82	DI.025.040	124	DI.156.030	173	DI.700.020	126
DE.750.740	79	DE.900.010	82	DI.025.050	124	DI.156.040	173	DI.700.030	126
DE.750.743	79	DE.900.020	82	DI.025.060	124	DI.156.050	173	DI.700.040	126
DE.750.750	79	DE.920.000	67	DI.025.110	124	DI.200.010	127	DI.700.050	126
DE.750.790	79	DE.920.010	67	DI.025.120	124	DI.200.020	127	DI.700.060	126
DE.750.861	79	DE.920.017	65	DI.025.130	124	DI.200.030	127	DI.705.010	126
DE.750.863	80	DE.920.020	67	DI.025.140	124	DI.210.010	127	DI.705.020	126
DE.750.870	80	DE.920.027	65	DI.025.150	124	DI.210.020	127	DI.705.030	126
DE.751.450	80	DE.920.030	67	DI.025.160	124	DI.210.030	127	DI.705.040	126
DE.751.510	80	DE.920.037	65	DI.025.170	124	DI.220.010	127	DI.705.050	126
DE.753.490	80	DE.920.040	67	DI.025.180	124	DI.220.020	127	DI.705.060	126
DE.753.590	80	DE.920.047	65	DI.025.200	124	DI.220.030	127	DI.710.010	126
DE.800.000	79	DE.920.050	67	DI.025.210	124	DI.230.010	127	DI.710.020	126
DE.800.010	76	DE.920.057	65	DI.025.220	124	DI.230.020	127	DI.710.030	126
DE.800.020	76	DE.920.060	67	DI.026.000	124	DI.230.030	127	DI.710.040	126
DE.800.040	76	DE.920.067	65	DI.026.030	124	DI.250.000	127	DI.710.050	126
DE.800.070	76	DE.920.070	67	DI.026.040	124	DI.260.000	127	DI.710.060	126
DE.800.080	76	DE.920.077	65	DI.026.050	124	DI.300.010	128	DI.715.010	126
DE.800.130	76	DE.925.010	73	DI.026.060	124	DI.300.020	128	DI.715.020	126
DE.800.170	76	DE.925.020	73	DI.026.110	124	DI.300.030	128	DI.715.030	126
DE.800.180	76	DE.925.030	73	DI.026.120	124	DI.300.040	128	DI.715.040	126
DE.800.181	77	DE.925.040	73	DI.026.130	124	DI.310.010	128	DI.715.050	126
DE.800.190	77	DE.929.010	73	DI.026.140	124	DI.310.020	128	DI.715.060	126
DE.800.210	77	DE.930.000	73	DI.026.150	124	DI.310.030	128	DI.720.000	126
DE.800.220	77	DE.930.010	73	DI.026.160	124	DI.310.040	128	DI.720.060	126
DE.800.230	77	DE.930.020	73	DI.026.170	124	DI.320.010	128	DI.720.080	126
DE.800.240	77	DE.930.030	73	DI.026.180	124	DI.320.020	128	DI.725.000	126
DE.800.290	77	DE.930.040	73	DI.026.200	124	DI.320.030	128	DI.725.060	126
DE.800.295	77	DE.930.050	73	DI.026.210	124	DI.320.040	128	DI.725.080	126
DE.800.330	78	DE.930.060	73	DI.026.220	124	DI.330.010	128	DI.750.010	126
DE.800.331	78	DE.930.070	73	DI.029.000	124	DI.330.020	128	DI.750.020	126
DE.800.335	78	DE.930.080	73	DI.029.010	124	DI.330.030	128	DI.750.030	126
DE.800.450	78	DE.930.090	73	DI.029.020	124	DI.330.040	128	DI.750.040	126
DE.800.463	78	DE.930.110	73	DI.029.030	124	DI.350.000	128	DI.750.050	126
DE.800.510	78	DE.930.210	73	DI.029.040	124	DI.360.000	128	DI.750.060	126
DE.800.511	78	DE.930.220	73	DI.029.050	124	DI.400.010	128	DI.755.010	126
DE.800.515	78	DE.930.230	73	DI.029.060	124	DI.400.020	128	DI.755.020	126
DE.800.670	79	DE.930.240	73	DI.029.070	124	DI.400.030	128	DI.755.030	126
DE.800.671	79	DE.930.250	73	DI.029.080	124	DI.410.010	128	DI.755.040	126
DE.800.730	79	DE.930.260	73	DI.029.090	124	DI.410.020	128	DI.755.050	126
DE.800.740	79	DE.930.270	73	DI.039.000	124	DI.410.030	128	DI.755.060	126
DE.800.743	79	DE.930.280	73	DI.039.010	124	DI.450.000	128	DI.760.010	126
DE.800.750	79	DE.930.290	73	DI.039.020	124	DI.500.010	128	DI.760.020	126
DE.800.790	79	DE.931.010	73	DI.039.030	124	DI.500.020	128	DI.760.030	126
DE.800.861	79	DE.931.020	73	DI.039.040	124	DI.500.030	128	DI.760.040	126
DE.800.863	80	DE.975.010	82	DI.039.050	124	DI.510.010	128	DI.760.050	126
DE.800.870	80	DE.975.020	82	DI.040.010	124	DI.510.020	128	DI.760.060	126
DE.801.450	80	DE.997.001	65	DI.040.020	124	DI.510.030	128	DI.765.010	126
DE.801.510	80	DE.997.002	65	DI.040.030	124	DI.520.010	128	DI.765.020	126

Code Index Indice Per Codice

Code/Codice	Page/Pagina	Code/Codice	Page/Pagina	Code/Codice	Page/Pagina	Code/Codice	Page/Pagina	Code/Codice	Page/Pagina
DI.765.030	126	DI.900.990	129	DL.050.000	133	DL.500.031	135	DL.864.070	140
DI.765.040	126	DI.901.010	129	DL.050.001	133	DL.500.041	135	DL.864.120	139
DI.765.050	126	DI.901.020	129	DL.050.002	133	DL.501.017	135	DL.864.130	139
DI.765.060	126	DI.901.030	129	DL.050.003	133	DL.501.027	135	DL.870.310	139
DI.770.000	126	DI.901.040	129	DL.050.004	133	DL.501.037	135	DL.870.314	139
DI.770.060	126	DI.901.050	129	DL.060.000	133	DL.650.000	135	DL.875.010	140
DI.770.080	126	DI.901.060	129	DL.090.010	130	DL.650.010	135	DL.875.030	140
DI.780.000	126	DI.905.300	129	DL.090.020	130	DL.650.020	135	DL.875.050	140
DI.780.060	126	DI.905.310	129	DL.091.010	130	DL.655.000	135	DL.875.060	140
DI.780.080	126	DI.905.320	129	DL.092.010	130	DL.655.010	135	DL.875.100	139
DI.800.010	127	DI.905.330	129	DL.092.020	130	DL.655.020	135	DL.880.010	140
DI.800.020	127	DI.905.990	129	DL.092.030	130	DL.655.030	135	DL.880.020	140
DI.800.030	127	DI.950.010	130	DL.093.010	130	DL.700.310	135	DL.880.030	140
DI.800.040	127	DI.950.020	130	DL.093.020	130	DL.705.400	135	DL.880.040	140
DI.800.050	127	DI.950.030	130	DL.100.010	134	DL.715.560	135	DL.880.070	140
DI.801.010	125	DI.950.040	130	DL.100.020	134	DL.780.010	135	DL.880.080	140
DI.801.020	125	DI.950.050	130	DL.1000.00	132	DL.780.020	135	DL.880.100	139
DI.801.030	125	DI.950.060	130	DL.101.030	134	DL.790.200	135	DL.882.010	140
DI.801.040	125	DI.960.010	130	DL.101.040	134	DL.790.300	135	DL.882.020	140
DI.801.050	125	DI.960.020	130	DL.1010.00	132	DL.805.010	137	DL.882.030	140
DI.810.010	127	DI.960.030	130	DL.150.010	134	DL.805.020	137	DL.900.000	139
DI.810.020	127	DI.960.040	130	DL.150.020	134	DL.810.010	137	DL.900.010	139
DI.810.030	127	DI.960.050	130	DL.160.120	134	DL.810.020	137	DL.900.020	139
DI.810.040	127	DI.960.060	130	DL.161.120	134	DL.810.030	137	DL.900.030	139
DI.810.050	127	DI.970.000	130	DL.255.010	134	DL.815.010	137	DL.900.040	139
DI.811.010	125	DI.980.010	130	DL.255.020	134	DL.815.020	137	DL.900.050	139
DI.811.020	125	DI.980.020	130	DL.325.200	135	DL.815.030	137	DL.904.000	139
DI.811.030	125	DI.980.030	130	DL.326.200	135	DL.815.040	137	DL.904.010	139
DI.811.040	125	DI.985.010	130	DL.330.010	136	DL.815.050	137	DL.904.020	139
DI.811.050	125	DI.985.020	130	DL.331.010	136	DL.815.051	137	DL.904.030	139
DI.820.010	127	DI.985.030	130	DL.332.010	136	DL.815.052	137	DL.904.040	139
DI.820.020	127	DI.999.000	130	DL.335.160	136	DL.815.053	137	DL.904.050	139
DI.820.030	127	DL.009.000	132	DL.335.170	136	DL.815.054	137	DL.905.000	138
DI.820.040	127	DL.010.000	132	DL.336.160	136	DL.815.055	137	DL.905.010	138
DI.820.050	127	DL.015.010	132	DL.336.170	136	DL.815.060	137	DL.905.020	138
DI.821.010	125	DL.015.020	132	DL.337.160	136	DL.815.061	137	DL.905.030	138
DI.821.020	125	DL.019.010	132	DL.337.170	136	DL.815.062	137	DL.905.040	138
DI.821.030	125	DL.019.020	132	DL.340.180	136	DL.815.063	137	DL.905.050	138
DI.821.040	125	DL.020.010	134	DL.350.010	136	DL.815.064	137	DL.918.010	139
DI.821.050	125	DL.024.050	132	DL.350.011	136	DL.815.065	137	DL.932.010	139
DI.830.010	127	DL.024.051	132	DL.350.021	136	DL.815.070	137	DL.945.010	140
DI.830.020	127	DL.024.057	132	DL.350.030	136	DL.815.080	137	DL.945.020	140
DI.830.030	127	DL.025.050	132	DL.350.040	136	DL.825.010	137	DL.945.030	140
DI.830.040	127	DL.025.051	132	DL.350.050	136	DL.825.020	137	DL.945.040	140
DI.830.050	127	DL.025.057	132	DL.350.060	136	DL.825.030	137	DL.945.050	140
DI.831.010	125	DL.026.857	132	DL.351.050	136	DL.825.040	137	DL.945.060	140
DI.831.020	125	DL.026.150	132	DL.351.060	136	DL.825.050	137	DL.945.100	139
DI.831.030	125	DL.026.151	132	DL.400.010	136	DL.825.051	137	DL.949.010	138
DI.831.040	125	DL.026.157	132	DL.400.020	136	DL.825.052	137	DL.949.011	138
DI.831.050	125	DL.026.250	132	DL.410.170	136	DL.825.053	137	DL.949.020	138
DI.850.000	127	DL.026.251	132	DL.415.200	136	DL.825.054	137	DL.949.021	138
DI.850.060	127	DL.026.257	132	DL.450.030	136	DL.825.055	137	DL.949.030	138
DI.851.000	125	DL.026.550	132	DL.450.040	136	DL.825.060	137	DL.949.031	138
DI.851.060	125	DL.026.551	132	DL.450.050	136	DL.825.061	137	DL.950.000	138
DI.860.000	127	DL.026.557	132	DL.450.060	136	DL.825.062	137	DL.950.010	138
DI.860.060	127	DL.026.850	132	DL.450.070	136	DL.825.063	137	DL.950.020	138
DI.861.000	125	DL.026.851	132	DL.450.080	136	DL.825.064	137	DL.950.030	138
DI.861.060	125	DL.027.000	132	DL.450.090	136	DL.825.065	137	DL.955.000	138
DI.899.010	129	DL.038.000	133	DL.460.010	137	DL.825.070	137	DL.955.010	138
DI.899.020	129	DL.038.002	133	DL.461.010	137	DL.825.080	137	DL.955.020	138
DI.899.030	129	DL.038.003	133	DL.461.020	137	DL.855.010	139	DL.955.030	138
DI.899.040	129	DL.038.004	133	DL.461.030	137	DL.856.070	139	DO.120.010	145
DI.899.050	129	DL.039.000	133	DL.461.040	137	DL.864.010	140	DO.125.010	145
DI.899.060	129	DL.039.001	133	DL.461.050	137	DL.864.020	140	DO.130.010	145
DI.900.300	129	DL.040.000	133	DL.461.060	137	DL.864.030	140	DO.130.014	145
DI.900.310	129	DL.045.000	133	DL.461.070	137	DL.864.040	140	DO.145.010	145
DI.900.320	129	DL.045.001	133	DL.500.011	135	DL.864.050	140	DO.151.000	144
DI.900.330	129	DL.045.002	133	DL.500.021	135	DL.864.060	140	DO.155.010	144

Code Index Indice Per Codice

Code/Codice	Page/Pagina	Code/Codice	Page/Pagina	Code/Codice	Page/Pagina	Code/Codice	Page/Pagina	Code/Codice	Page/Pagina
DO.155.020	144	DO.492.700	162	DO.620.700	165	DO.786.400	166	DP.006.010	16
DO.155.030	144	DO.492.750	160	DO.621.300	156	DO.787.300	166	DP.006.020	16
DO.155.040	144	DO.495.010	151	DO.621.700	165	DO.795.300	167	DP.006.030	16
DO.160.000	144	DO.495.020	151	DO.6220.00	176	DO.796.100	167	DP.006.040	16
DO.165.150	144	DO.497.300	151	DO.623.300	156	DO.796.300	167	DP.006.050	16
DO.165.300	144	DO.498.300	151	DO.623.700	164	DO.798.300	167	DP.006.060	16
DO.170.000	144	DO.502.300	151	DO.624.700	164	DO.799.100	167	DP.007.010	16
DO.172.000	144	DO.505.010	152	DO.630.700	165	DO.799.300	167	DP.007.030	16
DO.175.000	144	DO.505.300	152	DO.6320.00	174	DO.806.300	169	DP.007.040	16
DO.180.000	144	DO.510.300	152	DO.6320.01	174	DO.807.300	169	DP.008.010	16
DO.1990.00	176	DO.510.700	162	DO.6320.02	174	DO.808.300	169	DP.008.030	16
DO.200.010	146	DO.511.300	152	DO.6320.03	174	DO.810.300	172	DP.008.040	16
DO.205.018	146	DO.511.700	162	DO.6320.04	174	DO.812.300	168	DP.009.030	16
DO.205.022	146	DO.520.300	152	DO.6320.05	174	DO.813.300	168	DP.009.040	16
DO.209.010	146	DO.520.700	162	DO.6320.06	174	DO.830.300	168	DP.010.030	16
DO.210.135	146	DO.520.750	160	DO.6320.07	174	DO.835.300	168	DP.010.040	16
DO.213.135	146	DO.525.010	162	DO.6320.08	174	DO.845.100	170	DP.078.010	101
DO.214.135	146	DO.525.700	162	DO.6320.10	174	DO.850.300	170	DP.078.020	101
DO.215.135	146	DO.535.700	161	DO.6320.11	174	DO.860.300	168	DP.085.013	20
DO.217.135	146	DO.536.200	153	DO.6350.00	174	DO.861.300	168	DP.085.023	20
DO.220.110	146	DO.536.700	161	DO.6350.01	174	DO.870.300	169	DP.125.140	20
DO.227.120	145	DO.537.200	153	DO.6350.02	174	DO.871.300	169	DP.125.145	20
DO.227.135	145	DO.538.200	153	DO.6350.03	174	DO.872.300	169	DP.128.020	20
DO.228.125	145	DO.5390.00	176	DO.6350.04	174	DO.874.300	170	DP.128.025	20
DO.228.135	145	DO.5390.01	176	DO.6350.05	174	DO.876.300	170	DP.128.040	20
DO.235.010	146	DO.542.200	153	DO.6350.06	174	DO.877.300	170	DP.128.045	20
DO.235.014	146	DO.542.700	161	DO.6350.07	174	DO.884.300	171	DP.156.000	17
DO.240.010	148	DO.542.750	160	DO.6350.08	174	DO.885.300	171	DP.156.021	17
DO.240.020	148	DO.544.200	153	DO.6350.10	174	DO.886.300	171	DP.156.041	17
DO.241.010	148	DO.545.700	161	DO.6350.11	174	DO.888.300	172	DP.156.061	17
DO.241.020	148	DO.550.100	154	DO.641.700	165	DO.892.300	172	DP.156.081	17
DO.245.010	148	DO.550.700	162	DO.655.700	165	DO.895.300	171	DP.156.101	17
DO.250.010	147	DO.555.100	154	DO.661.100	157	DO.896.300	170	DP.156.111	17
DO.250.014	147	DO.555.400	162	DO.661.300	157	DO.910.010	148	DP.156.141	17
DO.255.010	147	DO.555.700	162	DO.662.100	157	DO.911.010	148	DP.160.020	19
DO.258.014	147	DO.555.750	160	DO.662.300	157	DO.950.010	175	DP.160.021	17
DO.270.155	149	DO.565.200	154	DO.664.300	157	DO.952.010	175	DP.160.024	18
DO.270.160	149	DO.565.300	154	DO.664.700	163	DO.952.020	175	DP.160.025	19
DO.271.165	149	DO.571.200	154	DO.665.300	157	DO.952.030	175	DP.160.040	19
DO.272.165	149	DO.571.300	154	DO.665.700	163	DO.952.040	175	DP.160.041	17
DO.285.010	149	DO.572.700	161	DO.675.300	157	DO.952.050	175	DP.160.044	18
DO.290.120	149	DO.572.750	160	DO.675.700	164	DO.952.060	175	DP.160.045	19
DO.291.120	149	DO.574.100	154	DO.688.300	157	DO.952.070	175	DP.160.060	19
DO.292.120	149	DO.574.700	161	DO.688.700	165	DO.952.080	175	DP.160.061	17
DO.294.140	149	DO.575.700	161	DO.700.010	158	DO.952.090	175	DP.160.064	18
DO.295.140	149	DO.578.100	154	DO.700.200	158	DO.952.100	175	DP.160.065	19
DO.298.000	145	DO.578.700	161	DO.705.300	157	DO.963.010	175	DP.160.080	19
DO.299.041	145	DO.580.700	164	DO.705.700	163	DO.963.020	175	DP.160.081	17
DO.300.000	145	DO.585.300	155	DO.710.200	158	DO.963.030	175	DP.160.084	18
DO.365.014	147	DO.585.700	164	DO.711.700	164	DO.963.040	175	DP.160.085	19
DO.375.010	147	DO.590.300	155	DO.712.300	158	DO.964.010	175	DP.160.100	19
DO.375.014	147	DO.592.300	155	DO.713.300	156	DO.965.010	175	DP.160.101	17
DO.376.010	147	DO.592.700	163	DO.713.700	165	DO.965.020	175	DP.160.104	18
DO.376.014	147	DO.598.700	164	DO.735.100	158	DO.965.040	175	DP.160.105	19
DO.377.010	147	DO.5980.01	176	DO.735.300	158	DO.965.080	175	DP.160.110	19
DO.377.014	147	DO.5981.02	176	DO.735.700	163	DO.966.000	176	DP.160.111	17
DO.385.160	150	DO.5982.01	176	DO.736.300	158	DO.966.020	176	DP.160.114	18
DO.388.160	150	DO.602.300	155	DO.738.100	158	DO.966.030	176	DP.160.115	19
DO.392.010	150	DO.608.700	163	DO.738.300	158	DP.004.010	16,84	DP.160.124	18
DO.392.020	150	DO.609.700	163	DO.738.500	158	DP.004.020	16,84	DP.160.134	18
DO.392.030	150	DO.610.300	155	DO.738.700	163	DP.004.030	16	DP.160.140	19
DO.393.030	150	DO.610.700	163	DO.738.750	160	DP.005.000	16	DP.160.141	17
DO.395.140	150	DO.613.700	164	DO.777.100	166	DP.005.010	16	DP.160.144	18
DO.396.140	150	DO.615.300	156	DO.777.300	166	DP.005.020	16	DP.160.145	19
DO.400.014	148	DO.616.300	156	DO.779.100	166	DP.005.030	16	DP.160.164	18
DO.465.300	151	DO.618.300	155	DO.779.300	166	DP.005.040	16	DP.160.184	18
DO.475.300	151	DO.618.700	165	DO.785.300	166	DP.005.050	16	DP.365.050	20
DO.492.300	151	DO.620.300	156	DO.786.300	166	DP.005.060	16	DP.365.055	20

Code Index
Indice Per Codice

Code/Codice	Page/Pagina	Code/Codice	Page/Pagina	Code/Codice	Page/Pagina	Code/Codice	Page/Pagina	Code/Codice	Page/Pagina
DP.365.060	20	DP.895.047	24	DR.041.004	30	DR.095.010	37	DR.279.020	48
DP.365.065	20	DP.895.055	24	DR.041.014	30	DR.095.020	37	DR.279.030	48
DP.375.075	20	DP.895.057	24	DR.045.004	30	DR.098.010	36	DR.279.040	48
DP.375.095	20	DP.895.065	24	DR.046.004	30	DR.100.011	34	DR.280.054	48
DP.469.160	97	DP.895.067	24	DR.047.004	30	DR.100.017	40	DR.280.064	48
DP.469.165	97	DP.895.075	24	DR.050.010	37	DR.101.011	34	DR.280.924	48
DP.480.020	97	DP.895.077	24	DR.050.014	38	DR.101.017	40	DR.282.904	48
DP.480.025	97	DP.900.015	24	DR.050.017	40	DR.110.210	39	DR.296.065	48
DP.500.013	97	DP.900.017	24	DR.050.020	37	DR.110.214	40	DR.297.024	47
DP.500.023	97	DP.900.025	24	DR.050.024	38	DR.110.215	39	DR.297.025	48
DP.635.155	96	DP.900.027	24	DR.050.027	40	DR.111.210	39	DR.298.024	47
DP.635.165	96	DP.900.035	24	DR.050.030	37	DR.111.211	34	DR.298.025	48
DP.637.145	96	DP.900.037	24	DR.050.034	38	DR.111.214	40	DR.2990.00	27
DP.640.205	96	DP.930.015	24	DR.050.037	40	DR.111.215	39	DR.2990.01	27
DP.643.015	96	DP.930.017	24	DR.051.051	34	DR.118.017	40	DR.2990.02	27
DP.643.025	96	DP.930.025	24	DR.063.011	34	DR.118.027	40	DR.2990.03	27
DP.658.035	96	DP.930.027	24	DR.063.017	38	DR.118.037	40	DR.2991.01	27
DP.660.090	96	DP.930.035	24	DR.063.021	34	DR.118.047	40	DR.2991.02	27
DP.660.095	96	DP.930.037	24	DR.063.027	38	DR.119.017	40	DR.2991.03	27
DP.663.100	97	DP.930.045	24	DR.068.010	37	DR.119.027	40	DR.300.010	36
DP.665.034	96	DP.930.047	24	DR.068.020	37	DR.119.037	40	DR.300.030	36
DP.665.035	96	DP.930.067	24	DR.068.030	37	DR.119.047	40	DR.300.284	47
DP.666.094	96	DP.930.075	24	DR.069.010	37	DR.120.180	39	DR.300.294	47
DP.667.210	97	DP.930.077	24	DR.069.020	37	DR.120.187	40	DR.3001.00	26
DP.667.230	97	DP.930.097	24	DR.069.030	37	DR.121.011	34	DR.3001.01	26
DP.705.150	97	DP.930.127	24	DR.073.031	34	DR.121.021	34	DR.3001.08	26
DP.706.150	97	DP.930.327	24	DR.077.010	37	DR.126.290	39	DR.3001.10	26
DP.763.010	22	DP.930.335	24	DR.077.020	37	DR.126.310	39	DR.3001.15	26
DP.763.014	21	DP.930.337	24	DR.077.030	37	DR.126.340	39	DR.3001.20	26
DP.763.015	23	DP.930.345	24	DR.077.040	37	DR.130.004	40	DR.3001.25	26
DP.763.020	22	DP.930.347	24	DR.077.050	37	DR.130.010	39	DR.3001.30	26
DP.763.021	21	DP.931.335	24	DR.078.030	37	DR.130.014	40	DR.3001.35	26
DP.763.024	21	DP.931.337	24	DR.078.050	37	DR.130.015	39	DR.3001.40	26
DP.763.025	23	DP.931.345	24	DR.079.017	38	DR.130.020	39	DR.3001.45	26
DP.764.020	22	DP.931.347	24	DR.079.027	38	DR.130.024	40	DR.3001.50	26
DP.764.024	21	DP.940.155	24	DR.079.037	38	DR.130.025	39	DR.3001.55	26
DP.764.025	23	DP.940.157	24	DR.079.047	38	DR.130.030	39	DR.3001.60	26
DP.772.030	22	DP.960.017	24	DR.080.017	38	DR.130.034	40	DR.3001.70	26
DP.772.034	21	DP.960.027	24	DR.080.027	38	DR.130.035	39	DR.3001.80	26
DP.772.035	23	DP.960.047	24	DR.080.037	38	DR.130.040	39	DR.3002.00	26
DP.773.060	22	DP.960.057	24	DR.080.047	38	DR.130.044	40	DR.3002.01	26
DP.773.064	21	DP.960.067	24	DR.081.010	37	DR.130.045	39	DR.3002.08	26
DP.773.065	23	DP.999.011	17	DR.081.014	38	DR.130.050	39	DR.3002.10	26
DP.786.070	22	DP.999.014	18	DR.081.020	37	DR.130.054	40	DR.3002.15	26
DP.786.071	21	DP.999.015	19	DR.081.024	38	DR.130.055	39	DR.3002.20	26
DP.786.074	21	DP.999.020	19	DR.081.030	37	DR.132.034	40	DR.3002.25	26
DP.786.075	23	DQ.8000.01	14	DR.081.034	38	DR.135.551	34	DR.3002.30	26
DP.790.034	21	DQ.8005.01	14	DR.081.040	37	DR.139.020	39	DR.3002.35	26
DP.791.034	21	DQ.8010.01	14	DR.081.044	38	DR.139.021	34	DR.3002.40	26
DP.792.320	22	DQ.8015.01	14	DR.081.050	37	DR.139.030	39	DR.3002.45	26
DP.792.325	23	DR.001.010	36	DR.081.054	38	DR.139.031	34	DR.3002.50	26
DP.792.330	22	DR.001.020	36	DR.081.060	37	DR.148.020	39	DR.3002.55	26
DP.792.335	23	DR.001.030	36	DR.081.064	38	DR.148.040	39	DR.3002.60	26
DP.793.020	22	DR.001.040	36	DR.089.010	37	DR.148.041	34	DR.3002.70	26
DP.793.025	23	DR.006.010	36	DR.089.014	38	DR.148.044	40	DR.3002.80	26
DP.793.040	22	DR.006.020	36	DR.089.020	37	DR.148.045	39	DR.3003.00	26
DP.793.045	23	DR.006.030	36	DR.089.024	38	DR.148.060	39	DR.3003.01	26
DP.793.050	22	DR.006.040	36	DR.089.030	37	DR.225.030	47	DR.3003.08	26
DP.793.055	23	DR.022.101	36	DR.089.034	38	DR.230.030	47	DR.3003.10	26
DP.803.031	21	DR.023.010	36	DR.089.040	37	DR.230.034	47	DR.3003.15	26
DP.803.051	21	DR.024.020	36	DR.089.044	38	DR.231.020	47	DR.3003.20	26
DP.827.030	22	DR.024.030	36	DR.090.010	37	DR.231.024	47	DR.3003.25	26
DP.827.034	21	DR.026.010	36	DR.090.020	37	DR.235.010	47	DR.3003.30	26
DP.827.035	23	DR.026.020	36	DR.090.030	37	DR.235.020	47	DR.3003.35	26
DP.835.080	22	DR.026.030	36	DR.090.040	37	DR.270.010	47	DR.3003.40	26
DP.835.085	23	DR.028.010	36	DR.091.011	34	DR.270.020	47	DR.3003.45	26
DP.877.117	24	DR.040.014	30	DR.091.014	38	DR.274.080	47	DR.3003.50	26
DP.895.045	24	DR.040.024	30	DR.092.001	34	DR.279.010	48	DR.3003.55	26

Code Index Indice Per Codice

Code/Codice	Page/Pagina	Code/Codice	Page/Pagina	Code/Codice	Page/Pagina	Code/Codice	Page/Pagina	Code/Codice	Page/Pagina
DR.3003.60	26	DR.3022.35	27	DR.3051.40	26	DR.3063.01	26	DR.425.060	41
DR.3003.70	26	DR.3022.40	27	DR.3051.45	26	DR.3063.10	26	DR.425.061	35
DR.3003.80	26	DR.3022.45	27	DR.3051.50	26	DR.3063.15	26	DR.425.064	43
DR.301.010	36	DR.3023.00	27	DR.3051.55	26	DR.3063.20	26	DR.425.067	42
DR.301.020	36	DR.3023.10	27	DR.3051.60	26	DR.3063.25	26	DR.426.561	35
DR.3011.00	26	DR.3023.15	27	DR.3051.70	26	DR.3063.30	26	DR.426.567	42
DR.3011.01	26	DR.3023.20	27	DR.3051.80	26	DR.3063.35	26	DR.426.780	41
DR.3011.08	26	DR.3023.25	27	DR.3052.00	26	DR.3063.40	26	DR.426.781	35
DR.3011.10	26	DR.3023.30	27	DR.3052.01	26	DR.3063.45	26	DR.426.784	43
DR.3011.15	26	DR.3023.35	27	DR.3052.10	26	DR.3063.50	26	DR.426.787	42
DR.3011.20	26	DR.3023.40	27	DR.3052.15	26	DR.3063.55	26	DR.431.081	35
DR.3011.25	26	DR.3023.45	27	DR.3052.20	26	DR.3063.60	26	DR.432.070	41
DR.3011.30	26	DR.3031.00	27	DR.3052.25	26	DR.3063.70	26	DR.440.491	35
DR.3011.35	26	DR.3031.15	27	DR.3052.30	26	DR.3063.80	26	DR.440.497	42
DR.3011.40	26	DR.3031.20	27	DR.3052.35	26	DR.3071.00	27	DR.440.790	41
DR.3011.45	26	DR.3031.25	27	DR.3052.40	26	DR.3071.01	27	DR.440.791	35
DR.3011.50	26	DR.3031.30	27	DR.3052.45	26	DR.3071.10	27	DR.440.794	43
DR.3011.55	26	DR.3031.35	27	DR.3052.50	26	DR.3071.15	27	DR.440.797	42
DR.3011.60	26	DR.3031.40	27	DR.3052.55	26	DR.3071.20	27	DR.445.011	35
DR.3011.70	26	DR.3031.45	27	DR.3052.60	26	DR.3071.25	27	DR.445.021	35
DR.3011.80	26	DR.3032.00	27	DR.3052.70	26	DR.3071.30	27	DR.451.011	35
DR.3012.00	26	DR.3032.15	27	DR.3052.80	26	DR.3071.35	27	DR.451.021	35
DR.3012.01	26	DR.3032.20	27	DR.3053.00	26	DR.3071.40	27	DR.452.000	41
DR.3012.08	26	DR.3032.25	27	DR.3053.01	26	DR.3071.45	27	DR.452.005	42
DR.3012.10	26	DR.3032.30	27	DR.3053.10	26	DR.3071.50	27	DR.452.010	41
DR.3012.15	26	DR.3032.35	27	DR.3053.15	26	DR.3071.55	27	DR.452.015	42
DR.3012.20	26	DR.3032.40	27	DR.3053.20	26	DR.3071.60	27	DR.452.020	41
DR.3012.25	26	DR.3032.45	27	DR.3053.25	26	DR.3071.70	27	DR.452.025	42
DR.3012.30	26	DR.3033.00	27	DR.3053.30	26	DR.3071.80	27	DR.452.030	41
DR.3012.35	26	DR.3033.15	27	DR.3053.35	26	DR.3072.00	27	DR.452.035	42
DR.3012.40	26	DR.3033.20	27	DR.3053.40	26	DR.3072.01	27	DR.452.040	41
DR.3012.45	26	DR.3033.25	27	DR.3053.45	26	DR.3072.10	27	DR.452.045	42
DR.3012.50	26	DR.3033.30	27	DR.3053.50	26	DR.3072.15	27	DR.452.050	41
DR.3012.55	26	DR.3033.35	27	DR.3053.55	26	DR.3072.20	27	DR.452.055	42
DR.3012.60	26	DR.3033.40	27	DR.3053.60	26	DR.3072.25	27	DR.452.060	41
DR.3012.70	26	DR.3033.45	27	DR.3053.70	26	DR.3072.30	27	DR.452.065	42
DR.3012.80	26	DR.3041.00	27	DR.3053.80	26	DR.3072.35	27	DR.452.070	41
DR.3013.00	26	DR.3041.15	27	DR.3061.00	26	DR.3072.40	27	DR.452.074	43
DR.3013.01	26	DR.3041.20	27	DR.3061.01	26	DR.3072.45	27	DR.452.075	42
DR.3013.08	26	DR.3041.25	27	DR.3061.10	26	DR.3072.50	27	DR.452.080	41
DR.3013.10	26	DR.3041.30	27	DR.3061.15	26	DR.3072.55	27	DR.452.084	43
DR.3013.15	26	DR.3041.35	27	DR.3061.20	26	DR.3072.60	27	DR.452.085	42
DR.3013.20	26	DR.3041.40	27	DR.3061.25	26	DR.3072.70	27	DR.452.090	41
DR.3013.25	26	DR.3041.45	27	DR.3061.30	26	DR.3072.80	27	DR.452.094	43
DR.3013.30	26	DR.3042.00	27	DR.3061.35	26	DR.3073.00	27	DR.452.095	42
DR.3013.35	26	DR.3042.15	27	DR.3061.40	26	DR.3073.01	27	DR.452.100	41
DR.3013.40	26	DR.3042.20	27	DR.3061.45	26	DR.3073.10	27	DR.452.104	43
DR.3013.45	26	DR.3042.25	27	DR.3061.50	26	DR.3073.15	27	DR.452.105	42
DR.3013.50	26	DR.3042.30	27	DR.3061.55	26	DR.3073.20	27	DR.452.110	41
DR.3013.55	26	DR.3042.35	27	DR.3061.60	26	DR.3073.25	27	DR.452.114	43
DR.3013.60	26	DR.3042.40	27	DR.3061.70	26	DR.3073.30	27	DR.452.115	42
DR.3013.70	26	DR.3042.45	27	DR.3061.80	26	DR.3073.35	27	DR.452.120	41
DR.3013.80	26	DR.3043.00	27	DR.3062.00	26	DR.3073.40	27	DR.452.124	43
DR.3021.00	27	DR.3043.15	27	DR.3062.01	26	DR.3073.45	27	DR.452.125	42
DR.3021.10	27	DR.3043.20	27	DR.3062.10	26	DR.3073.50	27	DR.457.011	35
DR.3021.15	27	DR.3043.25	27	DR.3062.15	26	DR.3073.55	27	DR.457.021	35
DR.3021.20	27	DR.3043.30	27	DR.3062.20	26	DR.3073.60	27	DR.457.031	35
DR.3021.25	27	DR.3043.35	27	DR.3062.25	26	DR.3073.70	27	DR.457.041	35
DR.3021.30	27	DR.3043.40	27	DR.3062.30	26	DR.3073.80	27	DR.458.011	35
DR.3021.35	27	DR.3043.45	27	DR.3062.35	26	DR.370.260	46	DR.458.031	35
DR.3021.40	27	DR.3051.00	26	DR.3062.40	26	DR.370.270	46	DR.458.041	35
DR.3021.45	27	DR.3051.01	26	DR.3062.45	26	DR.370.280	46	DR.459.011	35
DR.3022.00	27	DR.3051.10	26	DR.3062.50	26	DR.370.290	46	DR.460.050	41
DR.3022.10	27	DR.3051.15	26	DR.3062.55	26	DR.370.780	46	DR.460.051	35
DR.3022.15	27	DR.3051.20	26	DR.3062.60	26	DR.370.800	46	DR.460.054	43
DR.3022.20	27	DR.3051.25	26	DR.3062.70	26	DR.425.011	35	DR.463.000	41
DR.3022.25	27	DR.3051.30	26	DR.3062.80	26	DR.425.014	43	DR.463.001	35
DR.3022.30	27	DR.3051.35	26	DR.3063.00	26	DR.425.017	42	DR.463.004	43

Code Index Indice Per Codice

Code/Codice	Page/Pagina	Code/Codice	Page/Pagina	Code/Codice	Page/Pagina	Code/Codice	Page/Pagina	Code/Codice	Page/Pagina
DR.463.005	42	DR.584.231	28	DR.805.010	51	DR.906.530	52	DS.003.020	84
DR.463.007	42	DR.586.020	32	DR.805.020	51	DR.906.550	52	DS.003.030	84
DR.463.010	41	DR.587.030	32	DR.805.030	51	DR.906.560	52	DS.003.040	84
DR.463.011	35	DR.587.040	32	DR.806.010	51	DR.906.590	52	DS.004.010	84
DR.463.014	43	DR.587.050	32	DR.806.020	51	DR.906.600	52	DS.055.010	101
DR.463.015	42	DR.587.060	32	DR.808.020	51	DR.907.000	52	DS.055.020	101
DR.463.017	42	DR.587.130	32	DR.808.040	51	DR.907.001	52	DS.070.010	101
DR.463.020	41	DR.590.014	29	DR.808.050	51	DR.907.020	52	DS.070.020	101
DR.463.021	35	DR.590.024	29	DR.808.060	51	DR.907.021	52	DS.100.010	99
DR.463.024	43	DR.594.013	29	DR.808.070	51	DR.907.070	52	DS.100.014	98
DR.463.025	42	DR.594.014	29	DR.810.101	51	DR.907.080	52	DS.100.015	99
DR.463.027	42	DR.594.023	29	DR.810.102	51	DR.907.081	52	DS.100.020	99
DR.513.031	35	DR.594.024	29	DR.820.170	51	DR.907.140	52	DS.100.024	98
DR.518.010	41	DR.594.033	29	DR.829.050	51	DR.907.141	52	DS.100.025	99
DR.518.020	41	DR.594.034	29	DR.830.085	51	DR.907.211	52	DS.100.030	99
DR.518.030	41	DR.594.043	29	DR.830.086	51	DR.907.212	52	DS.100.034	98
DR.527.014	48	DR.594.044	29	DR.830.087	51	DR.926.170	53	DS.100.035	99
DR.532.160	50	DR.596.011	29	DR.830.120	51	DR.928.170	53	DS.100.040	99
DR.539.010	50	DR.596.021	29	DR.830.121	51	DR.929.170	53	DS.100.044	98
DR.549.000	49	DR.596.031	29	DR.832.010	51	DR.931.170	53	DS.100.045	99
DR.549.001	49	DR.596.041	29	DR.832.020	51	DR.932.170	53	DS.105.010	98
DR.549.002	49	DR.602.013	30	DR.840.010	51	DR.937.000	53	DS.105.020	98
DR.549.003	49	DR.602.014	30	DR.840.020	51	DR.937.010	53	DS.105.030	98
DR.549.004	49	DR.602.023	30	DR.840.030	51	DR.937.020	53	DS.106.010	98
DR.549.010	49	DR.602.024	30	DR.855.010	51	DR.938.130	53	DS.106.020	98
DR.550.000	49	DR.602.033	30	DR.865.014	31	DR.938.150	53	DS.106.030	98
DR.552.000	49	DR.602.034	30	DR.866.014	31	DR.940.160	53	DS.107.010	98
DR.552.001	49	DR.602.043	30	DR.866.024	31	DR.946.160	53	DS.107.020	98
DR.552.002	49	DR.602.044	30	DR.867.000	43	DR.948.000	53	DS.107.030	98
DR.552.003	49	DR.602.053	30	DR.868.000	43	DR.959.008	44	DS.110.850	99
DR.552.004	49	DR.602.063	30	DR.872.001	43	DR.960.008	44	DS.110.855	99
DR.552.010	49	DR.602.073	30	DR.872.005	43	DR.960.011	44	DS.110.860	99
DR.554.000	49	DR.609.060	45	DR.873.017	43	DR.960.014	44	DS.110.865	99
DR.554.001	49	DR.609.140	45	DR.879.014	31	DR.960.018	44	DS.110.870	99
DR.554.002	49	DR.609.170	45	DR.879.024	31	DR.960.021	44	DS.110.875	99
DR.554.003	49	DR.609.180	45	DR.899.010	52	DR.960.024	44	DS.110.880	99
DR.554.010	49	DR.609.190	45	DR.899.020	52	DR.960.028	44	DS.110.885	99
DR.555.000	50	DR.610.170	45	DR.899.030	52	DR.960.031	44	DS.125.010	100
DR.555.001	50	DR.610.180	45	DR.900.000	54	DR.960.034	44	DS.125.020	100
DR.555.002	50	DR.610.190	45	DR.900.001	54	DR.960.038	44	DS.125.040	100
DR.555.010	50	DR.623.000	45	DR.900.002	54	DR.960.048	44	DS.125.050	100
DR.556.000	50	DR.623.004	45	DR.900.004	54	DR.974.038	44	DS.125.060	100
DR.559.000	49	DR.623.010	45	DR.900.005	54	DR.980.027	44	DS.126.044	32
DR.559.001	49	DR.623.014	45	DR.904.010	53	DR.9801.00	201	DS.146.014	32
DR.559.002	49	DR.623.020	45	DR.905.001	52	DR.9810.00	200	DS.146.024	32
DR.559.003	49	DR.623.024	45	DR.905.002	52	DR.9810.01	201	DS.147.014	32
DR.559.010	49	DR.623.030	45	DR.905.003	52	DR.9810.02	200	DS.147.024	32
DR.560.000	49	DR.623.034	45	DR.905.004	52	DR.9810.03	200	DS.198.040	97
DR.570.000	50	DR.623.040	45	DR.905.005	52	DR.9810.04	200	DS.198.050	97
DR.571.000	50	DR.623.044	45	DR.905.006	52	DR.9810.05	200	DS.200.100	100
DR.571.010	50	DR.649.017	46	DR.905.007	52	DR.9810.07	200	DS.200.121	100
DR.571.020	50	DR.649.027	46	DR.905.008	52	DR.9811.01	201	DS.200.330	100
DR.571.030	50	DR.649.037	46	DR.905.009	52	DR.9811.02	201	DS.210.120	100
DR.577.310	28	DR.649.047	46	DR.905.010	52	DR.9811.03	201	DS.220.450	100
DR.577.320	28	DR.650.017	46	DR.905.011	52	DR.9811.04	201	DS.220.640	100
DR.577.330	28	DR.650.027	46	DR.905.012	52	DR.996.005	44	DS.270.190	101
DR.581.017	46	DR.650.037	46	DR.905.013	52	DR.997.020	202	DS.271.190	101
DR.581.027	46	DR.650.047	46	DR.905.014	52	DR.998.010	44	DS.273.010	88
DR.581.037	46	DR.698.010	50	DR.905.015	52	DR.998.020	44	DS.273.190	88
DR.581.047	46	DR.699.010	50	DR.905.016	52	DR.998.030	44	DS.274.010	88
DR.582.010	28	DR.700.010	50	DR.905.017	52	DR.9980.01	202	DS.274.200	88
DR.582.014	28	DR.700.020	50	DR.906.090	52	DR.9980.02	202	DS.375.020	103
DR.582.020	28	DR.799.050	51	DR.906.100	52	DS.002.010	84	DS.389.145	103
DR.582.024	28	DR.799.060	51	DR.906.110	52	DS.002.020	84	DS.405.000	103
DR.584.014	28	DR.799.070	51	DR.906.120	52	DS.002.030	84	DS.405.010	103
DR.584.161	28	DR.800.050	51	DR.906.130	52	DS.002.040	84	DS.416.010	103
DR.584.164	28	DR.800.060	51	DR.906.140	52	DS.002.050	84	DS.416.030	103
DR.584.171	28	DR.800.070	51	DR.906.212	52	DS.003.010	84	DS.423.010	173

Code Index Indice Per Codice

Code/Codice	Page/Pagina	Code/Codice	Page/Pagina	Code/Codice	Page/Pagina	Code/Codice	Page/Pagina	Code/Codice	Page/Pagina
DS.423.030	173	DS.825.075	88	DS.900.048	92	DT.9990.01	184	DZ.085.033	186
DS.424.010	173	DS.826.040	88	DS.910.022	92	DT.9995.01	184	DZ.085.035	186
DS.424.020	173	DS.826.075	88	DS.910.028	92	DZ.050.010	191	DZ.085.039	186
DS.425.010	173	DS.828.250	95	DS.910.035	92	DZ.051.010	191	DZ.090.010	186
DS.425.030	173	DS.830.091	95	DS.910.042	92	DZ.052.010	191	DZ.091.010	186
DS.425.040	173	DS.832.011	95	DS.910.048	92	DZ.055.010	191	DZ.095.010	186
DS.425.050	173	DS.832.015	95	DS.928.040	88	DZ.058.020	191	DZ.095.020	186
DS.425.060	173	DS.838.010	95	DS.928.070	88	DZ.060.010	191	DZ.100.050	186
DS.427.030	103	DS.839.031	95	DS.929.010	87	DZ.060.020	191	DZ.110.050	186
DS.435.010	103	DS.845.010	95	DS.930.022	91	DZ.061.010	191	DZ.200.010	190
DS.435.020	173	DS.845.020	95	DS.930.028	91	DZ.061.020	191	DZ.200.020	190
DS.476.220	104	DS.846.010	95	DS.930.035	91	DZ.061.030	191	DZ.201.010	190
DS.480.220	104	DS.848.020	87	DS.930.042	91	DZ.062.000	191	DZ.2510.000	196
DS.488.014	31	DS.848.040	87	DS.930.048	91	DZ.062.010	191	DZ.390.000	189
DS.488.024	31	DS.850.000	89	DS.935.022	91	DZ.062.020	191	DZ.390.010	189
DS.488.034	31	DS.853.010	89	DS.935.028	91	DZ.062.030	191	DZ.390.020	189
DS.503.100	101	DS.854.000	90	DS.935.035	91	DZ.063.000	191	DZ.390.030	189
DS.508.140	101	DS.854.010	90	DS.935.042	91	DZ.063.010	191	DZ.390.040	189
DS.514.120	102	DS.855.010	89	DS.935.048	91	DZ.063.020	191	DZ.390.050	189
DS.524.120	108	DS.855.020	89	DS.970.010	87	DZ.063.030	191	DZ.390.060	189
DS.525.120	108	DS.855.030	89	DS.970.020	87	DZ.065.010	191	DZ.400.010	187
DS.526.120	108	DS.855.040	89	DT.1180.01	183	DZ.080.000	195	DZ.400.020	187
DS.527.120	108	DS.863.013	90	DT.1180.02	183	DZ.080.001	195	DZ.400.030	187
DS.530.120	107	DS.864.013	90	DT.1180.03	183	DZ.080.010	195	DZ.400.040	187
DS.531.120	107	DS.865.013	90	DT.1180.04	183	DZ.080.020	195	DZ.400.050	187
DS.532.120	107	DS.865.015	90	DT.1180.05	183	DZ.080.030	195	DZ.401.010	187
DS.533.120	107	DS.865.023	90	DT.1180.06	183	DZ.080.050	195	DZ.401.020	187
DS.536.010	108	DS.865.025	90	DT.1180.07	184	DZ.080.080	195	DZ.401.030	187
DS.536.011	107	DS.866.010	89	DT.1180.08	184	DZ.080.090	195	DZ.401.040	187
DS.537.010	108	DS.866.020	89	DT.1185.00	184	DZ.080.110	195	DZ.401.050	187
DS.537.011	107	DS.867.010	90	DT.1200.01	178	DZ.080.130	195	DZ.402.010	187
DS.539.010	108	DS.868.010	90	DT.1200.02	178	DZ.080.150	195	DZ.402.020	187
DS.539.011	107	DS.872.013	93	DT.1201.01	178	DZ.080.170	195	DZ.405.010	188
DS.540.160	107	DS.872.015	93	DT.1201.02	178	DZ.080.180	195	DZ.405.020	188
DS.541.160	107	DS.872.023	93	DT.1205.01	178	DZ.081.000	195	DZ.405.030	188
DS.560.120	107	DS.872.025	93	DT.1205.02	178	DZ.081.001	195	DZ.405.040	188
DS.561.120	107	DS.872.033	93	DT.1210.00	179	DZ.081.010	195	DZ.405.050	188
DS.570.130	107	DS.872.035	93	DT.1220.00	179	DZ.081.020	195	DZ.406.010	188
DS.571.130	107	DS.872.043	93	DT.1225.00	179	DZ.081.030	195	DZ.406.020	188
DS.596.120	106	DS.872.045	93	DT.1250.00	179	DZ.081.050	195	DZ.406.030	188
DS.597.120	106	DS.872.053	93	DT.1251.00	179	DZ.081.080	195	DZ.406.040	188
DS.600.130	106	DS.872.055	93	DT.1275.00	180	DZ.081.090	195	DZ.406.050	188
DS.601.130	106	DS.872.063	93	DT.1276.00	180	DZ.081.110	195	DZ.407.010	188
DS.631.015	120	DS.872.065	93	DT.1285.00	180	DZ.081.130	195	DZ.407.020	188
DS.631.030	120	DS.872.073	93	DT.1300.01	181	DZ.081.150	195	DZ.408.010	188
DS.631.040	120	DS.872.075	93	DT.1303.02	181	DZ.081.170	195	DZ.408.020	188
DS.631.050	120	DS.872.083	93	DT.1303.03	181	DZ.081.180	195	DZ.410.010	188
DS.635.010	120	DS.872.085	93	DT.1303.04	181	DZ.083.010	189	DZ.410.020	188
DS.635.020	120	DS.873.013	94	DT.1303.05	181	DZ.083.020	189	DZ.410.030	188
DS.650.160	120	DS.873.015	94	DT.1305.01	181	DZ.083.030	189	DZ.410.040	188
DS.800.010	87	DS.873.023	94	DT.1305.02	181	DZ.083.040	189	DZ.410.050	188
DS.800.013	87	DS.873.025	94	DT.1305.03	181	DZ.083.050	189	DZ.411.020	188
DS.803.010	87	DS.873.033	94	DT.1305.04	181	DZ.083.060	189	DZ.415.010	188
DS.804.010	87	DS.873.035	94	DT.1305.05	181	DZ.084.010	189	DZ.415.020	188
DS.804.020	87	DS.873.043	94	DT.1315.01	182	DZ.084.020	189	DZ.415.030	188
DS.804.030	87	DS.873.045	94	DT.1315.02	182	DZ.084.030	189	DZ.415.040	188
DS.804.040	87	DS.873.053	94	DT.1316.01	182	DZ.084.040	189	DZ.420.010	189
DS.804.050	87	DS.873.055	94	DT.1316.02	182	DZ.084.050	189	DZ.420.020	189
DS.812.060	88	DS.873.063	94	DT.1320.01	182	DZ.084.060	189	DZ.420.030	189
DS.813.030	88	DS.873.065	94	DT.1320.02	182	DZ.085.010	186	DZ.420.031	189
DS.813.040	88	DS.873.073	94	DT.1400.01	182	DZ.085.013	186	DZ.420.040	189
DS.813.060	88	DS.873.075	94	DT.1401.01	182	DZ.085.015	186	DZ.420.050	189
DS.813.080	88	DS.873.083	94	DT.1401.02	182	DZ.085.019	186	DZ.421.010	189
DS.814.030	88	DS.873.085	94	DT.1401.03	182	DZ.085.020	186	DZ.421.020	189
DS.814.040	88	DS.900.022	92	DT.1401.04	182	DZ.085.023	186	DZ.421.030	189
DS.814.060	88	DS.900.028	92	DT.1403.01	182	DZ.085.025	186	DZ.425.010	188
DS.814.080	88	DS.900.035	92	DT.1403.02	182	DZ.085.029	186	DZ.425.020	188
DS.825.040	88	DS.900.042	92	DT.1403.03	182	DZ.085.030	186	DZ.425.030	188

Code/Codice	Page/Pagina	Code/Codice	Page/Pagina	Code/Codice	Page/Pagina	Code/Codice	Page/Pagina
DZ.425.040	188	DZ.574.010	192	FD.966.180	86	JG.515.090	190
DZ.430.000	187	DZ.575.010	192	FD.967.180	86	JG.520.090	190
DZ.430.010	187	DZ.580.010	192	FD.968.180	86	JG.520.100	190
DZ.430.020	187	DZ.8505.01	195	FK.120.055	97	JG.521.125	190
DZ.430.030	187	DZ.8505.02	195	FK.300.050	97	JG.521.150	190
DZ.430.040	187	DZ.8505.03	195	FK.814.000	100	JG.522.200	190
DZ.430.070	187	DZ.8505.04	195	FK.814.010	100	JG.799.110	190
DZ.430.071	187	DZ.8510.00	195	FK.814.020	100	JG.799.150	190
DZ.430.080	187	DZ.8619.05	202	FL.034.010	101	JG.820.270	190
DZ.430.090	54	DZ.8620.04	202	FL.035.190	101	JG.830.200	190
DZ.430.100	54	DZ.8621.02	202	FL.036.185	101	JG.830.300	190
DZ.431.000	187	DZ.9000.01	195	FL.037.010	101	JG.950.100	194
DZ.432.000	187	DZ.9000.02	195	FL.173.030	101	OC.020.100	110
DZ.435.010	188	DZ.9000.03	195	FL.174.040	101	OC.021.100	110
DZ.435.020	187	DZ.9000.04	195	FL.175.050	101	OC.024.100	110
DZ.455.010	202	DZ.945.020	196	FL.176.060	101	OC.025.100	110
DZ.456.010	202	DZ.945.050	196	FL.213.030	101	OC.483.120	108
DZ.465.000	190	DZ.970.010	196	FL.214.040	101	OC.484.120	108
DZ.467.000	190	DZ.972.100	196	FL.215.050	101	OC.495.120	108
DZ.470.000	190	DZ.972.140	196	FL.216.060	101	OL.219.150	103
DZ.525.010	194	DZ.9880.03	196	FO.409.125	102	OL.610.150	120
DZ.525.020	194	DZ.9883.01	196	FO.409.140	102	OL.611.180	120
DZ.525.030	194	DZ.9885.02	196	FO.412.150	102	OL.612.180	120
DZ.525.040	194	DZ.9889.01	196	FO.413.010	102	OM.001.010	104
DZ.525.050	194	DZ.995.000	196	FO.413.020	102	OM.002.020	104
DZ.530.010	194	DZ.9950.00	195	FO.414.010	102	OM.003.030	104
DZ.532.000	194	FB.396.150	110	FO.415.150	102	OM.019.000	104
DZ.535.010	194	FB.397.150	110	FO.416.150	102	OM.019.010	104
DZ.535.020	194	FB.400.160	110	FO.417.145	102	OM.019.030	104
DZ.535.030	194	FB.401.160	110	FO.455.165	102	OM.030.130	104
DZ.535.040	194	FD.100.150	86	FO.514.180	102	OM.038.100	104
DZ.535.050	194	FD.101.150	86	FO.603.150	101	OM.040.110	104
DZ.540.010	194	FD.242.150	86	GF.920.010	120	OM.041.140	104
DZ.540.020	194	FD.243.150	86	GF.920.020	120	OM.048.160	104
DZ.544.010	194	FD.246.180	86	GF.920.030	120	OM.049.190	104
DZ.555.000	192	FD.247.180	86	GF.920.040	120	OM.202.145	104
DZ.556.000	192	FD.250.180	86	GL400AL	198	OM.205.180	104
DZ.560.010	193	FD.251.180	86	GL400AM	198	OM.208.190	104
DZ.561.012	193	FD.252.180	86	GL400AS	198	OM.236.140	104
DZ.561.015	193	FD.258.010	86	GL400AXL	198	OM.237.150	104
DZ.561.022	193	FD.258.020	86	GL400AXS	198	OM.251.120	103
DZ.561.025	193	FD.258.030	86	GL400L	198	OM.253.140	103
DZ.561.110	193	FD.258.040	86	GL400M	198	OM.254.150	103
DZ.561.111	193	FD.259.010	86	GL400S	198	OM.258.200	103
DZ.561.120	193	FD.259.020	86	GL400XL	198		
DZ.561.121	193	FD.259.030	86	GL400XS	198		
DZ.564.000	192	FD.259.040	86	GL801AL	199		
DZ.564.010	192	FD.284.150	85	GL801AM	199		
DZ.564.020	192	FD.285.150	85	GL801AS	199		
DZ.565.010	193	FD.286.180	85	GL801AXS	199		
DZ.565.020	193	FD.287.180	85	GL801L	199		
DZ.565.030	193	FD.288.150	85	GL801M	199		
DZ.565.040	193	FD.288.180	85	GL801S	199		
DZ.565.050	193	FD.289.150	85	GL801XS	199		
DZ.565.060	193	FD.289.180	85	JG.030.100	190		
DZ.565.210	193	FD.908.150	85	JG.030.125	190		
DZ.565.211	193	FD.909.150	85	JG.035.125	190		
DZ.565.220	193	FD.910.180	85	JG.035.150	190		
DZ.565.221	193	FD.911.180	85	JG.500.030	189		
DZ.567.010	193	FD.920.180	85	JG.500.050	189		
DZ.569.010	193	FD.930.145	85	JG.500.090	189		
DZ.569.020	193	FD.930.185	85	JG.503.150	190		
DZ.572.010	192	FD.931.145	85	JG.503.180	190		
DZ.572.050	192	FD.931.185	85	JG.504.200	190		
DZ.572.100	192	FD.950.140	85	JG.506.250	190		
DZ.573.000	192	FD.951.140	85	JG.515.020	190		
DZ.573.010	192	FD.960.155	86	JG.515.040	190		
DZ.573.020	192	FD.961.155	86	JG.515.060	190		

Descriptive Index

A	Page	Page	Page
Abrasive Strips	145	Boley Gauges	134
Accessories For Ultrasonic Tips	16,84	Bone Block Clamps	89
Adams/Wescott Burnishers	34,39,40	Bone Chisels	101
Adams Pliers Wire Bending	167	Bone Collectors	90
Aderer Pliers Loop Forming/Bending	172	Bone Curettes	98-100
Aderer Pliers Wire Bending	155,164,169	Bone Cutters	101
Adhesive Removers	146	Bone Files	100
Adson Forceps Dissecting	110	Bone Gouges	101
Adson Forceps Tissue	110	Bone Graft Compactors	90
Adson Bone-Beaks Forceps Tissue	111	Bone Grafting Applicators	90
Adson-Fraser Forceps Haemostatic	113	Bone Injectors	89
Adson-Micro Forceps Dissecting	110	Bone Mallets	88,101
Adson-Micro Forceps Tissue	110	Bone Mill	89
Ainsworth Punches Rubber Dam	53	Bone Rongeurs	101,102
Albrecht Tweezers Extraction	82	Bone Tampers	88
Alcohol Burners	132	Bone Thickness Gauges	87
Alginate Bowls	135	Bone Well	89
Alginate Spatulae	136,137	Boone Gauges Bracket Positioning	146
Allen Elevators Implant Periosteal	95	Bottles Glass For Medicines	195
Alm Retractors Self-Retaining	120	Bow Divider Orthodontic	144
Allocare Gloves	198	Bowls Alginate	135
Amalgam Carriers	36	Bowls Plaster	135
Amalgam Carriers Micro	36	Bowls Stainless Steel	190
Amalgam Pluggers	34,37,38	Boxes Endodontic	192-193
Amalgam Well	36	Boxes Instruments Stainless Steel	190
Anaesthesia Syringes	55-62	Boynlon Needle Holders	117
Angel Pliers Wire Bending	155,163,168	Bracket Placing Tweezers	146
Anvil	134	Bracket Positioning Gauges	146
Apical Elevators	67	Brass Series Syringes	60,61
Applicator For Medicaments	43	Brewer Forceps Rubber Dam Clamps	53
Applicators Bone Grafting Material	90	Bruenings Depressors Tongue	104
Applicators Elastomeric Ligature	147	Buccal Tube Placing Tweezers	145
Applicators For Calcium Hydroxide	43	Burners Alcohol	132
Applicators Micro Disposable	202	Burnishers	34,39,40
Arch Contouring Pliers	155	Burs Disinfecting Boxes	191
Articulating Paper Forceps	50	Burs Holders and Stands	191
Articulators	132,133	Burs Tungsten Carbide HP	141,142
Atraumatic Forceps	110	Busar Elevators Implant Periosteal	95
Austin Retractors Cheek	103	Buttons Silicone For Impression Trays	130
B			
Backhaus Forceps Towel	112	C	
Baldwin Filling Instruments	41-43	Calipers Laboratory	134
Band Pushers	145	Carvers Amalgam	47
Band Seaters	145	Carvers For Silicone Impression Material	123
Bandage Scissors	109	Carvers Laboratory	139,140
Bands Matrix	51	Cases For Impression Tray Shipping	130
Baumgartner Needle Holders	115,116	Cases For Models Shipping	130
Beale Carvers Modeling	139	Cases Retainer	174
Beavertail Burnishers	39	Cassette Trays	186,189
Bee Bee Scissors Crown	134	Castroviejo Bone Thickness Gauges	87
Beerendonk Vernier Caliper	144	Castroviejo Needle Holders	114,116
Bein Elevators	66,67,69,70	Caltoni Probes Periodontal	5
Benders Distal Wires	148	Cavity Preparation Instruments	46
Bernhard Elevators	66	Cawood-Minnesota Retractors Cheek	103
Bernklau Rulers	144	Cement Spatulae	44
Beyer Rongeurs Bone	102	Century-Line Elevators	65,66
Bib Holders/Chains	196	Century-Line Implantology Instruments	87-95
Bite Gauge	123	Ceramic Sculpturing Instruments	138
Bite Sticks	145	Cheafe Forceps Sterilizing	190
Black Amalgam Pluggers	34,38	Cheek and Lip Retractors	103,173
Blacks Margin Trimmers	46	Chisels Bone	101
Blade Removing Forceps	105	Chisels Periodontal	20
Blades For Laboratory Saws	135	Chompret Syndesmotomes	73
Blades Scalpel	105	Clamp Matrix Strip	51
Blades Scalpel Micro	85	Clamps Bone Block	89
Blumenthal Rongeurs Bone	102	Cleoid-Discoid	48
Boghossian Filling Instruments	35	Cleveland Cutters Bone	101
		Coleman Elevators	71
		Collectors Bone	90
		College Tweezers	12
		College-TOE Tweezers	12
		Collin Forceps Sterilizing	190
		Color Code Rings	195
		Columbia Curettes	20
		Columbia Retractors Cheek	103
		Compactors Bone Graft	90
		Compo-Fill Instruments	34,35
		Condensing Osteotomes	91
		Coon Pliers Ligature Tying	150
		Cotton Holders and Dispensers	194
		Coupland Elevators	66,68
		Crane-Kaplan Scalers	21-23
		Crile Forceps Haemostatic	113
		Crile-Rankin Forceps Haemostatic	113
		Crilewood Needle Holders	115,116
		Crown Forceps	50,134
		Crown Instruments	49,50,134
		Crown Pliers	50,134
		Crown Removers	49,50
		Crown Scissors	134
		Crown Spreaders	50
		Cryer Elevators	66,68
		Curettes Bone	98-100
		Curettes Endodontics	32
		Curettes Periodontal	17-20
		Curettes Sinus Lift	93
		Cutters Bone	101
		Cutters Distal End	153,160,161
		Cutters Ligature	154,160,161
		Cutters Plaster	135
		Cutters Wire	153,154,161,162,166
D			
		Dappen Pots Glass	195
		Darby Perry Scalers	24
		De Bakkey Forceps Atraumatic	110
		De La Rosa Pliers Arch Contouring	155
		Deflectors Tongue	120
		DENTALINE Disposable spatulae	202
		DENTALINE Impression Trays Disposable	124
		DENTALINE Intraoral Tips Disposable	201
		DENTALINE Mixing Tips	200-201
		DENTALINE Syringe Impression Disposable	201
		DENTALINE Tips For Etching Gel Disposable	202
		DENTALINE Tips For Flowable Composites	202
		Depressors Tongue	104
		Derf Needle Holders	115,116
		Diagnostic Instruments	1-14
		Disc Safety Guard Set	145
		Disc-System Syringes Self Aspirating	57,59,60
		Disinfecting Boxes For Burs	191
		Dispensers Bibs	196
		Dispensers Cotton	194
		Dispensers Drinking Cup	190
		Dispensers Orthodontics	176
		Disposable Instrument Trays	202
		Disposable Products	197-202
		Disposable Scalpels	105
		Dissecting Forceps	110,111
		Distal End Cutters	153,160,161
		Distal Wire Benders/Pliers	148,156,164
		D-Lite Illuminated Mouth Mirror	7
		Dolphin Pliers Universal	171
		Dressing Forceps	112
		Dynamometers	144

Descriptive Index

	Page		Page		Page
Hemingway Curettes Bone	98,99	L		Micro Torches	132
Hilger Retractors Cheek	103	Laboratory Instruments	131-142	Middeldorp Retractors	119
Hirschfield Elevators Periosteal	96	Laboratory Pliers	166-172	Mill Bone	89
Hoes	20	Ladmore Burnishers	34,39	Miller Files Bone	100
Holders Burs	191	Ladmore Tongue Deflectors	120	Miller Forceps For Articulating Paper	50
Hollenback Amalgam Pluggers	34	LaGrange Scissors	106-108	Minnesota Retractors Cheek	103
Hollenback Carvers	47	Langenbeck Retractors	119	Mirrors Dental	7,8
Hollow Chop Pliers Arch Forming Falcon	164	Lecluse Elevators	72	Mirrors Photographic	10,11
Hooks Skin	120	Lecron Carvers Modeling	139,140	Mixing Tips	200-201
Hopkins Elevators Periosteal	96	Lecron-Mini Carvers Modeling	140	Model Base Formers	130
How Pliers Utility	157,163	Lessmann Knives Wax	137	Modeling Carvers And Spatulae	139,140
Howard Files Bone	100	Lichtenstein Spatulae Plaster	136	Molt Curettes Bone	100
Hygienist Scalers	21-24	Ligature Cutters	154,160,161	Molt Elevators Periosteal	96
Hylin Carvers Modeling	139,140	Ligature Scissors	109	Molt Endodontic Curettes	32
Hylin Ceramica Carvers Modeling	140	Ligature Tuckers / Directors	147	Molt Mouth Gags	104
Hylin Elevators	70	Lindo-Levian Elevators	70	Mortar And Pestle	195
Hylin-Falcon Carvers Modeling	140	Lip and Cheek Retractors	103,173	Mosquito Forceps Haemostatic	113
Hylin-Lecron Carvers Modeling	140	Lister Scissors Bandage	109	Mosquito-Micro Forceps Haemostatic	113
I		Littauer Scissors Ligature	109	Mouth Gags	104
ID-Color Impression Trays	125	Locklin Scissors	107	Mouth Mirror Handles	8
ID-Color Silicone Buttons	130	London Hospital Elevators	71	Mouth Mirrors	7,8
Implant Osteotomes	88	Lucas Curettes Bone	98,99	Mouth Mirrors Chrome	8
Implant Periosteal Elevators	95	Luer Rongeurs Bone	102	Mouth Mirrors Front Surface	8
Implant Retractors	87	Luxators	65,67	Mouth Mirrors Illuminated	7
Implantology Instruments	87	M		Mouth Mirrors Magnifying	8
Impression Accessories	121-130,200-201	Magnum Pliers Universal	172	Mouth Mirrors Micro	8
Impression Trays Aluminum	125-129	Mall Amalgam Pluggers	37	Mouth Mirrors Perfection Model	8
Impression Trays Disposable	124	Mallets Bone	88,101	Mouth Mirrors Plane	8
Impression Trays Stainless Steel	125-129	Mallets Riveting	134	Mouth Mirrors Rhodium	8
Injectors Bone	89	Manual Aspirating Syringes	57-61	Mouth Props	104
Instrument Trays	187-189	Margin Trimmers	46	N	
Interdental Stripper Handle	145	Markley Amalgam Pluggers	37,38	Nabers Probes Periodontal	5
Intraligamental Syringes	56,60	Maryland Moffit Probes Periodontal	6	Nance Pliers For Forming Adam Clasps	170
Intraoral Photographic Mirrors	10,11	Mathieu Needle Holders	115,117	Nance Pliers Loop Forming /Bending	157,165
Iris Forceps Dissecting	110	Mathieu-Kocher Needle Holders	115,117	Needle Cases	117
Iris Forceps Tissue	110	Matrix Bands	51	Needle Holders	114-117
Iris Scissors	106-108	Matrix Forceps	51	Needle Holders Micro	85,86
IV Forceps Rubber Dam Clamps	53	Matrix Retainers	51	Needle Re-cappers	62
IV Punches Rubber Dam	53	Matrix Strip Clamp	51	NiTi Endodontic Instruments	26
Ivory Bands Matrix	51	Mayo Scissors	109	Nifi Ice Instruments	148
Ivory Retainers Matrix	51	Mayo-Hegar Needle Holders	115,116	Noyes/Castroviejo Scissors	108
Iwanson Calipers	134	McFarlane Hoes	20	Nyström Bands Matrix	51
J		McFarlane Scalers	21	Nyström Retainers Matrix	51
Jacquette Scalers	21-24	Mckellops Pliers Loop Forming /Bending	170	O	
Jacquette-Towner Scalers	22,23	Mead Mallets Bone	101	Obwegeser Retractor Ramus	104
Jarabak Pliers Wire Bending	157,164	Mead Rongeurs Bone	102	Obwegeser Retractor Spina-Nasalis	104
Jars Forceps	190	Mead/West Elevators Periosteal	96	Occlusor	132
Johnson Pliers Band Contouring	151	Meissner Forceps Extraction	82	Ochsenbein Chisels Bone	101
Jones Forceps Towel	112	Membrane Placement Instruments	90	Ohl Elevators Periosteal	97
K		Meriam Tweezers	12	Olsen-Hegar Needle Holders	115,116
Keat Tweezers Buccal Tube Placing	145	Merrit Probes Periodontal	6	Omega Pliers Loop Forming /Bending	158
Kelly Forceps Haemostatic	113	Mershon Band Pushers	145	Orban Knives Gingivectomy	97
Kelly Scissors	106-108	Metzenbaum Scissors	106,108	Organizers Orthodontics	175-176
Kelly-Rankin Forceps Haemostatic	113	Metzenbaum-Delicate Scissors	109	Oringer Lip and Cheek Retractors	103
Kilner Hooks Skin	120	Michigan Probes Periodontal	5,6	Orthodontics Instruments	143-176
Kilner Retractors Cheek	103	Micro Amalgam Carriers	36	Orthodontics Pliers	147-165
Kirkland Knives Gingivectomy	97	Micro Applicators Disposable	202	Osteotomes	101
Knives Finishing	47,48	Micro Endodontic Applicators	31	Osteotomes Bone Condensing	91
Knives Gingivectomy	97	Micro Endodontic Forceps	32	Osteotomes Implant	88
Knives Plaster	136	Micro Forceps Dissecting	85	Osteotomes Sinus Lift	92
Knives Wax	137	Micro Forceps Tissue	85	P	
Kocher Forceps Haemostatic	113	Micro Forceps Tissue	85	P.K. Thomas Instruments	138,139
Kocher Retractors	119	Micro Forceps Watchmaker	111	Parker-Langenbeck Retractors	118
Kocher-Delicate Forceps Haemostatic	113	Micro Instruments	85,86	Paritsch Chisels Bone	101
		Micro Mouth Mirrors	8	Paritsch Gouges Bone	101
		Micro Needle Holders	85,86		
		Micro Pluggers/Burnishers For Endodontics	30		
		Micro Scalpel Blades	85		
		Micro Scissors	86		

	Page		Page		Page
Parsch Mallets Bone	101	Racks For Instruments	187-189	Separators Placing Pliers	149
Pean Forceps Haemostatic	113	Racks For Pliers	175-176	Sets Rubber Dam Instruments	54
Peeso Pliers Contouring	168	Racks For Trays	187-189	Silver Points Forceps	32
Peeso Pliers Wire Bending	168	Ramus Retractors	104	Simplex Retractors Cheek	103
Peet Splinter Forceps	32	Real Series Dental Models	177-182	Sinus Lift Curettes	93
Perfection Model Mouth Mirrors	8	Reamers Endodontics	27	Sinus Lift Elevators	94
Perforation Repair Instruments	31	Remover Elastomeric Ligature	147	Sinus Lift Osteotomes	92
Periodontal Chisels	20	Removers Crown	49,50	Sinus Rongeurs	87
Periodontal Curettes	17-20	Restorative Instruments	33-54	Skin Hooks	120
Periodontal Instruments	15-24	Retainer Cases	174	Skin Retractors	118,120
Periodontal Probes	5,6	Retainers Matrix	51	Smaha Pliers Ligature Tying	150
Periosteal Elevators	96,97	Retractors Endodontic	31	Soffflex Nitrile Gloves	199
Periotomes	95	Retractors Gum Flap	145	Soft-Grip Pliers	160
Perry Tweezers	12	Retractors Implant	87	SOFT-LINE Curettes Bone	98
Pichard Elevators Implant Periosteal	95	Retractors Lip and Cheek	103,173	SOFT-LINE Endodontic Instruments	28-32
Pichard Elevators Periosteal	96	Retractors Ramus	104	SOFT-LINE Explorers	2,4
Pistol-Ject Syringes Intraligamental	56,60	Retractors Self-Retaining	120	SOFT-LINE Filling Instruments	38,40,43,44,45,47
P-Ject Syringes Manual Aspirating	60	Retractors Spina-Nasalis	104	SOFT-LINE Impression Instruments	123
Placement Instruments for Membrane	90	Retractors Tissue And Skin	118,120	SOFT-LINE Laboratory Instruments	139
Plaster Bowls	135	Reynolds Pliers Band Contouring	151	SOFT-LINE Mirror Handles	9
Plaster Cutters	135	Rings Color Coding	195	SOFT-LINE Orthodontic Instruments	145-148
Plaster Knives	136	Riveting Mallets	134	SOFT-LINE Periodontal Instruments	18,21
Plaster Saws	135	Roach Carvers Modeling	139	SOFT-LINE Probes Periodontal	6
Plaster Spatulae	136	Rochester-Pean Forceps Haemostatic	113	Soldering Tweezers	135
Plastic protection tube	56	Roghe Spatulae Plaster	136	Spatulae Alginate	136,137
Pliers Adhesive Removing	162	Rongeurs Bone	101,102	Spatulae Cement	44
Pliers Arch Contouring	155	Rongeurs Sinus	87	Spatulae Disposable	202
Pliers Arch Forming	156,164,165	Roser-König Mouth Gags	104	Spatulae Plaster	136
Pliers Arrow Clasp Forming/Bending	170	Routurier Forceps Extraction	82	Spencer Scissors Ligature	109
Pliers Band Removing	151,160,162	Rubber Dam Clamp Forceps	53	Spina-Nasalis Retractors	104
Pliers Band Sealing	151	Rubber Dam Clamps	52	Splinter Forceps	32,111
Pliers Bracket Removing	152,160,162	Rubber Dam Clamps Tray	53	Sponge Forceps	112
Pliers Buccal Tube Convertible Cap Removing	152	Rubber Dam Frames	53	Spreaders Crown	50
Pliers Contouring	151,168	Rubber Dam Instruments	52-54	Spreaders Endodontics	27,30
Pliers Crown	50	Rubber Dam Instruments Sets	54	SS-2000 Syringes	56-58
Pliers Detailing Step	165	Rubber Dam Latex	52	Standard Scalers	24
Pliers Distal End Bending (Cinch Back)	156,164	Rubber Dam Punches	53	Standard Scissors	109
Pliers Elastomeric Placing	149	Rubber Dam Template	53	Stands Burs	191
Pliers For Forming Adam Clasps	170	Ruddle Endodontic Curettes	32	Steiner Pliers Ligature Tying	150
Pliers Laboratory	166-172	Rulers	144	Sterilizing And Sundries	183-196
Pliers Ligature Forming	164			Sterilizing Forceps	190
Pliers Ligature Tying	150	S		Sternberg Retractors Cheek	103
Pliers Lingual Arch Forming	155,165	Sacks Knives Plaster	136	Stieglitz Splinter Forceps	111
Pliers Loop Forming /Bending	157,165,169,170,172	Saws Laboratory	135	Stokes Forceps Rubber Dam Clamps	53
Pliers Orthodontics	147-165	Scalers	21-24	Stokes/Palmer Forceps Rubber Dam Clamps	53
Pliers Surgical Ball Hook Crimping	156,165	Scalpel Blades	105	Stones Grinding	196
Pliers Torquing With Key	165	Scalpel Blades Micro	85	Strabismus Scissors	106
Pliers Universal	171,172	Scalpel Handles	105	Strips Abrasive	145
Pliers Utility	157,158,160,163	Scalpels	105	Suction Tubes	120
Pliers V-Bend Forming	165	Scalpels Disposable	105	Super-Cut Scissors	107
Pliers Wire Bending	155-172	Schaedel Forceps Towel	112	Surgery Instruments	83-120
Pluggers Amalgam	34,37,38	Schlemmer Elevators	71	Suture Forceps	120
Pluggers Endodontics	27,29	Schmeckebier Elevators	68	Swedish Micro Vascular Needle Holders	115
Pocket Marking Tweezers	97	Schwarz Pliers Arrow Clasp Forming/Bending	170	Swedish Type Syringes Intraligamental	56,60
Potts Elevators	72	Schwarz Pliers Loop Forming /Bending	169	Swiss Model Amalgam Carrier	36
Probes	120	Scissors	106-109	Syndesmotomes	73
Probes Implant Depth	87	Scissors Bandage	109	Syringes Anaesthesia	55-62
Probes Periodontal	5,6	Scissors Crown	134	Syringes Impression Disposable	201
Projection-System Syringes Self Aspirating	57,59	Scissors Gum	106-109	Syringes Intraligamental	56,60
Protective Glasses	195	Scissors Ligature	109	Syringes Manual Aspirating	57-61
Protectors Finger	104	Scissors Micro	86	Syringes Self Aspirating	57,59,60
Punches Rubber Dam	53	Scissors Operating	106-109		
		Seldin Elevators	68	T	
Q		Seldin Elevators Periosteal	97	Tampers Bone	88
Quatro Syringes Self And Manual Aspirating	57	Self Aspirating Syringes	57,59,60	Tanner Amalgam Pluggers	34
		Semken Forceps Dissecting	110	Tanner Knives Finishing	48
R		Semken Forceps Tissue	110	Taylor Scalers	21-23
Rachets Wrench	87	Senn-Miller Retractors	118	Teaching Aids	177-182

Descriptive Index

	Page
Teeth for Typodonts	182
Template Cephalometric	144
Template Correlometer	144
Template Ricketts	144
Template Rubber Dam	53
Template Tracing	144
TG Periodontal Chisels	20
Tips Intraoral Disposable	201
Tips Mixing Disposable	200-201
Tips Ultrasonic Cavity Preparation	36
Tips Ultrasonic Endodontics	27
Tips Ultrasonic Periodontal	16
Tips Ultrasonic Scaling	16
Tips Ultrasonic Surgery	84
Tissue Forceps	110,111
Tissue Retractors	118,120
Titanium Extraction Forceps	81
Toennis Needle Holders	115
Toffemire Bands Matrix	51
Toffemire Retainers Matrix	51
Tomati Rongeur Bone	102
Tongs	135
Tongue Deflectors	120
Tongue Depressors	104
Torquing Key	148
Towel Forceps	112
Towel Holders/Chains	196
Towner Scalers	24
Tray For Rubber Dam Clamps	53
Trays Cassette	186,189
Trays Endodontic	192
Trays Instruments	187-189
Trays Instruments Disposable	202
Trays Kidney	190
Trio Syringes Self And Manual Aspirating	57
True-Flex Clamps Rubber Dam	52
Tubes Suction	120
Tuckers Ligature	147
Tungsten Carbide Burs HP	141,142
Turrets Arch Forming	148
Tweed Pliers Loop Forming /Bending	158,163,164
Tweed/Angel Pliers Arch Forming	156,165
Tweezers Bracket Placing	146
Tweezers Buccal Tube Placing	145
Tweezers Bur Holding	191
Tweezers Cotton	12
Tweezers Elastomeric Ligature Removing	149
Tweezers Endodontics	32
Tweezers Extraction	82
Tweezers For Membrane Placement	90
Tweezers Pocket Marking	97
Tweezers Soldering	135
Typodont Articulators	182

U

Ultima Needle Re-cappers	62
Ultrasonic Cavity Preparation Tips	36
Ultrasonic Endodontic Tips	27
Ultrasonic Periodontal Tips	16
Ultrasonic Scaling Tips	16
Ultrasonic Surgery Tips	84
Ultrasonic Tips Accessories	16,84
UNC Probes Periodontal	6
UniPress Universal Dispenser	122
Universal Curettes	20
Universal Scissors Bandage	109
University of Minnesota Retractors Cheek	103
USA Model Impression Trays	125-127

	Page
USC Knives Finishing	47

V

Vehe Carvers Modeling	139
Vernier Calipers	144

W

Wakefield Osteotomes	101
Waldsachs Pliers Universal	171
Walter F. Barry Elevators	72
Wards Amalgam Pluggers	37
Wards Carvers	47
Warwick-James Elevators	66,71
Wax Knives	137
Weingart Pliers Utility	158,160,163
Wellman Retractors Self-Retaining	120
Well Amalgam	36
Well Bone	89
Wescott Burnishers	34,39,40
Weston Cement Spatulae	44
White Burnishers	34,40
WHO Probes Periodontal	5,6
Wicks For Alcohol Lamps	132
Wieder Depressors Tongue	104
Wiland Carvers	47
Williams Probes Periodontal	5,6
Williger Curettes Bone	100
Williger Elevators Periosteal	97
Winter Elevators	72
Wire Bending Pliers	155-172
Wire Cutters	153,154,161,162,166
Witzel Forceps Extraction	82
Woodson Filling Instruments	41
Wynman Forceps Crown	50

X

X-Ray Clips	196
X-Ray Hangers	196
X-Ray Illuminators	14
X-Ray Positioners Kits	14

Y

Young Frames Rubber Dam	53
Young Pliers Loop Forming /Bending	170
Younger-Good Scalers	22,23

Z

Zahle Carvers Modeling	139,149
-------------------------------	---------

A	Pagina
Abbassalingua	120
Accessori Per Punte Per Ultrasuoni	16,84
Adom/Wescott Brunitori	34,39,40
Adams Pinze Per Piegare	167
Aderer Pinze Per Anse Chiuse	172
Aderer Pinze Per Piegare	155,164,169
Adson Pinzette Anatomiche	110
Adson Pinzette Chirurgiche	110
Adson-Brown Pinzette Chirurgiche	111
Adson-Fraser Pinze Emostatiche	113
Adson-Micro Pinzette Anatomiche	110
Adson-Micro Pinzette Chirurgiche	110
Aghi Per Composito Fluido	202
Aghi Per Gel Monouso	202
Ainsworth Pinze Per Forare La Diga	53
Albrecht Pinzette Per Estrazione	82
Allen Scollaperiostei Per Implantologia	95
Alm Divaricatori Autostatici	120
Allocare Guanti	198
Anelli Di Identificazione	195
Anestesia-Siringhe	55-62
Angel Pinze Per Piegare	155,163,168
Apical Leve Per Radici	67
Appendiradiografie	196
Applicatori Di Osso Triturato	90
Applicatori Per Legature Elastiche	147
Applicatori Per Micro Endodonzia	31
Applicatori Per Sottofondo	43
Apribocca	104
Apricorone	50
Articolatori	132,133
Articolatori Typodont	182
Ausili Didattici	177-182
Austin Divaricatori Per Guance	103
B	
Backhaus Pinze Per Pannolino	112
Baldwin Strumenti Per Otturazioni	41-43
Base Riponi Ago	62
Basi Per Modelli	130
Baumgartner Porta Aghi	115,116
Beale Strumenti Per Modellare	139
Beavertail Brunitori	39
Bee Bee Forbici Per Corone	134
Beerendonk Calibro	144
Bein Leve Per Radici	66,67,69,70
Bernhard Leve Per Radici	66
Bernklau Righello	144
Beyer Pinze Ossivore Alveolotome	102
Bisturi	105
Bisturi Monouso	105
Bisturi Per Gengivectomia	97
Black Otturatori Per Amalgama	34,38
Blacksr Finitori Per Bordi Gengivali	46
Bumenthal Pinze Ossivore Alveolotome	102
Boghossian Strumenti Per Otturazioni	35
Boley Calibri	134
Boone Calibro Per Posizionamento Attacchi	146
Bottoni In Silicone Per Porta Impronte	130
Boynton Porta Aghi	117
Brass Series Siringhe	60,61
Brewer Pinze Per Uncini	53
Brennings Abbassalingua	104
Brunitori	34,39,40
Busar Scollaperiostei Per Implantologia	95
C	
Calibri	134,144

	Pagina
Calibro Facciale	123
Calibro Per Posizionamento Attacchi	146
Cannule Per Aspirazione	120
Carvers [per modellare e rifinire otturazioni]	47
Cassette' Inox Per Sterilizzare	186,189
Castroviejo Porta Aghi	114,116
Castroviejo Spessimetri Per Osso	87
Catenella Per Mantelline	196
Cattoni Sonde Millimetriche	5
Cawood-Minnesota Divaricatori Per Guance	103
Century-Line Leve	65,66
Century-Line Strumenti Per Implantologia	87-95
Cesioie Per Osso	101
Cesioie Taglia Gesso	135
Chealte Pinze Per Sterilizzazione	190
Chiave Per Torque Linguale	148
Chiavi A Cricchetto	87
Chirurgia-Strumenti	83-120
Chompret Sindesmotomi	73
Cleoidi -Discoidi	48
Cleveland Cesioie Per Osso	101
Coleman Leve Per Radici	71
College Pinzette Per Medicazione	12
College-TOE Pinzette Per Medicazione	12
Collin Pinze Per Sterilizzazione	190
Coltelli Per Cera	137
Coltelli Per Gesso	136
Columbia Curettes	20
Columbia Divaricatori Per Guance	103
Compasso Separatore Ortodontico	144
Compattatori Per Osso	88
Compattatori Per Osso	90
Comp-Fill Strumenti Per Otturazioni	34,35
Conservativa-Strumenti	33-54
Contenitori In Acciaio Inox	190
Contenitori Per Aghi	117
Contenitori Per Disinfettare Le Frese	191
Contenitori Per Endodonzia	192-193
Contenitori Per Frese	191
Contenitori Per Impronte	130
Contenitori Per Modelli	130
Contenitori Per Pinze	190
Coon Pinze Per Legature	150
Coupland Leve Per Radici	66,68
Crane-Kaplan Levatartaro	21-23
Crile Pinze Emostatiche	113
Crile-Rankin Pinze Emostatiche	113
Crilewood Porta Aghi	115,116
Cryer Leve Per Radici	66,68
Cucchiai Alveolari	98-100
Curette sopra-gengivali a "zappa"	20
Curettes Per Endodonzia	32
Curettes Per Parodontologia	17-20
Curettes Per Rialzo Del Seno	93
Curettes Universali	20
D	
Dappen In Vetro	195
Darby Perry Levatartaro	24
De Bakey Pinzette Atraumatiche	110
De La Rosa Pinze Per Contornare Archi	155
DENTALINE Aghi Per Composito Fluido	202
DENTALINE Aghi Per Gel Monouso	202
DENTALINE Portaimpronte Monouso	124
DENTALINE Puntali Miscelatori	200-201
DENTALINE Siringa Monouso Per Impronte	201
DENTALINE Spatoline Monouso	202
DENTALINE Terminali Intraorali Monouso	201

	Pagina
Denti Per Typodont	182
Derf Porta Aghi	115,116
Diagnostica-Strumenti	1-14
Diga In Lattice	52
Dinamometro	144
Direzionatori Di Legature	147
Disc-System Siringhe Autoaspiranti	57,59,60
Dispenser Per Salviette	196
Distributore Per Ortodonzia	176
Distributori Di Bicchieri	190
Distributori Di Cotone	194
Divaricatore Per Lembi Gengivali	145
Divaricatori	118,120
Divaricatori Autostatici	120
Divaricatori Per Endodonzia	31
Divaricatori Per Implantologia	87
Divaricatori Per Labbra e Guance	103,173
Divaricatori Per Spina-Nasale	104
Divaricatori Ramus	104
D-Lite Specchietto Illuminato	7
Dolphin Pinze Universali	171
E	
Easy-Color Strumenti Per Implantologia	87,95
Easy-Color Strumenti Per Otturazioni	34,35
Easy-Color Strumenti Per Parodontologia	17,21
Ehrlicke Mod. Porta Impronte	127,128
Endodonzia-Strumenti	25-32
Ermerl Coltelli Per Cera	137
Escavatori	45,46
Escavatori Endodontici	28
Estrazione-Strumenti	63-82
Euro Siringhe Ad Aspirazione Manuale	58,59,61
Expros (Combinazione Sonde/Sonde millimetriche)	5
F	
Fahnenstock Coltelli Per Cera	137
Falcon Apricorona	50
Falcon Articolatori	133
Falcon Brunitori	39-40
Falcon Calibro	144
Falcon Calibro Facciale	123
Falcon Cannula Per Aspirazione	120
Falcon Cassette' Inox Per Sterilizzare	186
Falcon Cesioie Per Osso	101
Falcon Coltelli Per Gesso	136
Falcon Curettes Per Rialzo Del Seno	93
Falcon Divaricatori Per Guance	103,173
Falcon Divaricatori Per Implantologia	87
Falcon Escavatori	45,46
Falcon Escavatori Endodontici	28
Falcon Forbici	106-108
Falcon Levacorone	49
Falcon Leve Per Radici	65,71
Falcon Luxators	65,67
Falcon Manico per specchi foto intraorali	11
Falcon Martelli Chirurgici	88,101
Falcon Osteotomi Per Implantologia	88
Falcon Otturatori Per Amalgama	37-38
Falcon Otturatori Per Canali	29
Falcon Pinze Per Formare Archi	156
Falcon Pinze Per Formare Archi Linguali	155,165
Falcon Pinze Per Formare Le Legature	164
Falcon Pinze Per Grippare Ganci Chirurgici E Stop	156,165
Falcon Pinze Per La Rimozione Di Attacchi	152,160,162
Falcon Pinze Per La Rimozione Di Bande	151,160,162
Falcon Pinze Per Legature	150
Falcon Pinze Per Matrici	51

Indice Per Descrizione

	Pagina		Pagina		Pagina
Falcon Pinze Per Piegare	155,163,168	Goldman-Fox Pinzette Per Marcare Le Tasche	97	Kit Centratore	14
Falcon Pinze Per Piegare I Distali (Cinch Back)	156,164	Goldman-Fox Scollaperiostei	96	Kocher Divaricatori	119
Falcon Pinze Per Piegatura a Baionetta	165	Goldman-Fox Sonda Millimetriche	5,6	Kocher Pinze Emostatiche	113
Falcon Pinze Per Piegatura a V	165	Goldstein Strumenti Per Otturazioni	35	Kocher-Delicate Pinze Emostatiche	113
Falcon Pinze Per Posizionare Le Bande	151	Gracey Curettes	17-19		
Falcon Pinze Per Rialzo Del Seno	87	Gregg Strumenti Per Otturazioni	35,41,43	L	
Falcon Pinze Per Rimuovere Residui Di Adesivo	162	Griglia Per Strumenti	187-189	La Grange Forbici	106-108
Falcon Pinze Per Togliere I Tappi Dei Tubetti Buccali	152	Grifman Coltelli Per Gesso	136	Laboratorio-Strumenti	131-142
Falcon Pinze Per Torquing Con Chiave	165	Grifman Strumenti Per Modellare	139	Ladmore Abbassalingua	120
Falcon Pinze Per Uncini	53	Gross-Maier Pinze Porta Tamponi	112	Ladmore Brunitori	34,39
Falcon Pinzette Per Carta Da Articolazioni	50	Guanti Aloecare	198	Lame Per Bisturi	105
Falcon Pinzette Per Posizionare Tubi Buccali	145	Guanti SoftFlex in Nitrile	199	Lame Per Seghetto	135
Falcon Porta Matrici	51			Lampade Ad Alcool	132
Falcon Scollatori Per Rialzo Del Seno	94	H		Langenbeck Divaricatori	119
Falcon Spatole Per Alginato	136,137	Halsey Porta Aghi	115	Lecluse Leve Per Radici	72
Falcon Spatole Per Gesso	136	Halsted Mosquito Pinze Emostatiche	113	Lecron Strumenti Per Modellare	139,140
Falcon Spessimetri Per Osso	87	Hartman Pinze Emostatiche	113	Lecron-Mini Strumenti Per Modellare	140
Falcon Spessimetri Per Osso	87	Hedstrom Lime	26	Lessman Coltelli Per Cera	137
Falcon Spreaders Canalari	30	Heidebrink Leve Per Radici	66	Levataro (Scaler)	21-24
Falcon Strumenti Per Modellare	139,140	Heidemann Strumenti Per Otturazioni	35,41,42,43	Leve Per Frammenti	66,71
Falcon Strumenti Per Otturazioni	35,41,42,43	Heister Apribocca	104	Leve Per Radici	65-72
Falcon-Cut Forbici	106	Hemingway Cucchiari Alveolari	98,99	Lichtenstein Spatole Per Gesso	136
Falcon-Cut Pinze	153,154,161,162,166	Hilger Divaricatori Per Guance	103	Lime Per Canali	26
Falcon-Cut Tronchesino Per Filo	153,154,161,162,166	Hirschfield Scollaperiostei	96	Lime Per Osso	100
Falcon-Grip Pinze	157,158,167	Hollenback Carvers	47	Lindo-Levian Leve Per Radici	70
Falcon-Grip Pinzette Anatomiche	110	Hollenback Otturatori Per Amalgama	34	Lister Forbici per Fasce	109
Falcon-Grip Pinzette Chirurgiche	110	Hollow Chop Pinze Per Formare Archi	164	Littauer Forbici per legature	109
Falcon-Grip Porta Aghi	114-115	Hopkins Scollaperiostei	96	Locklin Forbici	107
Falcon-Grip Porta Aghi Micro	86	How Pinze Universali	157,163	London Hospital Leve Per Radici	71
Falcon-ject Ultima Siringhe Intraligamentali	56	Howard Lime Per Osso	100	Lucas Cucchiari Alveolari	98,99
Falcon-Polska Brunitori	40	Hygenist Levataro	21-24	Luce per esame a LED	9
Falcon-Polska Escavatori	46	Hyllin Ceramica Strumenti Per Modellare	140	Luer Pinze Ossivore Alveolotome	102
Falcon-Polska Levataro	24	Hyllin Leve Per Radici	70	Luxators	
Falcon-Polska Otturatori Per Amalgama	38	Hyllin Strumenti Per Modellare	139,140		
Farabeuf Divaricatori	118	Hyllin-Falcon Strumenti Per Modellare	140	M	
Feather-Lite Siringhe	59	Hyllin-Lecron Strumenti Per Modellare	140	Magnum Pinze Universali	65,67
Ferrier Finitore Per Bordi Gengivali	46			Mall Otturatori Per Amalgama	172
Finitore Per Bordi Gengivali	46	I		Manici per bisturi	37
Flagg Pinzette Per Medicazione	12	ID-Color Bottoni in Silicone	130	Manici Per Micro Specchietti	105
Flohr Leve Per Radici	66,70	ID-Color Porta Impronte	125	Manici Per Micro lame	9,85
Forbici	106-109	Impronta-Accessori	121-130,200-201	Manici Per Sinesmolomo	9,85
Forbici Micro	86	Incudine	134	Manici Per Specchi Foto Intraorali	73
Forbici Per Corone	134	Iniettori per Osso	89	Manici Per Specchietti Per Bocca	11
Forbici per Fasce	109	Iris Forbici	106-108	Manico Per Fogli In Acetato	8
Forbici per legature	109	Iris Pinzette Anatomiche	110	Markley Otturatori Per Amalgama	196
Forester Pinza Porta Spugna	112	Iris Pinzette Chirurgiche	110	Martelletti Per Rivettare	37,38
Fox Piano di Occlusione	123	IV Pinze Per Forare La Diga	53	Martelli Chirurgici	134
Frahm Carvers	47	IV Pinze Per Uncini	53	Maryland Moffit Sonda Millimetriche	88,101
Frazier Cannula Per Aspirazione	120	Ivory Matrici	51	Mathieu Porta Aghi	6
Freedman Brunitori	40	Ivory Porta Matrici	51	Mathieu-Kocher Porta Aghi	115,117
Freer Scollaperiostei	96	Iwanson Calibri	134	Matrici	115,117
Fresoni In Tungsteno HP	141,142			Mayo Forbici	51
Friedman Leve Per Radici	70	J		Mayo-Hegar Porta Aghi	109
Friedmann Pinze Ossivore Alveolotome	102	Jacquette Levataro	21-24	McFarlane Curette sopra-gengivali a "zappa"	115,116
Friedmann-Micro Pinze Ossivore Alveolotome	102	Jacquette-Towner Levataro	22,23	McFarlane Levataro	20
Friedmann-Mini Pinze Ossivore Alveolotome	102	Jarabak Pinze Per Piegare	157,164	Mckellops Pinze Di Per Anse Chiuse	21
Furrer Pinze Per Corone	50	Johnson Pinza Per Contornare Le Bande	151	Mead Martelli Chirurgici	170
		Jones Pinze Per Pannolino	112	Mead Pinze Ossivore Alveolotome	101
G				Mead/West Scollaperiostei	102
G. Lorenzetti Trituratore per osso	89	K		Meissner Pinze Per Estrazione	96
Gardner Scalpelli Per Osso	101	Kappen In Vetro	195	Meriam Pinzette Per Medicazione	82
Gerald Pinzette Anatomiche	110	Keal Pinzette Per Posizionare Tubi Buccali	145	Merrit Sonda Millimetriche	12
Gerald Pinzette Chirurgiche	110	Kelly Forbici	106-108	Mershon Spingibanda	6
Gillies Porta Aghi	117	Kelly Pinze Emostatiche	113	Metzenbaum Forbici	145
Gillies Uncini Cutanei	120	Kelly-Rankin Pinze Emostatiche	113	Metzenbaum-Delicate Forbici	106,108
Goldman-Fox Cesole Per Osso	101	Kilner Divaricatori Per Guance	103	Michigan Sonda Millimetriche	109
Goldman-Fox Curette sopra-gengivali a "zappa"	20	Kilner Uncini Cutanei	120	Micro Applicatori Per Endodonzia	5,6
Goldman-Fox Forbici	106-108	Kirkland Bisturi Per Gengivectomia	97	Micro Bruciatori	31



	Pagina
Micro Forbici	132
Micro Lame per Bisturi	86
Micro Otturatori/Brunitori Per Endodonzia	85
Micro Pinze Per Endodonzia	30
Micro Pinzette Anatomiche	32
Micro Pinzette Chirurgiche	85
Micro Pinzette Watchmaker	85
Micro Porta Aghi	111
Micro Specchietti Per Bocca	85,86
Micro Strumenti	8
Micro Strumenti	85,86
Microapplicatori Monouso	202
Middeldorp Divaricatori	119
Miller Lime Per Osso	100
Miller Pinzette Per Carta Da Articolazioni	50
Minnesota Divaricatori Per Guance	103
Misuratore Per Canali	192
Modello Inglese Spingi Amalgama	36
Modello Svizzero Spingi Amalgama	36
Modello Tedesco Spingi Amalgama	36
Molt Apribocca	104
Molt Cucchiari Alveolari	100
Molt Curettes Per Endodonzia	32
Molt Scollaperiostei	96
Morsetta Per Matrici	51
Mortaio E Pestello	195
Mortaio Per Amalgama	36
Mortaio Per Osso	89
Mosquito Pinze Emostatiche	113
Mosquito-Micro Pinze Emostatiche	113
N	
Nabers Sonde Millimetriche	5
Nance Pinze Per Anse Chiuse	157,165
Nance Pinze Per Formare Ganci Di Adams	170
Negativoscopi	14
Niti-Strumenti Canalari	26
Normografo Cefalometrico	144
Normografo Correlometer	144
Normografo Rickets	144
Normografo Tracing	144
Noyes/Castroviejo Forbici	108
Nyström Matrici	51
Nyström Porta Matrice	51
O	
Obwegeser Divaricatore Per Spina-Nasale	104
Obwegeser Divaricatore Ramus	104
Occhiali Protettivi	195
Occlusore	132
Ochsenbein Scalpelli Per Osso	101
Ohi Scollaperiostei	97
Olsen-Hegar Porta Aghi	115,116
Omega Pinze Per Anse Chiuse	158
Orban Bisturi Per Gengivectomia	97
Organizers	175-176
Oringer Divaricatori Per Labbra e Guance	103
Orthobox	174
Ortodonzia-Strumenti	143-176
Osteotomi	101
Osteotomi Per Condensazione	91
Osteotomi Per Implantologia	88
Osteotomi Per Rialzo Del Seno	92
Otturatori Per Amalgama	34,37,38
Otturatori Per Canali	27,29
Otturatori/Brunitori Per Micro Endodonzia	30

	Pagina
P	
P.K. Thomas Strumenti Per Modellare	138,139
Parker-Langenbeck Divaricatori	118
Parodontologia-Strumenti	15-24
Parlisch Martelli Chirurgici	101
Parlisch Scalpelli Per Osso	101
Parlisch Sgorbie Per Osso	101
Pean Pinze Emostatiche	113
Peeso Pinze Per Contornare	168
Peeso Pinze Per Piegare	168
Peel Pinze Per Frammenti	32
Perfection Specchietti Per Bocca	8
Periotomi	95
Perry Pinzette Per Medicazione	12
Piastra In Vetro Per Miscelazione	44
Piatto Per Forare La Diga	53
Pichard Scollaperiostei	96
Pichard Scollaperiostei Per Implantologia	95
Pietre Per Affilare	196
Pinze Da Laboratorio	166-172
Pinze Emostatiche	113
Pinze Ossivore Alveolotome	101,102
Pinze Per Anse Chiuse	157,165,169,170,172
Pinze Per Cilindri E Muffole	135
Pinze Per Contornare	151,168
Pinze Per Contornare Archi	155
Pinze Per Corone	50,134
Pinze Per Endodonzia	32
Pinze Per Estrazione	74-82
Pinze Per Estrazione Con Manico Anatomico	76-80
Pinze Per Estrazione In Titanio	81
Pinze Per Estrazione Modello Europeo	76-80
Pinze Per Estrazione Per Bambini	75
Pinze Per Forare La Diga	53
Pinze Per Formare Archi	156,164,165
Pinze Per Formare Archi Linguali	155,165
Pinze Per Formare Ganci Di Adams	170
Pinze Per Formare Le Legature	164
Pinze Per Frammenti	32,111
Pinze Per Griappare Ganci Chirurgici E Stop	156,165
Pinze Per La Rimozione Di Attacchi	152,160,162
Pinze Per La Rimozione Di Corpi	151,160,162
Pinze Per La Rimozione Di Corpi	32
Pinze per lame bisturi	105
Pinze Per Legature	150
Pinze Per Matrici	51
Pinze Per Ortodonzia	147-165
Pinze Per Pannolino	112
Pinze Per Piegare	155-172
Pinze Per Piegare Ganci A Freccia	170
Pinze Per Piegare I Distali (Cinch Back)	156,164
Pinze Per Piegatura a Baionetta	165
Pinze Per Piegatura a V	165
Pinze Per Posizionare Le Bande	151
Pinze Per Rialzo Del Seno	87
Pinze Per Rimuovere Residui Di Adesivo	162
Pinze Per Sterilizzazione	190
Pinze Per Tendere Elastici	149
Pinze Per Togliere I Tappi Dei Tubetti Buccali Convertibili	152
Pinze Per Torquing Con Chiave	165
Pinze Per Uncini	53
Pinze Porta Spugna	112
Pinze Porta Tamponi	112
Pinze Riposizionatrici Di Osso	89
Pinze Universali	171,172
Pinze Utilità/Universali	157,158,160,163
Pinzette Anatomiche	110,111
Pinzette Anatomiche Micro	85
Pinzette Atraumatiche	110

	Pagina
Pinzette Chirurgiche	110,111
Pinzette Chirurgiche Micro	85
Pinzette Per Carta Da Articolazioni	50
Pinzette Per Endodonzia	32
Pinzette Per Estrazione	82
Pinzette Per Marcare Le Tasche	97
Pinzette Per Medicazione	12
Pinzette Per Posizionamento Della Membrana	90
Pinzette Per Posizionare Attacchi	146
Pinzette Per Posizionare Tubi Buccali	145
Pinzette Per Radiografie	196
Pinzette Per Rimuovere Le Legature	149
Pinzette Per Saldatura	135
Pinzette Per Sutura	120
Pinzette Per Trattenere Le Frese	191
Pistol-Ject Siringhe Intraligamentali	56,60
P-Ject Siringhe Ad Aspirazione Manuale	60
Pluggers Per Canali	27,29
Porta Aghi	114-117
Porta Aghi Micro	85,86
Porta Impronte In Acciaio Inox	125-129
Porta Impronte In Alluminio	125-129
Porta Impronte Monouso	124
Porta Matrici	51
Potts Leve Per Radici	72
Prodotti Monouso	197-202
Projection-System Siringhe Autoaspiranti	57,59
Proteggi-Dito	104
Protezione In Plastica	56
Pulitore Per Strumenti Canalari	192
Puntali Miscelatori	200-201
Punte Parodontale Ad Ultrasuoni	16
Punte Per Ablatori Ad Ultrasuoni	16
Punte Per Chirurgia	84
Punte Per Endodonzia Ad Ultrasuoni	27
Punte Per Prep. Cavità	36
Q	
Quatro Siringhe Ad Aspirazione Auto/Manuale	57
R	
Raccogliore Per Osso	90
Rastrelliera Per Vassoi	187-189
Real Series Modelli Dentali	177-182
Reamers Per Canalari	27
Reynolds Pinza Per Contornare Le Bande	151
Righelli	144
Rivestimento Per Pinze	175
Roach Strumenti Per Modellare	139
Rochester-Pean Pinze Emostatiche	113
Roghe Spatole Per Gesso	136
Roser-König Apribocca	104
Routurier Pinze Per Estrazione	82
Ruddle Curettes Per Endodonzia	32
S	
Sacks Coltelli Per Gesso	136
Scalpellini Per Osso	101
Scalpellini Per Parodontologia	20
Schaedel Pinze Per Pannolino	112
Schlemmer Leve Per Radici	71
Schmeckebler Leve Per Radici	68
Schwarz Pinze Per Anse Chiuse	169
Schwarz Pinze Per Piegare Ganci A Freccia	170
Scollaperiostei	96,97
Scollaperiostei Per Implantologia	95
Scollatori Per Rialzo Del Seno	94
Seghetti Per Laboratorio	135

	Pagina		Pagina		Pagina
Seghetti Per Gesso	135	Strabismus Forbici	106	Vassoio Endodontico	192
Seldin Leve Per Radici	68	Strisce Monoabrasive	145	Vassoio Porta Uncini	53
Seldin Scollaperiostei	97	Strumenti Per Diga	52-54	Vehe Strumenti Per Modellare	139
Semken Pinzette Anatomiche	110	Strumenti Da Smalto	46	W	
Semken Pinzette Chirurgiche	110	Strumenti Levacorone	49,50	Wakefield Osteotomi	101
Senn-Miller Divaricatori	118	Strumenti Per Ceramica	138	Waldsachs Pinze Universale	171
Serie Ottone Siringhe	60,61	Strumenti Per Corone	49,50,134	Walter F. Barry Leve Per Radici	72
Serie Piuma Siringhe	59	Strumenti per cure canalari	31	Wards Otturatori Per Amalgama	37
Set Di Strumenti Per Diga	54	Strumenti Per Filo Retrattore	123	Wards Strumenti Per Modellare	47
Set Di Strumenti Per Estrazione	64	Strumenti Per Implantologia	87	Warwick-James Leve Per Radici	66,71
Set Riparo Di Sicurezza	145	Strumenti Per Impronta Di Silicone	123	Weingart Pinze Universali	158,160,163
Set Strumenti Prima Visita	13	Strumenti Per Modellare	139,140	Weitlaner Divaricatori Autostatici	120
Sgorbie Per Osso	101	Strumenti Per Otturazioni	34-44	Wescott Brunitori	34,39,40
Simplex Divaricatori Per Guance	103	Strumenti Per Posizionamento Della Membrana	90	Weston Spatoline Per Cemento	44
Sindesmotomi	73	Strumenti Per Rifinire	47,48	White Brunitori	34,40
Siringhe Ad Aspirazione Manuale	57-61	Strumenti Per Rimuovere Otturazioni	48	WHO Sonde Millimetriche	5,6
Siringhe Autoaspiranti	57,59,60	Strumento 'A Freddo' In Niti	148	Wieder Abbassalingua	104
Siringhe Intraligamentali	56,60	Strumento Per l'Applicazione Medicamenti	43	Wiland Strumenti per Modellare	47
Siringhe Monouso Per Impronte	201	Strumento Per Piegare I Distali	148,156,164	Williams Sonde Millimetriche	5,6
Siringhe Per Anestesia	55-62	Strumento Per Rimuovere Elastici	147	Williger Cucchiari Alveolari	100
Smaha Pinze Per Legature	150	Strumento Per Rimuovere L'Adesivo	146	Williger Scollaperiostei	97
SoftFlex Guanti In Nitrile	199	Strumento Porta Strisce Abrasive Interdentali	145	Winter Leve Per Radici	72
Soft-Grip Pinze	160	Super-Cut Forbici	107	Witzel Pinze Per Estrazione	82
SOFT-LINE Cucchiari Alveolari	98	Supporto Per Pinze	175-176	Woodson Strumenti Per Otturazioni	41
SOFT-LINE Manici Per Specchietti	9	Svedese Siringhe Intraligamentali	56,60	Wynman Pinze Per Corone	50
SOFT-LINE Sonde	2,4	Swedish Micro Vascular Porta Aghi	115	Y	
SOFT-LINE Sonde Millimetriche	6	T		Young Pinze Per Anse Chiuse	170
SOFT-LINE Strumenti Per Endodonzia	28-32	Tanner Otturatori Per Amalgama	34	Young Telai Per Diga	53
SOFT-LINE Strumenti Per Impronta	123	Tanner Strumenti per rifinire	48	Younger-Good Levatartaro	22,23
SOFT-LINE Strumenti Per Laboratorio	139	Taylor Levatartaro	21-23	Z	
SOFT-LINE Strumenti Per Ortodonzia	145-148	Tazze In Acciaio Inox	190	Zahle Strumenti Per Modellare	139,149
SOFT-LINE Strumenti Per Otturazioni 38,40,43,44,45,47	145-148	Tazze In Acciaio Inox	190		
SOFT-LINE Strumenti Per Parodontologia	18,21	Tazze Per Alginato	135		
Sonde	120	Tazze Per Gesso	135		
Sonde	2-4	Telai Per Diga	53		
Sonde Millimetriche	5,6	Terminali Intraorali Monouso	201		
Sonde Per Canali	28	TG Scalpelli Per Parodontologia	20		
Sonde Per Implantologia	87	Toennis Porta Aghi	115		
Spatole Per Alginato	136,137	Tofflemire Matrici	51		
Spatole Per Gesso	136	Tofflemire Porta Matrici	51		
Spatoline Monouso	202	Tomati Pinze Ossivore Alveolotome	102		
Spatoline Per Cemento	44	Torretta Per Formare Archi	148		
Specchi Per Foto Interorali	10,11	Towner Levatartaro	24		
Specchietti Per Bocca	7,8	Trio Siringhe Ad Aspirazione Auto/Manuale	57		
Specchietti Per Bocca A Riflessione Frontale	8	Trituratore Per Osso	89		
Specchietti Per Bocca Concavi	8	Tronchesini Distali	153,160,161		
Specchietti Per Bocca Cromati	8	Tronchesino Per Filo	153,154,161,162,166		
Specchietti Per Bocca Illuminati	7	Tronchesino Per Legature	154,160,161		
Specchietti Per Bocca Micro	8	True-Flex Uncini Per Diga	52		
Specchietti Per Bocca Mod. Perfection	8	Tweed Pinze Di Per Anse Chiuse	158,163,164		
Specchietti Per Bocca Piani	8	Tweed/Angel Pinze Per Formare Archi	156,165		
Specchietti Per Bocca Rodiati	8	U			
Spencer Forbici per legature	109	Ultima Base Riponi Ago	62		
Spessimetri Per Osso	87	UNC Sonde Millimetriche	6		
Spingi Amalgama	36	Uncini Cutanei	120		
Spingi Amalgama Per Micro Otturazioni	36	Uncini Per Diga	52		
Spingibanda	145	UniPress Dispenser per elastomeri universale	122		
Spreaders Per Canali	27,30	Universal Forbici per Fasce	109		
SS-2000 Siringhe	56-58	University of Minnesota Divaricatori Per Guance	103		
Standard Forbici	109	USA Mod. Porta Impronte	125-127		
Standard Levatartaro	24	USC Strumenti per rifinire	47		
Steiner Pinze Per Legature	150	V			
Sterilizzazione E Varie	183-196	Vassoi in Plastica Monouso	202		
Sternberg Divaricatori Per Guance	103	Vassoi Porta Strumenti	187-189		
Stieglitz Pinze Per Frammenti	111	Vassoi Reniformi	190		
Stokes Pinze Per Uncini	53				
Stokes/Palmer Pinze Per Uncini	53				
Stoppini Di Ricambio Per Lampade Ad Alcool	132				



Falcon Medical Italia Srl.

Office address / Sede operativa:

Via D. Chelini, 132/b

55100 Lucca - Italy

Tel: +39 0583 490459

Fax: +39 0583 463628

www.falconmedical.it

info@falconmedical.it

Legal address / Sede legale:

Via dei Bichi, 340

55100 S. Marco, Lucca - Italy

Warehouse / Magazzini:

Viale Castracani, 261/A

55100 Lucca - Italy