

Always one step ahead!



Nr.18

Dentistry Catalog | *Dental Products Worldwide*



**HÄGER
WERKEN**

Dentalprodukte weltweit
Dental Products Worldwide

Our team worldwide



See our Xylitol range on pages 56 + 57.



Patrick Hager,
General Manager

Michael Hager,
Senior Adviser



IDS 2013



Hager Worldwide, Inc.
441 19th Street SE
Hickory N.C. 28602, USA
Tel.: +001 (828) 624-3300
Fax: +001 (828) 624-3303
E-Mail: contact@hagerworldwide.com
Website: www.hagerworldwide.com
General Manager: Mark Schneider



Hager Polonia Sp. z o.o.
Ul. Galczyńskiego 23
52-214 Wrocław
Telefon: +48 - 71-368-71-66
Fax: +48 - 71-368-10-21
E-Mail: biuro@hager.com.pl
General Manager: Ania Biernacka-Świenc



"HAGER EURASIA" OOO
127051, Moscow, Russia
Tsvetnoy bulvard, 30, Bldg. 1
Telefon / Fax: +7 495 255 0902
E-Mail: o.seifert@hagerwerken.de
General Manager: Olga Seifert



HAGER PHARMA GmbH
Ackerstraße 1, 47269 Duisburg
Telefon +49 (203) 99 269 900, Fax +49 (203) 99 269 999
info@hager-pharma.de, www.hager-pharma.de
General Manager: Klemens Böhm



Mob(HK): +852-9168 0419
Mob: +86-138 1780 6110
Tel(HK): +852-2622 2796
Tel: +86-21-6210 3519
E-Mail: kate@hagerasia.com.hk
General Manager: Kate Tsui

Shanghai Office
RM.1108 Zhaofeng Garden Building
No. 969 Channing Road
200050 Shanghai China
Tel: +86-21-5239 8136
Fax: +86-21-5239 8135
E-Mail: info@hagerasia.com

Hong Kong Office
Unit 5 & 10, 9/F,
139-141 Hoi Bun Road, Seaview Centre
Kowloon, Hong Kong
Tel: +852-2622 2795
Fax: +852-2622 2503
E-Mail: info@hagerasia.com.hk



Hager & Werken GmbH & Co. KG
Ackerstraße 1, 47269 Duisburg,
Germany
Telefon +49 (203) 99269-0
Fax +49 (203) 299283
E-Mail info@hagerwerken.de
Internet www.hagerwerken.de
General Manager: Patrick Hager

Hager & Werken – The Catalog

This 18th edition of our English catalog offers a variety of new, innovative products. Over the years, the Hager & Werken catalog has become a compendium for interesting dental specialties, consumables and innovative small equipment. We dedicate ourselves to provide the dental community with the highest level of quality products and services.

One of the most important new products is LaserHF „comfort“ – a combination of Laser- and Radiosurgery in one device, offering the advantages of both worlds. This unique combination is not only space-saving and effective, but also very attractive price wise.

With ImplantMarker Hager & Werken offers a unique preventive care system for dental implants. Within minutes hidden inflammations can be diagnosed reliably in a very early stage long before conventional methods would show anything. The dentist can start his treatment and take counter measurements right away.

A strict quality control system is the basis for our sustained success and growth. Hager & Werken has established a rigid quality management system according to ISO 9001 and ISO 13485 (certified by TÜV Rheinland, Cologne – Germany). This assures that our products are manufactured and distributed under highest possible standards.

Patrick Hager

Our team – always at your service!

For questions and orders please contact our sales representatives, our sales team in Duisburg or your dental dealer. Detailed and up-to-date information about our products can be found on the Internet at:

www.hagerwerken.de and www.miradent.de

Our team in Duisburg is available

**Monday to Thursday 08.00 – 17.00
and Friday 08.00 – 16.00**

Fon: +49 (203) 99 269 + extension number

Fax: +49(203) 29 92 83

Service Export

Susanne Bah, s.bah@hagerwerken.de

- 45

Anneli Heyse, a.heyse@hagerwerken.de

- 43

Lidia Benedetti, l.benedetti@hagerwerken.de

- 42

Julia Heckmann, j.heckmann@hagerwerken.de

- 47

Technical Service

Kuno Kunert, k.kunert@hagerwerken.de

European Sales and Marketing Director

Marcus van Dijk, m.vandijk@hagerwerken.de

- 16

European Sales Manager

Jörg Zensen, j.zensen@hagerwerken.de

+49 (172) 210 72 03

Sales Manager Austria/Switzerland

Simone Krug, s.krug@hagerwerken.de

+43 (664) 150 1417

Sales Manager France/Spain/Portugal

Séverine Sánchez, s.sanchez@hagerwerken.de

+34 (687) 381 020

Sales Manager Adriatic Region

Klaudija Mateljak, Klaudija@hagerwerken.de

+385 (98) 997 4678

Marketing Export

Samy Mamlouk, s.mamlouk@hagerwerken.de

- 17

Junior Sales Manager

Pedro Nkanu, p.nkanu@hagerwerken.de

- 41

Always at your service



German headquarters



Hager Worldwide Corporate Office Hickory, North Carolina



Hager Polonia Corporate Office Wroclaw (Breslau), Poland

Subject to changes and variations. Our terms of supply and our payment terms apply exclusively.



31 GapSeal® - Periimplantitis Prophylaxis

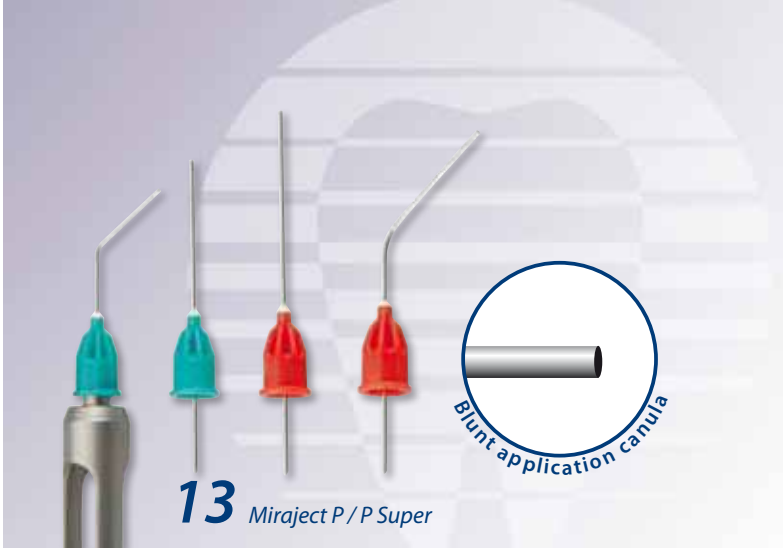

13 Miraject P / P Super



16 Miramatic No-Touch-System

CONTENT



Plantana

Plantana Lip Balm **55**

08 Impression

The new impression tray with patented foil technique is a development of the team of Prof. Dr. Spiekermann (University of Aachen). Implant posts penetrate the foil quick, clean and with high-precision. Big time and cost savings as no laboratory or 2nd patient impression is needed.

12 Application/Injection

Since 1967 Miraject has been standing for leadership and quality. Over 500 million blunt and bendable application canulas with ensured precise and controllable application of liquids and pastes.

18 Fit® Rubberdam

Excellent quality and long-lasting constant clamp force. Our stainless steel "formula" grant high precision and adjust individually to the corresponding tooth. We offer all clamps optional in non-reflecting dull black, e.g. ideal for microscopes and loopes usage

24 Fillings/Endodontics

Many little helpers saving time while the dentist while offering additional patient comfort, e.g. our fissure printer for composite fillings, our atraumatic Crown-Click or N2 root canal cement for difficult cases.



halitosis spray **66**

Chewing against caries



Xylitol **57**



Prosonic micro 2 **59**



Miradent No. 15 – Mini Ponies **54**



Proto Cam® **91**

31 Dental Supplies

Wide range of innovative products such as Reso-Pac, a "self-dissolving 'plaster' in the mouth," GapSeal THE prevention against Periimplantitis, Mirahold bite blocks to hold mouths open and much more ...

50 Patient Service and Motivation

Our study models educate patients and create awareness for high quality prosthetic restorations. Additionally we feature a wide range of toys to reward brave, young patients.

56 miradent®

Our prophylaxis home care assortment: a full range from infant to senior care products. In our campaign "Chew against Plaque" we educate about the benefits of Xylitol e.g. anti-cariogenic effects.

70 Devices

For over 30 years we have been a reliable partner for modern radio-frequency surgery units. Our LaserHF offers the perfect combination of Laser and RF technology.

75 Laboratory and Dental Supplies

For (in-office) labs, we offer small devices and consumables. Highly appreciated best sellers are : Occlu Spray, Mirawet mixing liquid, our light curing Speed Labolight and our portable Micromotor Bravo Portable.

88 Protection and Hygiene

As a market leader for dental eye protection, we not only emphasize on safety but also on comfort and stylish looks. In addition to our iSpec series we offer face shields and a low priced H&W protective eyewear.

Index Key Words

Absorber Box	86	Demo Model	51	Laser	70	Relaxion Aid	55
Adhesive Spray		Dental Burner	84–85	Laser-Bleaching	73	Removal of Crowns/Bridges	26
for Impression Trays	9	Dental Care Chewing Gum	57	Laser Safety Glasses	92	Replacement Brushes	
Adhesive Wound		Dental Care Model	50	Laser Accessories	73	Interdental Cleaning	64
Protection Paste	33	Dental Care Travel Kit	58	Learner's toothbrush	68	Rescue Box in Tooth Accidents	56
Air Polishing	86	Denture Box	67	Light Polymerisation Device	80	Rhodium-Coated Front Mirror	36
Alginate Mixing Device	82	Denture Brush	67	Lip-Balm	55	Rinsing Needles	14
Alginate Remover	10	Denture Cleaning Device	85	Lip Retractor/Holder	35	Root Build-Up Posts	28–29
Aluminium Oxide Powder	86	Disinfection	40	Luer Needles	13–14	Root Canal Cement	30
Amalgam Well	27	Disinfection Wipes	40			Root Canal Rinsing	14
Amine Fluoride Toothpaste	61	Disposable Aspiration Canulas	45	Marking Instrument	27	Root Planing	30
Application Aids	11	Disposable Impression Tray	8–9	Marking of X-Ray Films	38	Rubber Cups	47
Application Brush	11	Disposable Mask	40	Matrix Retainer	25	Rubberdam Clamps	20–23
Application Canula	13–14	Disposable Mouth Mirror	36	Membrane Container	79	Rubberdam Cuts	19
Application Tip	11	Disposable Toothbrush	58–59	Metal Mouth Mirror	36	Rubberdam	18–23
Application Tray		Disposable Treatment Set	34	Micro Motors	81		
for Fluoride Gel	48			Micro Nutrient Gel	48	Safety System Injection	16
Aspiration Box	86	Early Diagnosis	49	Micro Spiral Brush	47	Sandblasting Device	86
Aspiration Canulas	44–45	Electrodes for HF	72	Millimetre Scale		Silicone Cleaning Foam	40
		Electronic Vibration Table	82	for X-Ray Films	38	Splinting Nets	24
		Etching Gel	25	Mirror for Patients	36	Spray Disinfection	40
Baby Toothbrush	68	Eye Protection	88–93	Mixing Bowls	82	Stainless Steel Frame	
Bipolar-Forceps	72			Mouthmask	40	for Rubberdam	19
Bite Blocks	35	Face Protection Shield	91	Mouth Mirrors	36	Stainless Steel Impression Tray	10
Bite Cushion X-Ray	37	Fibre Post System	47	Mouth Opening	35	Storage Boxes	50/68
Bite Cushion	26	Film Holders / Pockets	37	Mouth Rinsing Solution		Storage of Milk Teeth	54
Bleaching Gel	73	Fit Rubberdam Clamps	20–23	with CHX	60	Study Model	51
Bleaching Gelee	61	Fissure Stamp	25	Mouth Rinsing Tablets	46	Surface Preparation	86
Bleaching Handpiece	73	Fit Rubberdam Latex	19	Multifunction Cart	74	Surgical Aspiration Cannula	43
Blunt Needles	13–14	Fit Rubberdam	18–23			Syringe Stand	17
Bridge Remover	26	Floss Dispenser	62	Napkin Holders	41	Syringes	17
Brushes for Application	11	Floss Fibres with CHX	62	Needle Box	16		
Budy Care	55	Floss	62	Needles	12–16		
Build-Up Posts	28–29	Fluoride Gel	48			Tape Dental Floss	62
Burner	84–85	Fluoride Varnish	48	Occlusion Spray	27	Teaching Toothbrush	68
		Foldable Plastic Frame	19	Over-the-Glass		Template for Rubberdam	18
Calcium Hydroxide Paste	25	Forceps for Rubberdam	18	Protective Eyewear	90, 91, 93	Timekeeper	68
Canula for Endodontics	13	Frame for Rubberdam	19			Tips and Connecting Pieces	
Canulas	12–16	Fresh Breath	66	Parallel Drilling Aid		for Aspiration Canulas	44
Caps for Core Build-Up	27	Fully Synthetic		for Implants	32	Tissue Adhesive	32
Carts	74	Maintenance Product	85	Partial Impression	9	Tongue Cleaner	67
Cervical Clamps				Paste Needles	13–14	Tongue Gel	67
for Rubberdam	20	Gas for Burner	84	Patient Mirror	36/50	Tooth Coin Bank	55
Cheek and Lip Retractor	35	Glass Fibre Band	24	Patient Service	50–55	Tooth Picks	63
Cheek Holder	35	Glass Fibre Build-Up Post	28–29	Pen for Marking		Tooth Rinsing Solution	60
Chewing Gum	57	Glasses	88–93	of X-Ray Pictures	38	Tooth Whitening	60/73
Children's Toothbrushes	69	Grid Bows	24	Phosphoric Acid Gel	25	Toothbrush Holders	69
Chlorhexidine Dental Floss	62			Pipettes	41	Toothbrushes	58–59
Chlorhexidine		Hand Pieces		Plaque Test Tablets	66	Toothbrushes for Children	69
Interdental Brushes	63	and Contra-Angles	87	Plastic Aspiration Canulas	43–45	Toothpaste	61
Chlorhexidine		Hand Cleaning Brush	39	Plastic Caps for Core Build-Up	27	Toys	52–54
Mouth Rinsing Solution	60	Hand Mirror	36/50	Plastic Impression Tray	8–9	Transport and Storage Box	50/79
Chlorhexidine Paste	48	Hand Pieces	87	Pointed Brush	65	Tweezers	34/42
Clamp Forceps for Rubberdam	18	Hand Puppets with Dentition	52	Polymerisation Device	80		
Cleaning Brush	39	Heating Device	83	Post Build-Up	28–29	Ultrasonic Toothbrush	59
Cleaning Brush for Canulas	43	Holder for Dental Floss	62	Postoperative Treatment	33	Underlinings	25
Cleaning Foam	40	Holder for Interdental Brushes	64	Pouches for X-Ray Pictures	37	Universal HF Surgery Unit	70
Cleaning of Impression Trays	10	Hourglass	68	Powder for		User reports	94
Cleaning Solution	39			Sandblasting Devices	86	Uvex Glasses	89–91
Cold Compress	39	Implant Impression Tray		Practice Cleaning Foam	40		
Cold Spray	39	with Foil Technique	8	Prophy Tips	47	Vibrating Unit	82
Collector-free AC motor	81	Implant Sealing	11	Prophylaxis Hand Pieces			
Colouring Tablet		Implant Tray Cleaning	10	and Contra-Angles	87	Wound Dressing	33
for Dental Plaque	66	Impression Tray	8–10	Prophylaxis Paste	46		
Contact Point Gauge	27	Impressions	8–10	Protective Eyewear	88–93	X-Ray Film Viewer	38
Container for Dental Floss	62	Indicator Solution		Pulp Build-Up Post	28–29	X-Ray Holder	37
Container for Disinfection	41	for Dental Plaque	66	Punch for Rubberdam	18	X-Ray Shield	37
Container for Needle Disposal	16	Injection Canulas	12–16			Xylitol	56–57
Contra-Angles	87	Instrument Oil	19	Radiation Protection Shield	37		
Core Build-Up	27	Intensive Tooth Care	61	Radio Frequency Surgery	70–71		
Crown and Bridge Remover	26	Interdental Brush Holder	64	Rapid Tests	49		
Cups for Tooth Cleaning	46	Interdental Brushes	64	Reamer	29		
Curette	30			Refill Gas for Burners	84		

Airsonic Absorbo Box	86	Hager Outbacks	88	Mirahold-Block	35	Proto-Cam	91
Airsonic Adapters	86	halitosis spray	66	Miraimplant	32	Putzi-Buddys	52
Airsonic Alu-Oxyd	86	Happy Morning	59	Miraject	15	Putzi-Pets	52
Airsonic Mini Sandblaster	86	Happy Morning De Luxe	58	Miraject Endo Luer	13		
Algilock	10	Happy Morning Travel Kit	58	Miraject Endo Rinse	14	Reflect-Rhod	36
Algilock Cleaner Plus	10	Happy Morning Xylitol	59	Miraject Endotec Duo	14	Reso-Pac	33
Algilock Perforated	10	hf1 Surg bipolar	71	Miraject Endotec Luer	14	Röntgomarker	38
Algiloid	83	hf Surg	71	Miraject Luer	15	Rotoprox	47
Algimix	82	hf Bipolar Forceps	72	Miraject PL Super	13		
Alminax	76	hf Elektrodes	72	Miraject P / P Super	13	Salibag	37
Alminax Rite-Bite	76	hf Neutral Elektrode	72	Miralay	42	Skalpell-Ex / Pin-Clipper	42
Amalgam Well	27	H&W Classic	92	Miramask	40	Spandex	35
Anti Stress Tooth	55	H&W Featherlight	92	Miramatic	16	Spandex-Vertical	35
Apply Tips	11	H&W Logic	93	Miramatic Aspi	17	Spandex-Vertical Eco	35
APT Gas	84	H&W OTG II	93	Miramatic-Box	16	Speed Labolight	80
APT III Burner	84	H&W Panorama	92	Miramatic Holder Plus	17	Speedo-Clean	85
Astro Clean	40, 93	H&W Panorama II	93	Miramatic Syringes	17	Steri-Suc-Tube	43
		H&W Sports Pro	93	Mirapont	78	Study Models	51
				Mirapont Agent Plus	78	Study Model	
Balance Articulator	80	ImplantMarker	49	Mirapor	75	Demo Implant C+B	51
BD-Steribox	41	Infant-O-Brush	68	Mira-Post	29	Super-Splint	24
Blue Flame 1500	84	Integra Cart De Luxe / De Luxe II	74	mirasensitive hap+	61	Super-Splint De Luxe	24
Bravo Marathon Portable III	81	Integra Fit-On Tray	74	Mirasuc 16	44		
Bravo TD III	81	I-Prox Care Set	65	Mirasuc Absorbo	45	Tong-Clin De Luxe	67
Brilliant	36	I-Prox chx	63	Mirasuc Adapter	44	Tong-Clin Fresh	67
Brilliant Anti-Fog	36	I-Prox P	65	Mirasuc Brush	43	Tong-Clin Gel	67
				Mirasucto	45	Toothbrushing Model	50
Calci-Line	25	Kid's Brush	69	Mirasuc-View	44	Tooth Coin Bank	55
Carat Biopaque	79	Kisag Burner	84	Miratoi Toys	52 – 54	Tweezer PL	34
Carat Isolation Fluid	79			Mirator 2000	82	Twin-Pipette	41
Carebrush supersoft	58	LaserHF Bleaching Hand Piece	73	Miratorch II	85		
Carebrush white	58	LaserHF „comfort“	70	Miratray	8	uvex Astro Lite	89
CC-Schild	91	LaserHF Curver	73	Miratray 140°	9	uvex Astrospec	89
Cervical Clamp 214	20	LaserHF Faser Cutter	73	Miratray Implant	8	uvex Astrospec 2.0	90
C-EX / B-EX	26	LaserHF Fibre-Tips	73	Miratray Mini	9	uvex I-VO / I-VO „S“	90
Chiru-Cleaner	43	LaserHF PDT Solution	72	Miratray Partial	9	uvex Pheos	89
Chirurgo-Suc I	43	laservision blue	92	Miratray Spray	9	uvex Racer	91
Chiru-Tip	43	laservision green	92	Mirawet	75	uvex Super Fit CR	90
Cold-Bag	39	laservision Lambda One	92	Mirawhite gelée	61	uvex Super-Fit UV	90
Contact Gauge	27	laservision Patient's Glasses	92	Mirawhite Laser Bleaching	73	uvex Super OTG	91
Corund SC	76	Liftbox	34	Mirawhite oxygen	60	uvex X-Trend	89
Cotton-Clip I + II	42			Myzotect-Tincture	33		
Cottoroll	42	Matrix-Retrainers	25			Variator-Kit	34
Crown Click De Luxe	26	McTooth Mirror	50	N2 Endodontic Cement	30	Vernax 100	77
		Membranbox	79	Non-Stick	76	Vernax Antagon	77
Del-Ject	27	Micro-Etch	25			Vernax Colloidal Graphite	77
Dento Box I + II	50, 68	Mira-2-Ton Solution	46, 66	Occlu-Print	25	Vernax G	77
Dentosmin P	33	Mira-2-Ton Tablets	66	Occlu Spray Plus	27, 76	Vernax S	77
Desmoclean	30	Mirabol	82	Orange-Solvent	39	Vernax Thinner	77
Dipol	75	Mirabrush	11	Orbatec	87		
		Mira Clean	46	Orbatec Holder	87	X-Ray Mesh	38
Emmenix Film Holder	37	Miraclean-Implant Black	32	Orbatec Prophyl	87	X-Ray Stain Remover	38
Emmenix Flap	37	Mira Cleaning Wipes	40			Xylitol Chewing Gum	57, 68
Exact Liner	27	Mira-Clin hap	46	Panascope	38	Xylitol Chewing Gum for Kids	57
		Mira-Clin-P	46	Parallelometer-Mirror	36	Xylitol Drops	57
Fit-N-Fix	41	Miraclip	41	paroguard	60	Xylitol Powder	56
Fit Rubberdam Clamp Board	18	Miracold Plus	39	Pelotte-Aspirator	45		
Fit Rubberdam Clamps	20 - 23	miradent Hourglass	68	Pelotte Plus	45	Zahnpick	63
Fit Rubberdam Clamps Black	20	miradent Mouth Mirror	65	Perfect Splint C	24		
Fit Rubberdam Clamps for Children	21	miradent SOS Dentobox	56	Perfect Splint-System	24		
Fit Rubberdam Eliot Separator	19	Miradont-Gel	48	PerioMarker	49		
Fit Rubberdam Folding Frame	19	Mira-Duo	50	Pic-Brush Intro Kit	64		
Fit Rubberdam Forceps	18	Mirafit 3 in 1	28	Pic-Brush Replacement Brushes	64		
Fit Rubberdam-Latex	19	Mirafit BC	27	Pic-Brush Set	64		
Fit Rubberdam		Mirafit Carbon and White	28	Pick up Stick	11		
Perforating Template	18	Mirafit Clear	29	Plantana	55		
Fit Rubberdam Starter Kit I	18	Mirafloss	62	Plantana Lip Balm	55		
Fit Rubberdam Starter Kit II	18	Mirafloss Big	62	Plaque Agent	69		
Fit Rubberdam Steel Frame	19	Mirafloss Implant chx	62	Praxipolish Plus	40		
Flexbrush	39	Mirafloss interspace	62	Praxipol PS	78		
Flex-O-Bol	82	Mirafluor C	61	Prophy-Angles	47		
Funny Animals	69	mirafuor chx	60	Prophy-Cup	47		
		mirafuor-gel	48	Prophy-Mandrell	47		
GapSeal	31	Mirafuorid	48	Prosonic micro 2	59		
Glas Bead Heater	83	mirafuor-k-gel (for children)	48	Protectoray	37		
Gripit	26	Mirafuor-Tray	48	Protho Box	67		
		Miraglu	32	Protho Brush De Luxe	67		
		Mirahold	35	Protho Clean	85		

Miratray® Implant



Implant impression tray with patented foil technique

- Saves you and your patient an additional patient visit and laboratory cost
- Controllable and safe impression taking with clear view of implant posts
- Clean impression is taken as foil meets precisely at implant posts
- No overflowing impression material
- Customisable, user-friendly and cost-effective
- Available in three sizes for maxilla and mandible (dentulous and edentulous)
- Suitable for all implant impression materials and implant systems

“Making an individual tray in laboratory is no longer necessary = time saving (appointment) and cost saving for the patient.”
Petra Weidenmüller, Magdeburg



Video

Article description	Size	Content	REF
Intro Kit 6 x 1 piece (Upper/Lower small, medium, large)			101 250
Upper, S1	small	6 pcs.	101 251
Upper, S2	medium	6 pcs.	101 252
Upper, S3	large	6 pcs.	101 253
Lower, I1	small	6 pcs.	101 254
Lower, I2	medium	6 pcs.	101 255
Lower, I3	large	6 pcs.	101 256

Miratray®

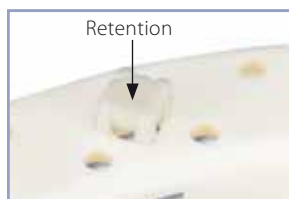

Disposable impression tray made of white plastic

- Inexpensive and solid, mouldable when heated
- Excellent retention of the impression material by special “retention baskets”
- Practical: can be labelled with felt-tip pen
- Complete tray available in six sizes

Article description	Size	Content	REF
Upper, S3	large	50 pcs.	101 142
Upper, S2	medium	50 pcs.	101 141
Upper, S1	small	50 pcs.	101 140
Lower, I3	large	50 pcs.	101 145
Lower, I2	medium	50 pcs.	101 144
Lower, I1	small	50 pcs.	101 143
Upper, S3	large	12 pcs.	101 172
Upper, S2	medium	12 pcs.	101 171
Upper, S1	small	12 pcs.	101 170
Lower, I3	large	12 pcs.	101 175
Lower, I2	medium	12 pcs.	101 174
Lower, I1	small	12 pcs.	101 173

S = Superior I = Inferior

Assortment I

50 complete/partial trays in nine designs, assorted:

Shape: I2 S2 S3 S1 I1 I3 PL PR PM
Quantity: 10 10 5 5 5 5 3 3 4

Article description	Content	REF
Assortment I, assorted	50 pcs.	101 149

For single impressions of crowns and small bridges

- Inexpensive disposable plastic tray
- Limited mouldability when slightly heated
- Can easily be slid onto corrugated tweezers
- Excellent for patients, avoids an urge to gag
- Saves impression materials

Article description	Content	REF
Miratray Mini	50 pcs.	101 102

Partial plastic impression tray in three shapes

- Excellent for patients feeling an urge to gag
- Saves impression material

Article description	Content	REF
Bag, PR right	12 pcs.	101 178
Box, PR right	100 pcs.	101 148
Bag, PL left	12 pcs.	101 176
Box, PL left	100 pcs.	101 146
Bag, PM middle	12 pcs.	101 177
Box, PM middle	100 pcs.	101 147

Article description	Content	REF
Assortment II, all 3 shapes assorted	100 pcs.	101 151

Autoclavable plastic impression tray

- Transparent, limited mouldability slightly heated, yet sturdy
- High retention of the impression material is obtained by special "retention baskets"
- Practical: can be labelled with felt-tip pen
- Available in three sizes

Article description	Size	Content	REF
Set sortiert		6 pcs. (je 3 x OK/UK)	101 155
Upper, AS 1	small	6 pcs.	101 156
Upper, AS 2	medium	6 pcs.	101 157
Upper, AS 3	large	6 pcs.	101 158
Lower, AI 1	small	6 pcs.	101 160
Lower, AI 2	medium	6 pcs.	101 161
Lower, AI 3	large	6 pcs.	101 162

AS = Autoclavable Superior AI = Autoclavable Inferior

Adhesive spray

- Ideal spray bonding agent for impression trays
- For better adhesion of the impression material to both, plastic and metal trays
- Use only in combination with impression material

Article description	Content	REF
Miratray Spray	225 ml	554 210

Miratray® Mini



Miratray® Partial



Assortment II

100 partial trays in three shapes, assorted:
 Shape: PL PR PM
 Quantity: 33 33 34

Miratray® 140°



Miratray® Spray



Algilock®



Algilock® Perforated



Algilock® Cleaner Plus



Extremely durable impression tray

- For dentulous jaws
- High-quality, corrosion-resistant stainless steel
- High durability, highest shape stability and long-term good appearance
- "Retention rims" hold the impression material without adhesives
- Laser-welded handles and ridges for a solid interconnection
- Autoclavable without loss of quality
- Only Algilock offers such a unique model variety and solid top quality
- On request, Algilock is available for maxilla and mandible as:
 - Algilock partial (perforated/non-perforated)
 - Algilock pedo (orthodontology)
 - Algilock edentulous (perforated)

Article description	Size	USA	REF
Upper, BS 5	xx-large	U11	101 006
Upper, BS 3	x-large	U12	101 004
Upper, BS 2A	large	U13	101 042
Upper, BS 2	medium	U14	101 003
Upper, BS 1	small	U15	101 002
Lower, BI 5	xx-large	L11	101 011
Lower, BI 3	x-large	L12	101 009
Lower, BI 2A	large	L13	101 043
Lower, BI 2	medium	L14	101 008
Lower, BI 1	small	L15	101 007
Set mit 10 trays (5 upper, 5 lower)			101 001

BS = Dentulous Superior BI = Dentulous Imperior

Article description	Size	USA	REF
Upper, PS 6	x-large	7	101 036
Upper, PS 5	large	5	101 034
Upper, PS 4	medium	4	101 033
Upper, PS 3	small	1	101 032
Lower, PI 6	x-large	24	101 041
Lower, PI 5	large	22	101 039
Lower, PI 4	medium	21	101 038
Lower, PI 3	small	20	101 037
Set mit 8 trays (4 upper, 4 lower)			101 031

PS = Perforated Superior PI = Perforated Imperior

Alginate remover

- Cleaning in dipping bath without mechanical impact, no ultrasound, no scratching
- Decomposes the organic structure of the impression material, no aggressive or caustic effect, no corrosion
- Even after several cleanings impression trays do not tarnish
- Bio-degradable and pH-neutral, phosphate-free, pleasant smell
- For approx. 500 trays

Easily removes plaster and alginates from impression trays, instruments and spatulas. No laborious and time-consuming cleaning, simply add 50 g to one litre of warm water and leave for approx. 15 – 30 minutes. May also be used in an ultrasonic unit. Not suitable for aluminium trays.

Article description	Content	REF
Algilock Cleaner Plus	1000 g	554 104

Fine application tips

- For precise application of liquids and pastes
- Bendable ends for hard-to-access areas
- Economic use of expensive materials (such as bondings, medicaments, etc.)
- Acid-resistant against bonding and other materials
- Hygienic dispenser box for single removal
- Available in three sizes

Article description	Content	REF
Medium – regular, blue handle	100 pcs.	605 510
Medium – regular, blue handle	5 x 100 pcs.	605 511
Fine – fine, white handle	100 pcs.	605 512
Fine – fine, white handle	5 x 100 pcs.	605 513
Conical – conical, green handle	100 pcs.	605 514
Conical – conical, green handle	5 x 100 pcs.	605 515
Apply-Tips dispenser for 500 pcs.	unfilled	605 516

Bendable application brush

- One-piece disposable brush
- Bendable: can be bended into any angle
- Time-saving: no changing of brushes
- Safe: no danger of cross infection
- Yellow handle = pointed brush, exact application
- Blue handle = flat brush, larger surfaces

Dispenser pack

Article description	Content	REF
Regular 10 cm, yellow/pointed	100 pcs.	605 460
Regular 10 cm, blue/flat	100 pcs.	605 461

Adhesive application aid

- Bendable stick with adhesive wax tip
- Ideal for quick and precise pick-up of crowns, inlays, veneers



Article description	Content	REF
Pick up Stick	30 pcs.	605 423

Apply-Tips®



with dispenser aid



Mirabrush®



Pick up Stick



Application

Standard

- Miraject P (Carpule)**
REF 254 206 | 0.8 x 25 mm/21G
- Miraject P Super (Carpule)**
REF 254 207 | 0.9 x 32 mm/20G
- Miraject PL Super (Luer)**
REF 254 214 | 0.9 x 22 mm/20G
- Miraject Endo Luer**
REF 254 222 | 0.3 x 40 mm/30G
- Miraject Endo Luer**
REF 254 215 | 0.5 x 40 mm/25G

Endotec Luer

- Miraject Endotec Luer**
REF 254 216 | 0.8 x 25 mm/21G
- Miraject Endotec Luer**
REF 254 217 | 0.6 x 25 mm/23G
- Miraject Endotec Luer**
REF 254 218 | 0.5 x 25 mm/25G
- Miraject Endotec Luer**
REF 254 228 | 0.4 x 25 mm/27G
- Miraject Endotec Luer**
REF 254 219 | 0.3 x 25 mm/30G

Endotec Luer Duo

- Miraject Endotec Duo**
REF 254 230 | 0.6 x 25 mm/23G
- Miraject Endotec Duo**
REF 254 231 | 0.5 x 25 mm/25G
- Miraject Endotec Duo**
REF 254 232 | 0.4 x 25 mm/27G
- Miraject Endotec Duo**
REF 254 233 | 0.3 x 25 mm/30G

Injection

Carpule

- Miraject 17/42***
REF 254 200 | 0.5 x 35 mm | 25G
- Miraject 17/23***
REF 254 201 | 0.5 x 21 mm | 25G
- Miraject 30/42***
REF 254 202 | 0.4 x 35 mm | 27G
- Miraject 30/23***
REF 254 203 | 0.4 x 21 mm | 27G
- Miraject 40/23***
REF 254 204 | 0.3 x 21 mm | 30G
- Miraject 40/10**
REF 254 205 | 0.3 x 10 mm | 30G

Luer

- Miraject Luer 17/42**
REF 254 210 | 0.5 x 42 mm | 25G
- Miraject Luer 17/23**
REF 254 211 | 0.5 x 23 mm | 25G
- Miraject Luer 30/42**
REF 254 212 | 0.4 x 42 mm | 27G
- Miraject Luer 30/23**
REF 254 213 | 0.4 x 23 mm | 27G

Canula for paste-like materials

- Blunt, bendable and individually sterile packed
- For cylinder ampoules
- Colour-coded

Pack with 100 pieces

Type	∅	Gauge	Length	REF
Miraject P	0.8 mm	21	25 mm	254 206
Miraject P Super	0.9 mm	20	32 mm	254 207

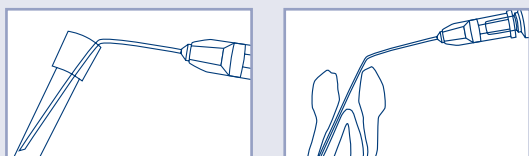

Short blunt Luer application canula

- For application of liquids, gels and for rinsing wider root canals
- Sterile packed
- Bendable
- For syringes with Luer tip

Pack with 100 pieces

Type	∅	Gauge	Length	REF
Miraject PL Super	0.9 mm	20	22 mm	254 214

Long blunt Luer application canula

- Application of liquids and pastes into the root canal
- Finest controllable measures
- In two sizes: 0.3 mm (30 gauge) and 0.5 mm (25 gauge), easy-to-insert into the root canal
- For syringes with Luer tip
- Colour-coded

Pack with 100 pieces

Type	∅	Gauge	Length	REF
Miraject Endo Luer, fine	0.3 mm	30	40 mm	254 222
Miraject Endo Luer, medium	0.5 mm	25	40 mm	254 215

Miraject® P / P Super

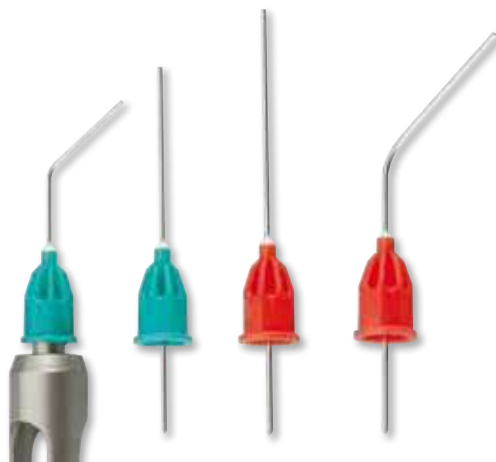
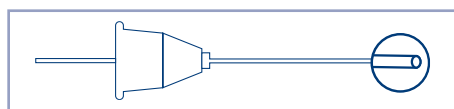

Miraject® PL Super

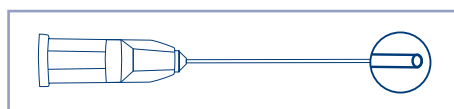

Miraject® Endo Luer

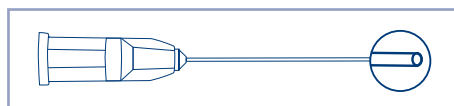

Miraject® Endo Rinse

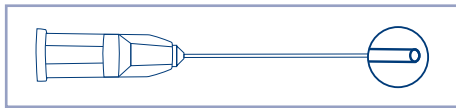

Convenient rinsing system for root canals, etc.

- Consisting of disposable syringe and blunt canula, sterile packed
- Syringe: for 3 ml liquid, with 1/10 ml calibration
- Canula: blunt, fine, long and bendable canula (0.5 mm/25 G x 32 mm)

Pack with 50 disposable syringes and 50 canulas

Type	∅	Gauge	Length	REF
Miraject Endo Rinse	0.5 mm	25	40 mm	254 220

Miraject® Endotec Luer

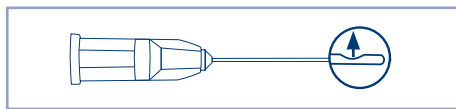

Special canula for rinsing with lateral opening

- Extra gentle, effective rinsing process
- Lateral opening avoids pressure on the apex
- Round canula end – low perforation risk
- Also ideal for gentle rinsing of periodontal pockets
- Sterile packed
- For syringes with Luer tip
- Colour-coded



Pack with 25 pieces

Type	∅	Gauge	Length	REF
Miraject Endotec Luer	0.8 mm	21	25 mm	254 216
Miraject Endotec Luer	0.6 mm	23	25 mm	254 217
Miraject Endotec Luer	0.5 mm	25	25 mm	254 218
Miraject Endotec Luer	0.4 mm	27	25 mm	254 228
Miraject Endotec Luer	0.3 mm	30	25 mm	254 219

Miraject® Endotec Duo

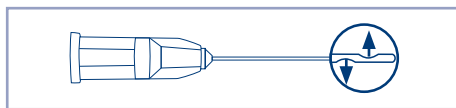

Special canula with two lateral openings

- Extra gentle, effective rinsing process
- Two lateral openings avoid pressure on the apex
- Round canula end – low perforation risk
- Also ideal for gentle rinsing of periodontal pockets
- Sterile packed
- For syringes with Luer tip
- Colour-coded

Pack with 25 pieces

Type	∅	Gauge	Length	REF
Miraject Endotec Duo	0.6 mm	23	25 mm	254 230
Miraject Endotec Duo	0.5 mm	25	25 mm	254 231
Miraject Endotec Duo	0.4 mm	27	25 mm	254 232
Miraject Endotec Duo	0.3 mm	30	25 mm	254 233

The injection canula on the dental market

- The classic disposable canula for cylinder ampoules
- Has been the hallmark of quality for more than 45 years: over 400 million Miraject canulas meeting highest quality standards
- Manufactured under strictest quality controls
- Meets the highest requirements of injection hygiene, every needle having a sterility control seal
- Triple lancet cut – almost painless
- Injection mark – orientation
- Silicone coating – ideal gliding behaviour
- Convenient handling and waste disposal
- \varnothing 0.5mm = red seal, \varnothing 0.4 mm = yellow seal, \varnothing 0.3 mm = green seal
- Colour-coded

Tip: Compatible with the Miramatic safety syringe system

Pack with 100 pieces

Type	\varnothing	Gauge	Length	REF
17/42	0.5 mm	25	35 mm	254 200
17/23	0.5 mm	25	21 mm	254 201
30/42	0.4 mm	27	35 mm	254 202
30/23	0.4 mm	27	21 mm	254 203
40/23	0.3 mm	30	21 mm	254 204

Short canula for intraligamentary anaesthesia (not suitable for the Miramatic system):

Type	\varnothing	Gauge	Length	REF
40/10	0.3 mm	30	10 mm	254 205



Injection canula with plastic Luer cone

- For injection solutions from an ampoule
- For any conventional disposable syringe
- Individually and sterile packed
- Colour-coded

Pack with 100 pieces

Type	\varnothing	Gauge	Length	REF
17/42	0.5 mm	25	42 mm	254 210
17/23	0.5 mm	25	23 mm	254 211
30/42	0.4 mm	27	42 mm	254 212
30/23	0.4 mm	27	23 mm	254 213

Miraject®

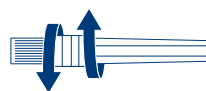

With paper seal

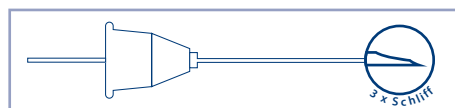

Miraject® Luer

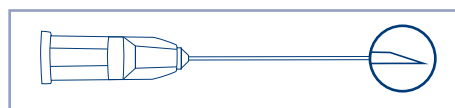

Miramatic®

Innovative safety syringe system with single-handed operation

- "No-touch system": No risk for the dentist and assistant to come into direct contact with the blood- and saliva-contaminated needle
- No risk of infection with HIV, hepatitis and other germs because of "re-capping" or disposing used canulas
- No injury risk from used canulas
- No screwing on and off necessary, more than 70% time saving

Further information on www.miraject.de

The Miramatic Safety-Set: 1 syringe, 3 boxes, 1 table fixing device and 1 Pack of Miraject-needles (Typ 30 / 23)

Article description	REF
Set with 1-ring syringe	355 471
Set with 3-ring syringe	355 469
Set with T-handle syringe	355 473
Set with Miramatic Aspi	355 496

plopp

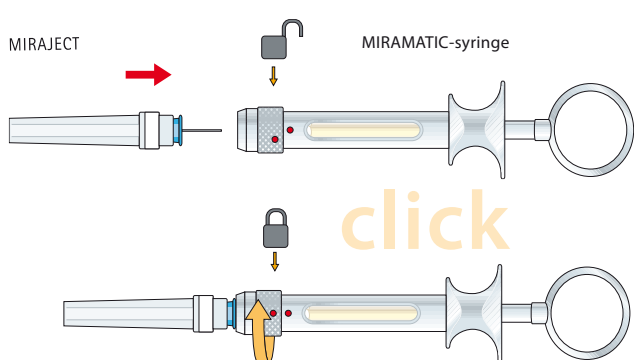
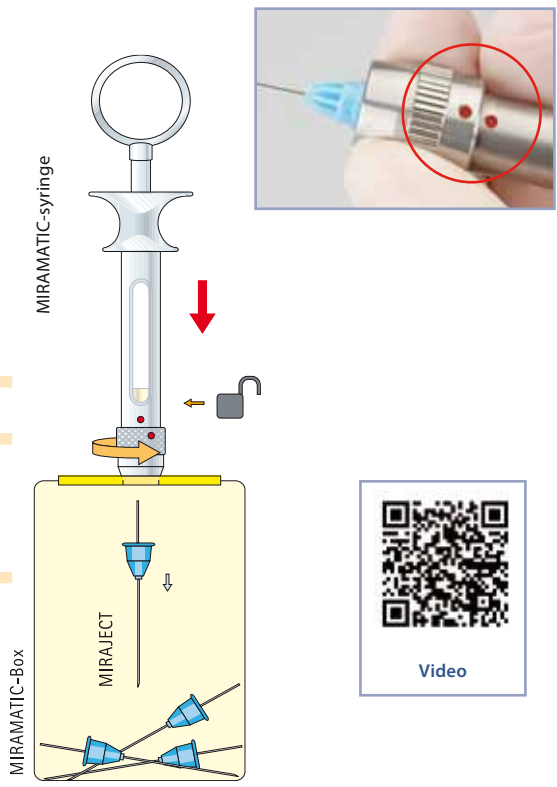

"The "No-touch-system" has convinced me. In our practice we have been familiar with the risk of getting into contact with blood- and saliva contaminated needles for many years and have reduced the risk of infection to a minimum. Following the injection, the safety stand ensures that the syringe is on hand and can be disposed of contact-free + stored safely after use."
Dr. Gabriele Schmeichel, Lückstedt



Makes it easy to adhere to the EU-Directive 20/32/EU regarding prevention of injuries caused by sharp/pointed instruments.

Miramatic®-Box

Patented disposal box

- With automatic lid, opening itself at the push of a button
- Disposal of used canulas and other products contaminated with blood and saliva, such as scalpels, disposable syringes and similar
- Absolutely safe storage due to firmly fixed lid with safety lock
- Opening for unlocking the Miramatic syringe and for disposal of the Miraject canulas
- The opening can be enlarged gradually by pushing out the flap
- Table fixing device for firm placing of the box

Article description	REF
5 boxes, 1 table fixing device	355 468
Table fixing device, separately	355 472



Syringes for the Miramatic system

- Entirely made of stainless steel with three handle designs available
- Matt finish surfaces prevent reflections and protect against scratches
- With aspiration potential
- Autoclavable

Article description	REF
1-ring	355 464
3-ring	355 467
T-handle	355 474
Miracare instrument oil 100 ml	554 112

We recommend Miracare instrument oil for maintaining the Miramatic head.

Self-aspirating syringe for the Miramatic system

- For conduction and infiltration anaesthesia
- Without aspiration hook, no tension at the syringe flask in counter direction
- Aspiration by light pressure/release of the syringe flask
- Autoclavable

Article description	REF
Miramatic Aspi	355 495

Solid safety stand for injection syringes and rinsing canulas

- No risk of injury from needles lying open on the cart
- One-hand re-capping reduces injury risk
- Syringe sits upright in its own protective cover
- Fixing clamp holds the protective cover tightly
- Stainless steel, approx. 220 g

Tip: Perfect complement to the Miramatic system

Article description	REF
Miramatic Holder Plus	355 466

Miramatic® Syringes



Miramatic® Aspi



Miramatic® Holder Plus



Fit® Rubberdam Starter Kit I



Fit® Rubberdam Starter Kit II

Fit® Rubberdam Perforating Template



Fit® Rubberdam Clamp Board



Fit® Rubberdam Forceps



Basic equipment no. I for rubber dam technique

- 1 Board with 12 clamps complete
- 1 Fit clamp forceps
- 1 Fit punch
- 1 Fit steel frame large
- 1 Fit Rubberdam brochure

Article description	REF
Fit-Rubberdam Starter Kit no. I	355 320

Basic equipment no. II for rubber dam technique

- 1 Board with 12 clamps complete
- 1 Fit clamp forceps
- 1 Fit punch
- 1 Fit latex medium (36 sheets)
- 1 Fit folding frame (plastic)
- 1 Perforated template
- 1 Fit Rubberdam brochure

Article description	REF
Fit-Rubberdam Starter Kit no. II	355 338

For making the holes in rubber dam prior to perforation

- Solid plastic

Article description	REF
Fit Rubberdam Template, 15 x 15 cm	355 318

Clamp board available with and without clamps

Stainless steel board, with 8 clamps

2 x No. 9, 1 x each: Nos. 2A, W2A, 5, 56, 203, 2044

Stainless steel board with 12 clamps

1 x each: Nos. 5, 7, 56, 201, 202, 206, 207, 210, 211, 0, 2, 2A

Stainless steel board with 18 clamps

j1 x each: Nos. P1, P2, 18, 22, 27, 29, 200, 201, 202, 203, 204, 205, 208, 209, 138, 139, 210, 211

Article description	REF
Clamp Board with 8 clamps	355 330
Clamp Board with 12 clamps	355 331
Clamp Board with 18 clamps	355 332
Clamp Board without clamps (for 8 clamps)	355 327
Clamp Board without clamps (for 12 clamps)	355 328
Clamp Board without clamps (for 18 clamps)	355 329

Fit® Clamp Forceps – for smooth grasp of the clamps

- Arbitrarily fixable
- No tilting of clamp

Fit® Punch – for perfectly punched, tearproof perforations

- Movable punching pin constantly using the whole cutting border
- Made of stainless steel

Article description	REF
Fit Punch	355 321
Fit Clamp Forceps	355 333

Made of natural latex rubber

- Medium: extra smooth-running due to approximal contact
- Heavy: for a stronger retention of the gingival
- High tensile strength due to constant quality
- Durability one year minimum, if stored in a cool place
- Green sheets (15 x 15 cm), powdered on one side

Article description	Thickness	Content	REF
Fit Latex Medium	0.18–0.23 mm	36 sheet	355 335
Fit Latex Heavy	0.23–0.29 mm	36 sheet	355 336

For an easier and quicker insertion of the Fit Rubberdam-Latex in case of close contact points we recommend using our Miradont-Gel (page 48) as lubricant.

Specifically for widening of interdental spaces for a short time

Article description	REF
Eliot Separator	355 325

Solid stainless steel frame

- For tightening of rubber dam without perforation
- Autoclavable

Article description	REF
Frame I = large	355 324
Frame II = small	355 323

Foldable plastic frame

- Foldable in the center, easy access
- Avoid reflections when taking X-rays, ideal for endodontics
- Autoclavable

Article description	REF
Folding frame	355 319

Fit® Rubberdam-Latex



Fit® Rubberdam Eliot Separator



Fit® Rubberdam Steel Frame

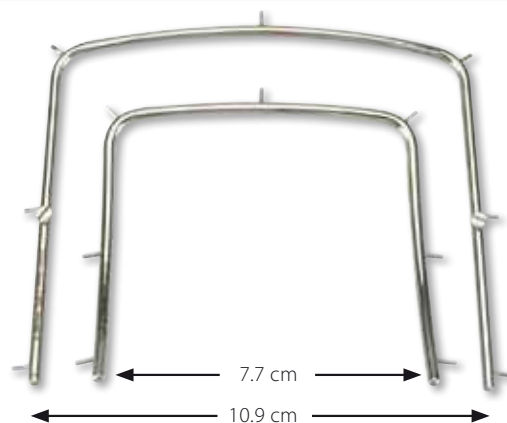

Fit® Rubberdam Folding Frame



Fit® Rubberdam Clamps

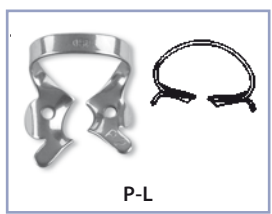
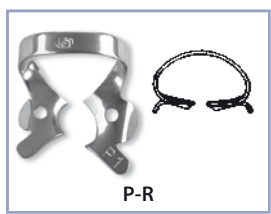
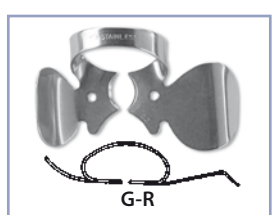
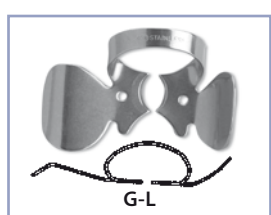
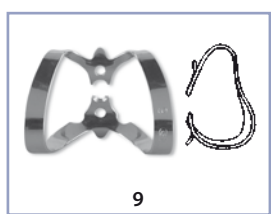
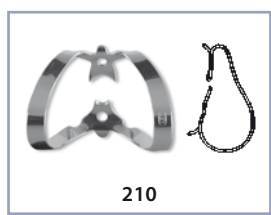

Fit® Rubberdam Clamps Black



Cervical Clamp 214



Our Fit Rubberdam clamps are made of stainless steel and every single one is adjusted exactly, precisely and effectively for the tooth it is intended for. 0.66 mm thick stainless steel is used for the high quality.

Ivory style (labial)

Article description	REF
210	355 384
211	355 385
9	355 355

Ivory style (cervical)

Article description	REF
212	355 386

With cotton roll holder

Article description	REF
Set with clamps G-L and G-R	355 389

For children R + L

- For the first permanent molars

Article description	REF
P-R	355 387
P-L	355 388

None-reflecting black rubberdam clamps

- Dull surface blocks irritating light reflexes
- Glare-free when working with loops or intraoral cameras
- High quality stainless steel

Article description	REF	Article description	REF
No. 0	355 770	No. 201	355 779
No. 2	355 771	No. 202	355 780
No. 2a	355 772	No. 206	355 781
No. 5	355 773	No. 207	355 782
No. 7	355 774	No. 210	355 783
No. 8a	355 775	No. 211	355 784
No. 56	355 776	No. 1AT	355 785
No. 138	355 777	No. 14T	355 786
No. 139	355 778		

Special clamp

- For exposure of the tooth neck and for temporary retraction of the gingiva
- Screw fixation guarantees a firm grip
- Ideal e.g. for adhesive fixing of veneers

Article description	REF
Cervical Clamp 214	355 400

Specified rubber dam clamps

- For the labial, premolar and molar area
- With special retentions for a better fixing at the tooth

Labial T-clamp

Article description	REF
9T	355 754

Premolar T-clamps

Article description	REF
1T	355 752
1AT	355 753
2T	355 750
2AT	355 751

Free booklet available!



Molar T-clamps

Article description	REF
14T	355 758
56T	355 759

Special Rubberdam clamps for children

- Especially designed for the anatomic shape of deciduous teeth
- Ideal for pediatric dentistry

Article description	Quadrant	REF
55E	upper right	355 723
54D	upper right	355 722
64D	upper left	355 724
65E	upper left	355 725
85E	lower right	355 729
84D	lower right	355 728
74D	lower left	355 726
75E	lower left	355 727
Kit with 8 clamps on a clamp board		355 720
Clamp board separately, without clamps		355 721

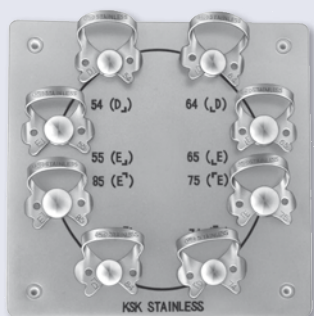

Fit® Rubberdam Clamps



Fit® Rubberdam Clamps for Children



Fit® Rubberdam Clamps

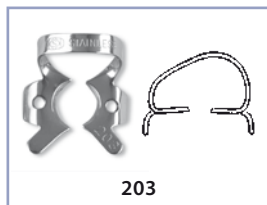
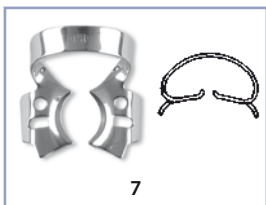
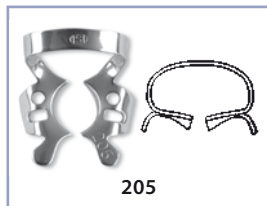
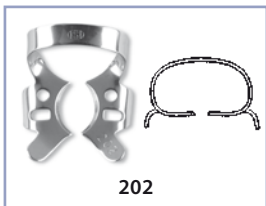
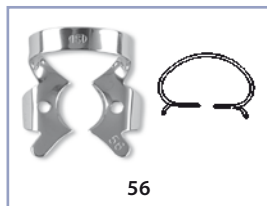
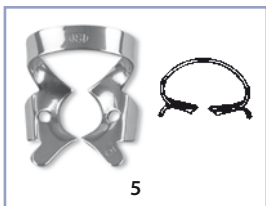
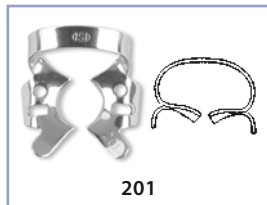
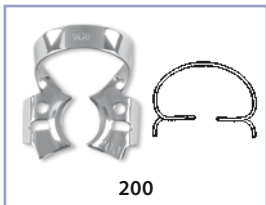
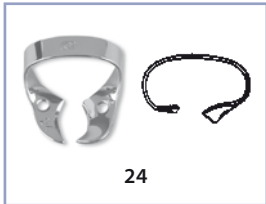
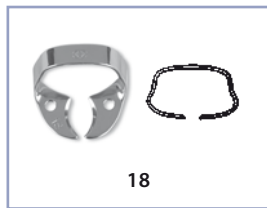
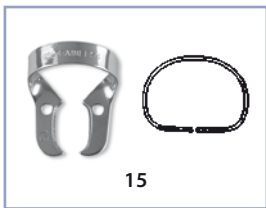

Molar clamps wingless

Article description	REF
15	355 358
18	355 359
24	355 361
25	355 362
26	355 363
28	355 365
30	355 367
31	355 368
51	355 369
138	355 372
139	355 373
W8A	355 354



Molar clamps with wings

Article description	REF
200	355 374
201	355 375
5	355 349
56	355 370
202	355 376
205	355 379
7	355 350
203	355 377
204	355 378
7A	355 351

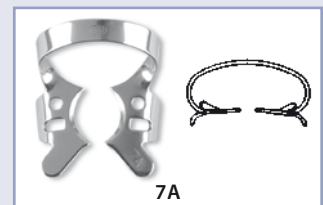
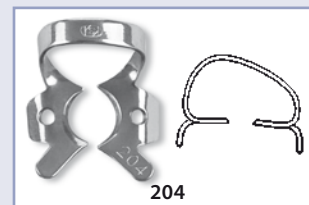

Molar clamps with wings (for deep gripping)

Article description	REF
3	355 346
4	355 348
8	355 352
8A	355 353
14	355 356
14A	355 357

Should the friction of the clamp be insufficient, an activation, e. g. with pointed forceps, is possible.

Premolar clamps wingless

Article description	REF
W2A	355 345
22	355 360
27	355 364
29	355 366

Our Fit Rubberdam clamps are made of stainless steel and every single one is adjusted exactly, precisely and effectively for the tooth it is intended for. 0.66 mm thick stainless steel is used for the high quality.

Premolar clamps with wings

Article description	REF
00	355 341
0	355 340
206	355 380
207	355 381
209	355 383
208	355 382
2	355 343
2A	355 344

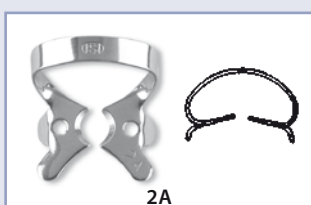
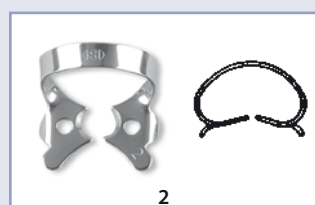

Fit® Rubberdam Clamps

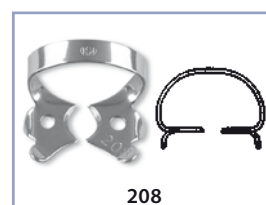
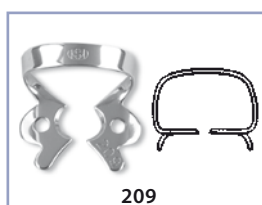
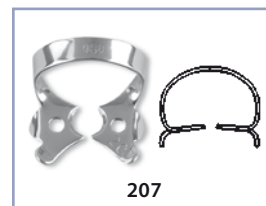
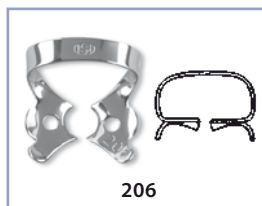
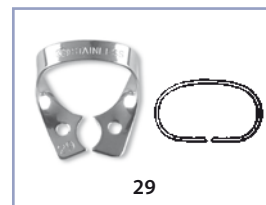
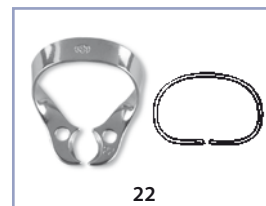
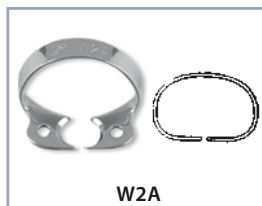

Perfect Splint C®



Pre-manufactured splinting nets in four sizes

- For splinting, stabilisation and interim provision
- Time-saving: easy-to-adapt and fix by bow shape
- The size of the dental bow to be treated can be determined fast and safely by the curved archetypes (dummies), 98 % fitting-accuracy



User Report

Article description	Content	REF
Combi set stainless steel/plastic (PET)	8 pcs. each	153 000
Set stainless steel	8 pcs.	153 001
Set plastic (PET)	8 pcs.	153 002

Refill packs with 10 bows and dummies available on request.

Perfect Splint-System

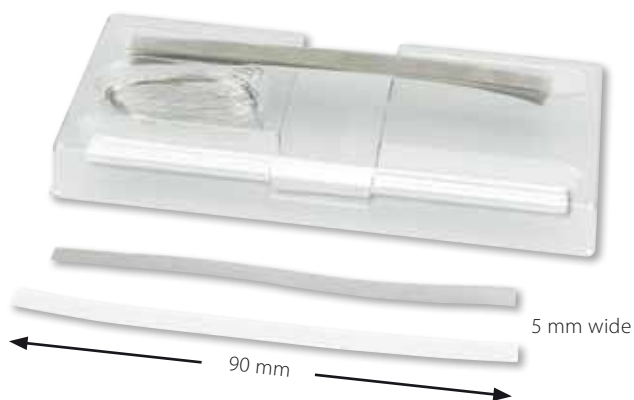

Straight splinting nets

- Cuttable plastic (PET) or stainless steel nets for splinting
- Each pack sufficient for the splinting of approx. 200 teeth

Complete pack

Article description	REF
10 stainless steel and plastic (PET) nets each, attachment aid (orthodontic wire)	152 280

Single packs

Article description	REF
20 stainless steel nets, attachment aid (orthodontic wire)	152 281
20 PET nets, attachment aid (orthodontic wire)	152 282

Super-Splint De Luxe



Multilayer splinter material

- 6 sewed on layers of fine meshed, ultra-thin and silanised glass fibre tape
- 4 mm wide, for approx. 25 applications

Article description	REF
Super-Splint De Luxe, 50 cm tape	355 848

Glass fibre tape for splinting and strengthening

- Extremely flexible, easy-to-adapt, very easy to handle and apply
- Several layers of the tape may be arranged on top of each other with composite
- 4 mm wide, silanised tape, for up to 50 applications

Article description	REF
Super-Splint, 3 m tape	355 849

Super-Splint

Fissure stamp for composite fillings

- Easy, good and fast occlusal modulation of lateral composite fillings
- No more manual modulation of the occlusal surfaces
- Translucent plastic, may be disinfected
- Polymerisation by placing the lamp onto the stamp
- Molar and premolar disposable stamp in 16 different sizes and shapes, separated into upper/lower jaw and right/left jaw
- The tooth number is stated on the stamp top for an easy identification

Article description	REF
Intro kit with 32 stamps (16 x 2 pcs.)	605 494
Set with 160 stamps (16 x 10 pcs.)	605 477

Refills with 10 pcs. each available separately in 16 sizes

37% phosphoric acid

- Viscous gel
- Dyed red for better visualisation on the enamel
- Easily measured from the syringe
- For approx. 30 applications

Further application needles: Miraject Endo Luer (see page 16)

Article description	REF
2ml syringe with 2 canulas	152 284

Ready for use calcium hydroxide paste (45 %)

- For direct capping after opening of the pulp or in case of pulptomy, indirect capping in case of caries profunda
- For temporary root canal fillings and root canal disinfections
- High pH-value (over 11.5) for antimicrobial effect, radiopaque
- Economic and easy-to-measure
- Appropriate underneath all underfilling and filling materials
- Incl. curing-aid cap

Further application needles: Miraject Endo Luer (see page 13)

Article description	REF
2ml syringe with 2 canulas	152 283

Matrix retainer "Tofflemire" style

- High-quality stainless steel
- Autoclavable



Article description	REF
Standard universal No. 1	355 043
Angled No. 2	355 047
Junior (short) No. 3	355 048

Occlu-Print

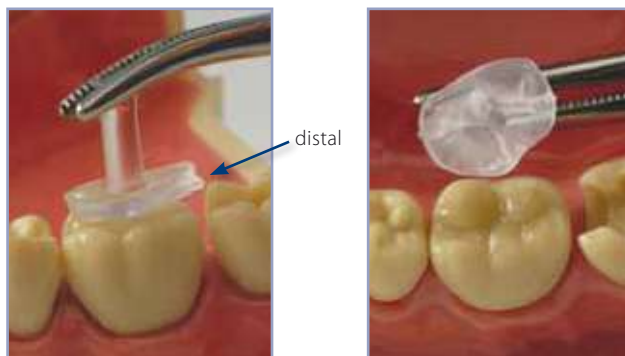

Micro-Etch



Calci-Line®



Matrix-Retainers



Crown Click® De Luxe



Mechanical crown and bridge remover

- Very effective due to impulse wave
- Just place the instrument tip underneath the crown rim and release the "click"
- Instrument tip in three designs with additional loop (optional)
- Fast, efficient and easy crown and bridge removal
- High-quality, mattfinished stainless steel, autoclavable

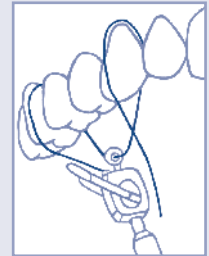

Article description	REF
Set: instrument with tips (No. 1 –3)	452 205
Tip No. 1 (long)	452 206
Tip No. 2 (short)	452 207
Tip No. 3 (short + angle)	452 208
Loop tip No. 4 (incl. adapter)	452 209
Loop tip replacement wire, 2 pcs.	452 210

C-EX® / B-EX®



Gripping clamp for removal of crowns and bridges

- High-quality chromium-nickel alloy
- No tilting possible
- B-EX with pointed tip for bridges
- C-EX with broad tip for crowns
- Autoclavable



Article description	REF
Bridge remover	355 203
Crown remover	355 204

Gripit®



Bite cushion with high adhesion force

- For removal of temporary work
- Heat bite cushion, put in place and remove temporary work by instructing the patient to open his mouth jerkily
- Safe and very convenient for the patient
- Two pieces hygienically packed

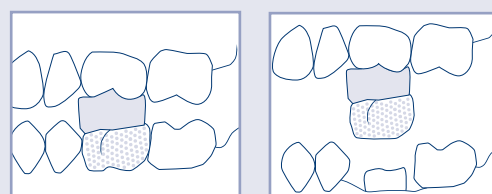

Article description	Content	REF
Gripit	50 (25 x 2) pcs.	605 283

High-quality green occlusion spray

- For marking of contact points by direct spraying onto the occlusal surfaces
- Micro powder layer for highest accuracy
- Plastic nozzle for extra fine spray mist
- Powder layer can be easily removed with water
- Economic in consumption

Article description	Content	REF
Aerosol can green	75 ml	554 205
Aerosol can green	50 ml	554 211
Aerosol can red	50 ml	554 215

Marking instrument

- With green marking tip
- For markings on the oral mucosa (A-line, pressure marks, fracture lines, crown margins, etc.) before taking an impression

Article description	REF
Instrument with 5 green marking tips	355 315
5 green marking tips separately	355 316

For checking interdental contact points

- Holder made of stainless steel
- Strong stainless steel contact tapes
- In three colour-coded thicknesses

Article description	REF
Set with holder and 1 tape each	355 306
Replacement band separately, blue \varnothing 0.05 mm	355 307
Replacement band separately, red \varnothing 0.11 mm	355 308
Replacement band separately, yellow \varnothing 0.15 mm	355 309

Amalgam depot made of stainless steel

- Funnel-shaped for easy pick-up
- Allows pick-up of amalgam without skin contact
- Stable and non-slip (123 g), autoclavable

Article description	REF
Amalgam Well	355 000
Del-Ject, plastic amalgam carrier, 90° angle	355 036

Plastic caps for core build-up

- Time-saving as modelling of the cured core is simplified
- Cost-saving as significantly less composite is needed
- Minimised risk of accidental damage to neighbouring teeth
- Standard shape of caps suits any core build-up
- Transparent and light conducting caps in six sizes
- Thin-walled caps can simply be adapted with scissors
- May basically be used with any commercial root canal post system and core build-up composite

Article description	REF
Kit of 72 with 12 caps each in 6 sizes	605 470

Refill kits with 10 caps per size on request

Occlu® Spray Plus



Exact Liner



Contact Gauge



Amalgam Well



Mirafit® BC

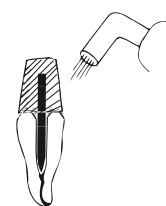
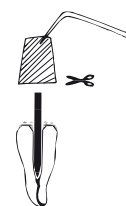

Mirafit® 3 in 1

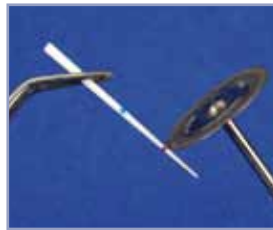

Build-up post from white glass fibre

- Biocompatible material, physical properties similar to dentine
- Thread-free, gentle to the tooth substance, radiopaque
- Cone-shaped, size may be adjusted individually with the aid of three colour marks on the post:
 - Yellow mark: Post length 2.9 mm, approx. ISO size 60
 - Red mark: Post length 8.25 mm, approx. ISO size 80
 - Blue mark: Post length 17.5 mm, approx. ISO size 110 (overall post length 35 mm)

Article description	REF
Kit: 6 posts, 1 depth reamer and 3 root canal reamers	356 074

Refill packs

Article description	Content	REF
Posts	6 pcs.	356 080
Depth reamer	3 pcs.	356 081
Root canal reamer yellow, small	3 pcs.	356 082
Root canal reamer red, medium	3 pcs.	356 083
Root canal reamer blue, large	3 pcs.	356 084

Mirafit® Carbon and White

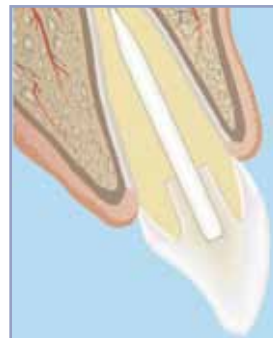
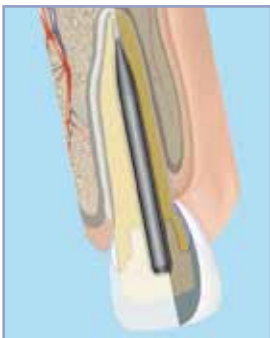

Thread-free reconstruction post made of carbon and glass fibre

- Physical properties of the post similar to those of dentine and reconstruction composite
- No risk of corrosion due to biocompatible metal-free material
- Preparation very gentle to the tooth substance
- Extra-long and easy to shorten post, can easily be removed by means of a bur
- Available in 3 conventional diameters:
 - L2 = Ø 1.20 mm
 - L3 = Ø 1.35 mm
 - L4 = Ø 1.50 mm

Mirafit Carbon

- Post visible on X-rays due to radiopaque cement

Mirafit White

- The white colour of the post meets high esthetical requirements
- Radiopaque

Article description	Content	REF
Mirafit Carbon kit	3 x 6 posts and 1 reamer each	356 040
Mirafit Carbon, post L2	Ø 1.20 mm, 6 pcs.	356 041
Mirafit Carbon, post L3	Ø 1.35 mm, 6 pcs.	356 042
Mirafit Carbon, post L4	Ø 1.50 mm, 6 pcs.	356 043
Mirafit White kit	3 x 6 posts and 1 reamer each	356 044
Mirafit White, post L2	Ø 1.20 mm, 6 pcs.	356 045
Mirafit White, post L3	Ø 1.35 mm, 6 pcs.	356 046
Mirafit White, post L4	Ø 1.50 mm, 6 pcs.	356 047
Mirafit reamer L2	3 pcs.	356 048
Mirafit reamer L3	3 pcs.	356 049
Mirafit reamer L4	3 pcs.	356 050

Fibre post system

- Highly radiopaque (35% AL) and light transmitting for the use of dual curing resin cements
- Conical shape with mechanical retention slots - with colour coding
- Aesthetic thanks to its translucent matrix
- 100% biocompatible- epoxy free

Article description	Content	REF
Intro kit, 4 x 5 posts + 4 reamers		357 000
Refill No. 1	10 pcs.	357 001
Refill No. 2	10 pcs.	357 002
Refill No. 3	10 pcs.	357 003
Refill No. 4	10 pcs.	357 004
Reamer No. 1	3 pcs.	357 005
Reamer No. 2	3 pcs.	357 006
Reamer No. 3	3 pcs.	357 007
Reamer No. 4	3 pcs.	357 008

Inexpensive build-up post

- Self-cutting thread
- In two versions: titanium or 24 carat gold-plated
- Gets directly screwed in or cemented
- In four lengths: short (8 mm), medium (9.5 mm), long (12 mm), x-long (14 mm)
- In six diameters: No. 1 (1.05 mm), No. 2 (1.20 mm), No. 3 (1.35 mm), No. 4 (1.50 mm), No. 5 (1.65 mm), No. 6 (1.80 mm)
- Sets include three, six or twelve posts per size



Gold-plated set with hollow and cross-type driver, titanium set with hollow driver

Article description	Content	REF
Set 240, gold-plated	20 x 12 pcs.	355 975
Set 120, titanium	20 x 6 pcs.	355 998
Set 60, gold-plated	20 x 3 pcs.	355 974
Set 60, titanium	20 x 3 pcs.	355 973

Reamer

Article description	∅	Content	REF
Set 1-6			355 997
No. 1	1.05	3 pcs.	356 020
No. 2	1.20	3 pcs.	356 021
No. 3	1.35	3 pcs.	356 022
No. 4	1.50	3 pcs.	356 023
No. 5	1.65	3 pcs.	356 024
No. 6	1.80	3 pcs.	356 025
Hollow driver, separately			356 027
Cross-type driver, separately			356 028

Mirafit® Clear



Intro Kit

Mira-Post®

Gold-plated

Titanium



	S (8 mm)	M (9,5 mm)	L (12 mm)	XL (14 mm)
Reamer NF (3er Pck.)				
No. 6 (∅ 1,80) 356 025	G 355 981 Ti 356 004	G 355 987 Ti 356 010	G 355 993 Ti 356 016	G 355 995 Ti 356 018
No. 5 (∅ 1,65) 356 024	G 355 980 Ti 356 003	G 355 986 Ti 356 009	G 355 992 Ti 356 015	
No. 4 (∅ 1,50) 356 023	G 355 979 Ti 356 002	G 355 985 Ti 356 008	G 355 991 Ti 356 014	G 355 994 Ti 356 017
No. 3 (∅ 1,35) 356 022	G 355 978 Ti 356 001	G 355 984 Ti 356 007	G 355 990 Ti 356 013	
No. 2 (∅ 1,20) 356 021	G 355 977 Ti 356 000	G 355 983 Ti 356 006	G 355 989 Ti 356 012	
No. 1 (∅ 1,05) 356 020	G 355 976 Ti 355 999	G 355 982 Ti 356 005	G 355 988 Ti 356 011	

Refill packs with 6 reamer in titanium or 12 reamers gold plated on request.

N2® Endodontic Cement



Interview



Control radiography

Root canal cement on zinc oxide – eugenol basis

- Inexpensive and fast alternative for more than 50 years
- Can be used separately or as a sealer in connection with Gutta Percha points
- Easily to be rotated into the canal
- Good adhesion to canal walls
- Definite, not absorbable filling with a chalk-like hardness after curing
- Antimicrobial effect gradually decreasing with curing
- Consisting of powder and liquid for mixing

Article description	Content	REF
Set	10 g powder, 6 g liquid	152 027
Pulver separately	10 g	152 028
Liquid separately	6 g	152 029

"In more than 8,800 EDP-registered vital extirpations in the period from 1985 – 1999 the treatment needed more than one session to be finished in only 22 cases (5 own, 17 assistant). I have not counted thousands of vital amputations and milk tooth endos."
Dr. Robert Teeuwen

Desmoclean®



Desmoclean original size (two shaft lengths and two head sizes)

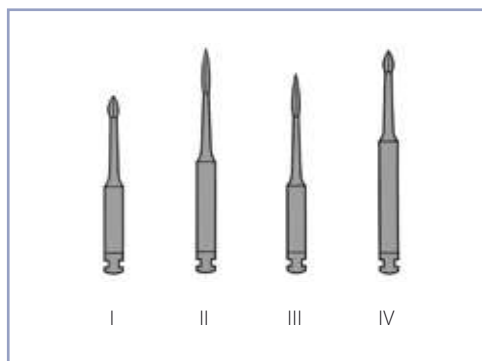

Instruments for gentle root planning

- For curettage of the root surface in deep pockets, for bi- and/or tri-furcation and in the approximal area
- For removal of tightly adhesive granulations
- For removal of concrement (subgingival plaque)
- For periost ablation during flap surgery
- Non-cutting hexagonal head – as gentle as a manually operated device and as fast as diamonds
- At least 30 – 50 periodontias can be treated per instrument
- To be used with 7,000 – 10,000 rpm with light pressure and water spray

Article description	REF
Intro kit with 6 pieces per shape (24 pieces)	503 290
Minikit with 1 piece per shape (4 pieces)	503 263
Set with 3 pieces per shape (12 pieces)	503 264

Single shapes

Article description	REF (3 pcs.)	REF (12 pcs.)
I	503 265	503 291
II	503 266	503 292
III	503 267	503 293
IV	503 268	503 294

Combination pack with 6 pieces each in 2 shapes

Article description	REF
I and II	503 295
I and III	503 297
II and IV	503 298
III and IV	503 296

The decisive weapon against periimplantitis

- Seals implant gaps and hollow spaces
- Durably stops infiltration of germs into the hollow spaces
- Eliminating risk of re-infection of periimplant tissue
- Effectively avoids a main reason for periimplantitis
- Successful 18-year clinical study of the University Düsseldorf, Germany
- Quick and easy handling and application
- Each carpule supports enough material for 2 – 3 implants



Article description	REF
GapSeal set (applicator + 10 tips)	152 041
GapSeal refill (10 tips, 0.06 ml each)	152 040
Applicator	152 042

Gap Sealing against Periimplantitis

Out of manufacturing constraints, gaps and hollow spaces between implant and structures are inevitable for all compound implants.

These gaps can be minimized depending on fabrication precision. However, they are never completely bacteria-proof and in an open connection with the bacteria- and fungi-settled oral cavity. The spectrum of germs settling in the hollow spaces consists of a large quantity of gram-negative, mostly anaerobic bacteria, as it is the case with periimplantitis. These humid and warm implant interiors offer an ideal milieu for bacteria growth and partly also cause fungi affection. Already 18 years ago, the Clinic for Oral and Maxillofacial Surgery of the Heinrich-Heine University, Düsseldorf, Germany under the direction of Prof. Dr. Dr. Fritzemeier has started to find a solution to this problem. The gap between abutment and implant averages „only“ 45 µm, whereas most of the relevant bacteria have a size of between 0.5 µm and 4 µm.

Based on extensive studies and tests, a material was developed sealing all capillary gaps and interior spaces of the compound implant bacteria-proof.

GapSeal is based on a special silicone matrix ingredient composition, which creates a barrier effectively preventing infiltration by bacteria. It is used directly after fitting of the implant with the first fixing of the locking screw. Therefore, the implant is durably protected against colonization by bacteria, viruses and fungi from the very beginning. GapSeal is most easy in application as the material is offered in small portion tips, together with a special applicator.

GapSeal seals the gaps and hollow spaces, which are to be found in every compound implant, thus effectively and durably avoiding colonization of germs into these hollow spaces and eliminating the risk of re-infection of the periimplant tissue, the main reason for periimplantitis.

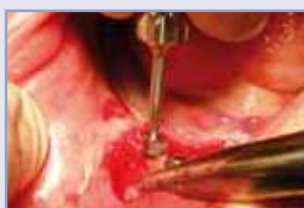

The implants are thoroughly covered with GapSeal immediately after they are placed, during the first turns of the locking screw.

GapSeal®

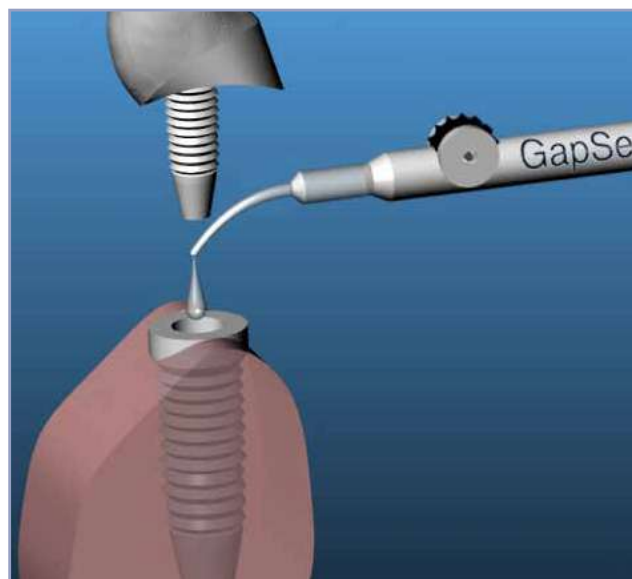

Video

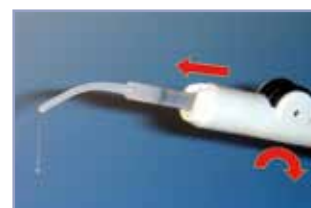
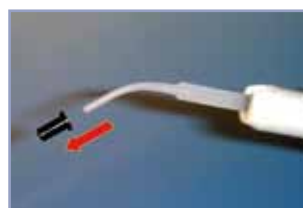

After removing the closure cap GapSeal is directly applied by simple turning the transport screw.

Miraclean-Implant Black



Cleaning instruments for implants

- Black coloured instruments for great contrast
- Double ended, in 4 special shapes
- Autoclavable and chemiclavable plastic material

Article description	REF
Set of 4 instruments	355 220
Instrument seperately: No. 1	355 221
Instrument seperately: No. 2	355 222
Instrument seperately: No. 3	355 223
Instrument seperately: No. 4	355 224

Miraimplant®



Parallel drilling aid for implants according to Dr. König

- Applicable for any implant system
- Parallel reciprocal implant adjustment
- Optional selection of implant positions in the horizontal according to surgical criteria
- Optimization of the prosthetic result
- Autoclavable

Article description	REF
Kit (incl. 1 pilot drill and 2 guide pins)	356 100
Pilot drill 2 mm	503 500
Guide pins 1.9 mm	356 101
Guide pins 2.0 mm	356 102
Guide pins 2.1 mm	356 103
Guide pins 2.2 mm	356 104

Miraglu®



Tissue adhesive for sealing of skin and mucosa injuries

- Excellent adhesive characteristics on humid tissue
- Cyano acrylate liquid in monomer form, polymerizes when getting into contact with water/body fluid
- Thin, absolutely dense film fixes wound borders tightly due to short setting time
- Wounds heal fast and without complications, no scarring, no need to take the stitches out, cosmetically impeccable
- Bactericidal and fungicidal effect, existing germ settlements get killed
- Suitable to cover up minor cuts

Article description	REF
Tube with 3 g, 20 fine dosing pipettes and 2 mixing dishes	155 015

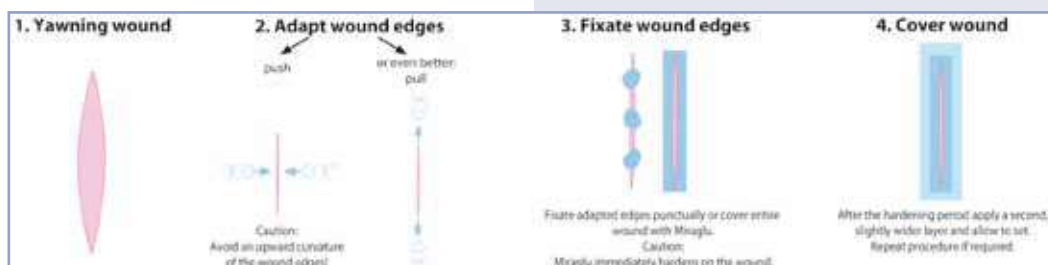

Adhesive periodontal dressing based on cellulose

- To be applied directly to wounds, sutures and pressure spots
- Keeps out bacteria and assists the healing process
- Remains up to 30 hours and is self-dissolving
- Ideal for protection of wounds and sutures in implantology, periodontics, following extractions, in orthodontics and prosthodontics
- Ideal as a medicament carrier
- Patient-friendly as it stays soft, is odourless and neutral in taste



Article description	Content	REF
Reso-Pac	25 g	155 011
Reso-Pac value pack	5 x 25 g	155 010
Reso-Pac single portions	50 x 2 g	155 014

Myrrh-benzoin tincture to support the wound healing

- Myrrh (tissue-firming and nurturing effect) helps in inflammations in the oral cavity and pharynx, in aftereffects of dental and gingival treatments, aphthae, etc.
- Benzoin and aloe have a nurturing healing effect
- Contains neither antibiotics nor corticosteroids
- No burning after application, pleasant taste, sticks to the mucosa for a long time due to its syrupy consistency
- After periodontal or surgical treatment
- For more than 100 applications

Article description	Content	REF
Myzotect-Tincture	50 ml	155 005

For the patient's use at home

Article description	Content	REF
Myzotect-Tincture	5 x 5 ml	155 006
Myzotect-Tincture	10 x 5 ml	155 007

For optimal periodontitis therapy

Dentosmin P contains 1 % chlorhexidine bis (D-gluconate) and is especially suitable for:

- supporting temporal treatment of bacteria caused gingival inflammation (Gingivitis)
- supporting healing after surgical parodontal treatments
- patients with restricted oral hygiene e.g. after maxillofacial treatment

Article description	Content	REF
Dentosmin P	15 g	155 021

For Miradont-Gel see page 48.

Reso-Pac®



Myzotect®-Tincture



Very effective in combination with Reso-Pac



Dentosmin® P



Composition:
1 g paste contains 10 mg chlorhexidinebis (D-gluconate) as active pharmaceutical ingredient. Further ingredients are: calciumpyrophosphate (cleaning bodies), hyetellose, saccharine, glycercole 85 %, silicon dioxide (for dental use), perfume oil, colorant E 131 (patent blue V), methyl-4-hydroxybenzoate (pH.Eur), purified water.

Medicinal product.

Variator®-Kit



Disposable treatment set

- Comprises mouth mirror, tweezers and probe
- Big spatula for mixing of cement and filling materials
- Ball head and Heidemann spatula for stuffing
- Practical for home visits, high-risk patients and in emergencies
- All three instruments are steril and blister-packed as a unit

Article description	Content	REF
Variator-Kit set	10 sets	355 441

Tweezer PL

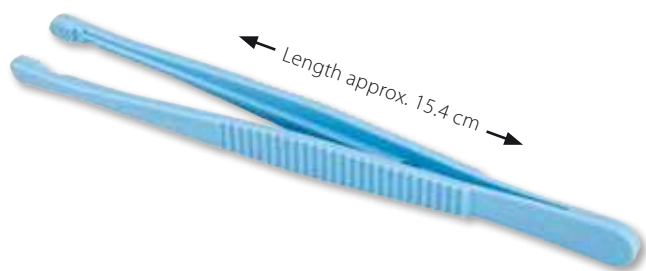

Special toothed plastic tweezers

- Optimal grip due to toothed "gripping field" in every direction
- For gripping of very thin fibres, e.g. dental floss
- Autoclavable

Article description	Content	REF
Tweezer PL	10 pcs.	355 202

Liftbox



Disinfection box for dental instruments

- By closing the cover, the filled tray submerges into the disinfectant
- Tray with swivel handle for easy handling
- No direct skin contact with aggressive disinfectants
- Acid-resistant plastic

Article description	Content	REF
Liftbox	1 pcs.	355 140

Cheek and lip retractor

- Allows a free view and working field
- Ideal for treatment of anterior teeth
- Made of non-reflecting plastic
- Autoclavable

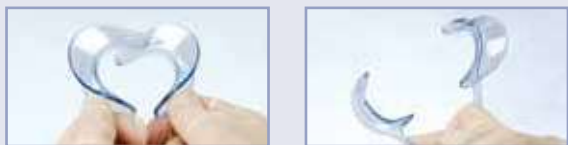

Article description	Content	REF
Regular	2 pcs.	605 454
Mini (children)	2 pcs.	605 455

Lip retractor

- Expands patient's mouth in vertical direction
- For treatment at the gingival border of anterior teeth
- Autoclavable

Article description	Content	REF
Spandex-Vertical (2 x medium, 2 x small)	4 pcs.	605 211

Disposable lip retractor

- Non autoclavable

Article description	Content	REF
Spandex-Vertical Eco (medium)	6 pcs.	605 255

One sided cheek retractor

- With long handle for a free working field
- Useful, e.g. for injections
- Convenient for the patient
- Autoclavable



Article description	Content	REF
Mirahold regular	2 pcs.	605 450
Mirahold bambino	2 pcs.	605 451

Elastic bite blocks for mouth opening

- Plastic block to keep the mouth open reliably
- The set includes a special cheek retractor
- Ideal for longer treatments and anxious patients
- Autoclavable

Article description	REF
Set with 12 bite blocks, 6 small and large each and 2 cheek retractors	605 210
Intro set with 6 bite blocks, 3 small and large each and 1 cheek retractor	605 238
Mini set with 3 bite blocks (small)	605 220
Cheek retractor separately	605 239

Spandex®



Spandex®-Vertical



Spandex®-Vertical Eco

Mirahold®



Mirahold® -Block



Brilliant Anti-Fog

ANTI-FOG

ø 19 mm



Brillant

ø 23 mm



Disposable anti-fog mouth mirror made of plastic

- With anti-fog coating
- Flat, angled mirror head for access to all areas in the oral cavity
- Ergonomic finger-grip handle
- Each mirror protected with foil and single packed
- For control of dental care at home

Article description	Content	REF
White, ø 19 mm	50 pcs.	605 416
Transparent blue, ø 19 mm	50 pcs.	605 417
Transparent pink, ø 19 mm	50 pcs.	605 418

Disposable mouth mirror made of plastic

- Without anti-fog coating
- Available in two sizes, ø 19 mm and ø 23 mm
- Each mirror protected with foil and single packed, 100 pieces

Article description	Content	REF
No. 4, white, ø 19 mm	100 pcs.	605 400
No. 5, white, ø 23 mm	100 pcs.	605 399

Reflect-Rhod

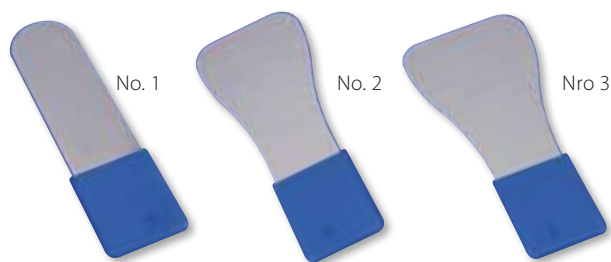

Rhodium-coated metal mouth mirror

- Ideal for distortion-free intra-oral photos
- Extensive rhodium coating on one side
- Sturdy, durable
- With detachable silicone handle
- Autoclavable in the provided fabric bag

Article description	REF
Set with 3 mirrors	355 480
No. 1 separately (40 x 163 mm)	355 481
No. 2 separately (69 x 163 mm)	355 482
No. 3 separately (79 x 163 mm)	355 483
Silicone handle separately	355 487

Parallelometer-Mirror



Mirror with parallel lines

- A proven specialty according to Prof. Böttger
- Fits all popular mirror handles (excluded from scope of delivery)
- Parallel check before imprint
- Autoclavable

Article description	REF
Parallelometer-Mirror	355 470

X-ray shield

- X-ray protection shield for the patient
- Safe by 0.5 mm lead lining
- In compliance with DIN 6813
- Approved by the German Institute of Radiation Safety, Munich, Germany
- Convenient for the patient – no heavy lead apron
- Easy exchange of handle



Protectoray wall mount

Article description	REF
Shield and handle	656 127
Wall holder, separately	656 128
Handle separately, exchangeable	656 701

Hygienic X-ray film holder

- Easy fixing of the film in the patient's mouth without the help of a finger (no irritation of mucosa, no gag reflex)
- Exact, as no bending of the film, no distortion of the picture
- For pictures of anterior teeth and molars, especially wisdom teeth
- Autoclavable, high-quality, unbreakable plastic
- In three colours: white, blue, grey

Article description	REF
Pack with 3 holders, assorted	656 300

Soft bite X-ray cushion

- Special foamed material with high adhesion
- Flap can be fixed to the film optimally and anywhere
- Ideal for bitewing, front, premolar and molar X-ray pictures

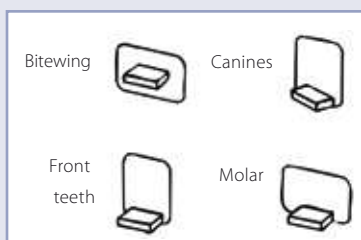

Article description	Content	REF
Emmenix-Flap	500 pcs.	656 303

Protective pouch for X-ray sensors

- Sensor gets inserted in the protective pouch and placed in the patient's mouth for radiography
- Protects the patient, the practice personnel and the sensor against humidity, saliva and blood
- High patient comfort by soft material
- Rounded edges, no risk of irritation
- Size: 36 x 105 mm

Article description	Content	REF
SLB-L, für CCD Sensor S/M	320 pcs.	656 232

Protectoray



Emmenix® Film Holder



Emmenix® Flap



Salibag



„No-ouch“ pouch



X-Ray Mesh



Adhesive scale for X-ray films

- Gets stuck onto the X-ray film prior to picture taking
- Also applicable for digital X-ray devices
- Scale allows an exact reproduction of proportions, particularly for pictures taken with a certain time lag between them



Article description	Content	REF
Test pack	5 pcs.	656 325
Pack	20 pcs.	656 326
Econo pack	50 pcs.	656 327

Röntgomarker



X-ray marking pen

- Waterproof, special white ink
- Very exact, hard and thin tip



Article description	REF
Röntgomarker	656 322



X-Ray Stain Remover

Liquid for stain removal

- Highly effective, long-approved
- Removes X-ray chemicals, iodine, rust, etc.

Article description	Content	REF
X-Ray Stain Remover	100 ml	656 220

Panascope



X-ray film viewer

- For any kind of X-ray picture
- Excellent illumination
- Can be installed as wall or table model
- In accordance with DIN 6856
- Available in two sizes

Article description	Size	REF
Panascope I (Maxi)	23 x 40 cm	656 130

Cold compress for pain relief

- Instantly applicable, cools for approx. 30 minutes
- Develops effective iciness within seconds
- Reduces swellings
- Eco-friendly, may serve as fertilizer after use

Article description	Content	REF
Cold-Bag compresses	10 pcs.	605 501

Cooling spray

- Approx. -50°C at the application canula (plastic)
- Orange flavour
- For vitality testing of devital teeth

Article description	Content	REF
Miracold Plus	200 ml	554 213

Cleansing solution

- For the removal of impression pastes, zinc oxide cements, dispersion adhesive (stickers, labels) from instruments
- Ideal for the cleaning of stainless steel
- Surfaces become shiny and are protected
- Fresh orange scent
- Available as liquid and spray

Article description	Content	REF
Orange Solvent liquid	250 ml	554 102
Orange Solvent spray	200 ml	554 201

Autoclavable nail brush

- Excellent for the cleaning of hands before and after treatment
- Extra long, hard-wearing bristles on the bottom
- Short bristles on the top

Article description	REF
Flexbrush	605 254

Cold-Bag



Miracold® Plus



Orange Solvent®



Flexbrush



Mira® Cleaning Wipes



Disinfection and cleaning wipes

- Disinfection of surfaces and inventory
- Bactericidal, fungicidal and virucidal (HIV/HBV/HCV)
- Fast, easy and secure
- Ideal for sensitive skin
- Free of alcohol, aldehyde, bleach and phenol
- Application time: 1 minute

Article description	Content	REF
Dispenser	115 pcs.	554 302

Praxipolish® Plus



Cleansing foam for dental practices

- Removes dirt, dirt rims, stains, etc. without effort
- For devices, plastic and wooden surfaces, etc.
- Supports bactericidal and disinfecting cleaning
- Tested by the neutral German "Institute for Hospital Hygiene and Infection Control" (IKI Gießen)

Article description	Content	REF
Praxipolish Plus	400 ml	554 208

Astro Clean®



Spray disinfection

- Particularly for disinfection of protective (uvex) glasses
- No damage to the anti-fog coating
- Generally usable for all surfaces in the medical field
- Bactericidal, fungicidal and virus-inactivating (HBV and HIV)

Article description	Content	REF
Astro Clean	250 ml	554 301

Miramask®



Disposable mask made of lightweight fleece material

- Hygienic and very good value for money



Article description	Content	REF
Miramask	100 pcs.	605 412

Pipette with two chambers

- For measuring out the exact dosage of drops or for thorough rinsing
- Front chamber = drops, rear chamber = rinsing
- Pipette end can be cut off for increased flow, e.g. for subgingival rinsing

Article description	Content	REF
Twin-Pipette	100 pcs.	605 352

Napkin holders

- Made of autoclavable rubber material with stainless steel clips

Article description	REF
Blue	605 240
Yellow	605 241
Violet	605 242
White	605 243

Disposable, hygienic napkin holder

- Easy to use: Remove protective foil and stick to paper napkin
- Stretch material made of soft silk like fiber for patient comfort
- Works with all bibs
- Easy handling and hygienic disposal
- Minimizes cross contamination
- No tangle dispenser

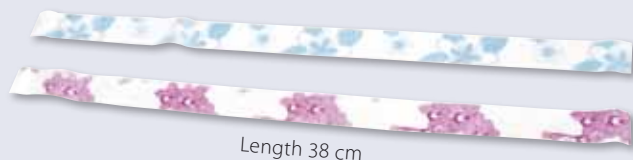

Article description	Content	REF
Blue	200 pcs.	605 249
Pink	200 pcs.	605 250

Container for disinfection

- Useful for small parts, such as burs, diamonds, etc.
- With opening in the lid
- With removable sieve for rinsing the content
- Both versions autoclavable
- Measures: Plastic: Total height approx. 12 cm, \varnothing approx. 8 cm
Metal: Total height approx. 5 cm, \varnothing approx. 9 cm

Article description	REF
BD-Steribox (plastic)	355 139
BD-Steribox (metal)	355 138

Twin-Pipette



Miraclip®



Fit-N-Fix



BD-Steribox



Miralay®



High-quality inlay adapter

- Instrument with single rubber inserts
- Autoclavable

When re-ordering the rubber inserts, please state whether you require push-in inserts (old version) or covering inserts (new version)

Article description	Content	REF
Miralay set	2 instruments + 4 bite blocks	355 210
Miralay replacement rubber inserts (push in)	2 pcs.	355 211
Miralay replacement rubber inserts (cover)	2 pcs.	355 213

Cotton-Clip



Cotton roll holder

- Holds cotton rolls securely in place for a dry working field
- Available in light plastic or solid, autoclavable stainless steel

Article description	Content	REF
Cotton-Clip I, plastic	100 pcs.	605 350
Cotton-Clip II, stainless steel	8 pcs.	605 351

Cottoroll



Cotton roll dispenser

- Hygienic, dry storage
- Quick and easy to take out – simply open the drawer
- Drawer refills automatically
- Convenient top-loading function
- Stable, nonslip

Article description	Content	REF
Cotton roll dispenser	1 pcs.	355 132

Skalpell-Ex / Pin-Clipper

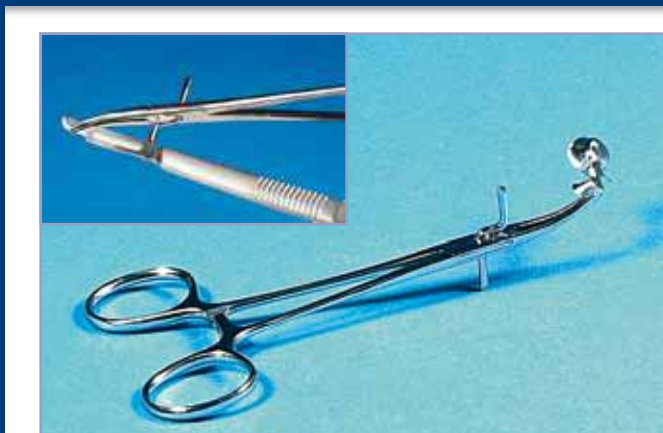

Special tweezers with dual function

For removal of scalpel blades

- Easy and safe removal of blade due to lever action
- We recommend the Miramatic-Box for the disposal of contaminated scalpels (see page 18)

Special tweezers with pin

- For holding crowns and bridges
- Both hands free due to pin
- Locking function

Article description	Content	REF
Skalpell-Ex / Pin-Clipper	1 pcs.	355 449

Sterile disposable surgical aspiration canula

- Extremely long (20 cm) for a free working field
- Fits all hoses with adapter
- Transparent plastic
- Individually sterile sealed
- Canula diameter: 2 mm

Set with 10 pieces incl. 1 adapter-set

Article description	Content	REF
Chirurgo-Suc I	10 pcs.	254 000

Surgical aspiration canula

- Ergonomic finger-grip handle, "non-stick indentation"
- Canula diameter 2 mm
- Fits to saliva ejector and hoses with a diameter of 11 mm and 16 mm
- 10 tips and handles each
- Autoclavable

Article description	Content	REF
Chiru-Tip white	10 pcs.	254 007

Surgical aspiration canula

- Made of high-quality, transparent, honey-coloured plastic
- Safe when getting into contact with activated electrodes (e.g. p. 55) or rotating instruments
- Autoclavable
- Fits to saliva ejector (6 mm) without adapter
- Ultra-light with approx. 3 g weight
- Incl. one Chiru-Cleaner (No. 23, REF 605 215)

Article description	Content	REF
Steri-Suc-Tube	10 pcs.	254 060

Cleaning brush for aspiration canulas

- Bendable, ideal for cleaning inside of canulas
- For all aspiration canulas with \varnothing 11 mm and 16 mm

Article description	Content	REF
Mirasuc Brush	6 pcs.	605 216

Cleaning brushes for surgical canulas

Article description	Content	REF
a) Chiru-Cleaner 23, 23 cm long	12 pcs.	605 215
b) Chiru-Cleaner 16, 16 cm long	6 pcs.	605 217
c) Chiru-Cleaner 12, cotton tip 12 cm long	5 pcs.	605 213

Chirurgo-Suc I



Chiru-Tip



Steri-Suc[®]-Tube



Mirasuc[®] Brush



Chiru-Cleaner[®]

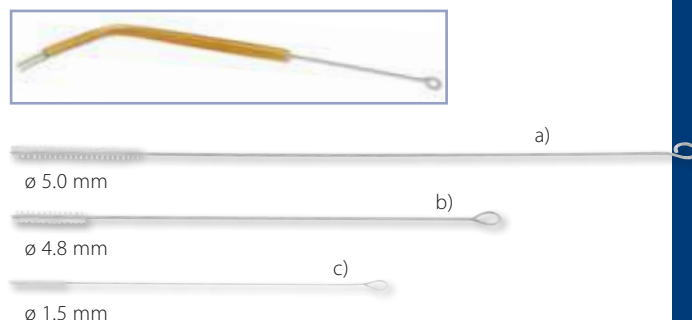

Mirasuc®-View



Aspiration canula with mirror developed by dentist Stephan Clasen, Münster, Germany

- Ideal aspiration and optimal view with one canula
- More light, better view, easier working
- Useful for all treatments with or without assistance
- Ergonomic operator posture easier to maintain
- ø 16 mm, length 12 cm, mirror size 4
- Mirror and canula autoclavable separately



Article description	Content	REF
Mirasuc-View	10 pcs.	254 035
Replacement mirror	10 pcs.	254 036

Mirasuc® 16



Autoclavable plastic aspiration canula

- Large square aspirator head, slightly rounded
- Ideal for aspiration with free view to working field at the same time
- ø 16 mm, length 12 cm
- Autoclavable

Set with 10 pieces

Article description	Content	REF
Blue	10 pcs.	254 018
Grey	10 pcs.	254 019
Assorted (5 x blue and green each)	10 pcs.	254 010

Mirasuc® Adapter



Extensions and connecting pieces for aspiration canulas

- Made of plastic, for all conventional suction units
- Extension from 6 mm to 16 mm (e) possible by combination of adapters (a) and (d)

Article description	REF
a) White, from 11 mm to 16 mm	254 130
b) Orange, from 11 mm to 16 mm	254 131
c) Grey, autoclavable, finger-grip handle extends the canula from 11 mm to 16 mm	254 133
d) White, from 6 mm (salvia ejector) to 11 mm	254 132
e) Combination of adapters a) and d), from 6 to 16 mm	
f) Grey, adapter reduction from 16 mm to 11 mm	254 105

Autoclavable plastic aspiration canula

- Very convenient for the patient, with round head
- Also ideal in paediatric dentistry
- ø 11 mm, length 10.5 cm
- Autoclavable

Set with 10 pieces including 1 adapter (from ø 11 mm to 16 mm)

Article description	Content	REF
Green	10 pcs.	254 024
Blue	10 pcs.	254 025
Grey	10 pcs.	254 026
Assorted (4 x grey, 3 x blue and green each)	10 pcs.	254 029

Disposable plastic aspiration canula

- Canula with round head
- ø 11 mm, length 10 cm

Box with 50 pieces including 1 adapter (from ø 11 mm to 16 mm)

Article description	Content	REF
White	50 pcs.	254 022
Orange	50 pcs.	254 023

Longer disposable plastic aspiration canula

- With square head
- ø 11 mm, length 14 cm

Box with 50 pieces

Article description	Content	REF
White	50 pcs.	254 020
Orange	50 pcs.	254 021

Aspiration canula with pelotte

- Optimal aspiration when using (sand-) blaster units
- Removable pelotte funnel made of soft silicon
- Easy cleaning and autoclavable
- Canula ø 16 mm, length ca. 10 cm, Pelotte ø 24 mm and length 34 mm

Article description	Content	REF
Mirasuc Absorbo	3 pcs.	254 052
f) Grey, adapter reduction from 16 mm to 11 mm*		254 105

*eventually use with adapter f) (see page 44)

Pelotte Plus



Pelotte-Aspirator



Mirasucto®



Mirasuc® Absorbo



Mira-2-Ton® Lösung



Plaque test

- Older plaque is revealed in blue, newer plaque in pink
- Proven in the dental practice for years
- Patient-friendly, motivating
- Erythrosine- and gluten-free
- Discolourations can be removed by brushing teeth

Article description	Content	REF
Mira-2-Ton solution	60 ml	605 655

For further Mira-2-Ton products see page 66.

Mira-Clin P®



Approved prophylaxis paste with coarse granulation

- For professional tooth cleaning in the dental surgery
- Low abrasion with optimal cleaning effect
- Pleasant fruit taste
- Free of fluoride and menthol

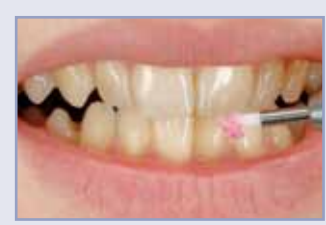

Article description	Content	REF
Mira-Clin P	250 g	605 656
Box with 200 dishes, 2 g each and stainless steel finger ring II		605 658
Finger ring II separately		605 444

Mira-Clin hap



Similar image

Prophy Paste with hydroxylapatite

- For professional tooth cleaning and polishing
- Cleaning particles change size from coarse (cleaning) to fine (polishing)
- Builds up biomimetic enamel due hydroxyapatite
- With toothfriendly Xylitol
- Pleasant mint taste
- Free of gluten and phthalate

Article description	Content	REF
Mira-Clin hap	75 ml	605 654

Mira Clean®



Mouth rinsing tablets for dissolving

- Refreshing, slightly antiseptic, cooling
- The little additional service for the patient
- Also ideal for prophylaxis with air scalers
- Pastilles dissolve completely within max. three minutes
- In two pleasant flavours: mint and thymol

Article description	Content	REF
Mint (green)	1,000 pastilles	605 504
Thymol (pink)	1,000 pastilles	605 505

Rubber cups for prophylaxis

- For single use
- Latex-free
- Available in two grades of hardness

Article description	Content	REF
Screw on regular blue	50 pcs.	605 832
Screw on soft green	50 pcs.	605 833
Snap on regular blue	50 pcs.	605 830
Snap on soft green	50 pcs.	605 831
Contra Angle regular blue	50 pcs.	605 834
Contra Angle soft green	50 pcs.	605 835

Disposable tips with rubber cups

- Latex-free
- In two hardnesses
- Only for hand pieces

Article description	Content	REF
Regular violet	100 pcs.	605 836
Soft green	100 pcs.	605 837

For optional hand piece HST R see page 87.

Stainless steel button mandrell for counter-angle

(delivery without Prophy-Cups)

Article description	REF
Prophy-Mandrell	605 672

Micro spiral brush with stainless steel shaft

- For cleaning and polishing hard-to-reach areas, e.g. interdental spaces, etc.

Rotoprox Mini

Article description	Content	REF
Straight (20 mm long)	50 pcs.	605 792
Pointed (21 mm long)	50 pcs.	605 793

Rotoprox

Article description	Content	REF
Rotoprox for CA \varnothing 2.0 mm X-fine/straight 27 mm long	10 pcs.	605 719
Rotoprox for CA \varnothing 2.2 – 2.5 mm Fine/conical 27 mm long	10 pcs.	605 721

Prophy-Cup®



Prophy-Angles



Prophy-Mandrell



Rotoprox®



Miradont®-Gel



Micro nutrient gel for oral medical provision

- Oral medical provision with micro nutrients
- Beneficial healthy climate due to physical changes of the oral flora
- Ideal after surgery or periodontal treatments, in aphthae, lichen, flord herpes lesions and denture pressure spots
- Accelerates tissue regeneration
- Contains no alcohol, saccharin, menthol or preservatives
- Neutral taste

Article description	Content	REF
Miradont-Gel	15 ml	155 000

For Dentosmin P see page 33.

Mirafluor®-Tray

With level indicator



Application tray for fluoride gel

- Made of light, flexible plastic
- With level indicator
- Double tray for simultaneous treatment of maxilla and mandible
- In yellow colour contrasting any gel

Article description	Content	REF
Small	50 pcs.	605 620
Medium	50 pcs.	605 621
Large	50 pcs.	605 622

mirafluor®-gel



Fluoride gel for intensive caries prophylaxis

- Increases the acid resistance of the enamel
- Decreases plaque formation
- Accelerates the remineralisation
- mirafluor-gel with 1.23 % fluoride
- mirafluor-k-gel with 0.6 % fluoride is particularly suited for children aged 6 or older

Article description	Content	REF
mirafluor-gel, mint	250 ml	605 800
mirafluor-gel, strawberry	250 ml	605 801
mirafluor-k-gel, cola	250 ml	605 802
mirafluor-k-gel, strawberry	250 ml	605 803

mirafluor®-k-gel (for children)

Mirafluorid®



Mirabrush brush see page 11

Fluoride varnish on emulsion basis with 0.15 % fluoride

- Free of solvents
- For precise application, can also be applied in a humid environment
- Fluoride concentration clearly lower than in comparable varnishes: 0.15 % fluoride
- Aqueous polymer layer allows fluorides to diffuse and is decomposed by the saliva without causing any problems

Article description	REF
5 ml bottle and 20 Mirabrush brushes	605 810
Mirabrush brush (blue/flat), 100 pcs.	605 461
Mirabrush brush (yellow/pointed), 100 pcs.	605 460

Oral health rapid test for paradontitis early detection and risk assumption

- Preventive: Indicates acute risk of paradontitis before conventional diagnostics
- Painless: gentle, diagnosis after only 10 minutes
- Delegable: screening, monitoring and follow-up by dentals assistance
- Successful: for sensitisation, motivation and gaining of patients
- Interdisciplinary: to avoid secondary damage for patience with cardio-vascular symptoms, diabetics, rheumatic patients, women with desire to have children or heavy smokers
- Parodontal atrophy is detected by measuring the enzyme aMMP-8 (active matrix-metalloproteases)

Article description	Content	REF
PerioMarker	2 separately tests	605 852

Scientific studies on request.

ImplantMarker-Rapid test of implant health for early detection of periodontal bone loss- and tissue atrophy processes

- Prognostic: Regular implant screening detects PI risks long before conventional diagnostics
- Preventive: Helps avoiding periodontal bone loss by early begin of therapy
- Painless: Atraumatic sample taking at the implant. Diagnosis after only 10 minutes
- Successful: For sensitisation, motivation and patient retention
- Delegable: Economic optimisation of recalls, screening by dentist or dental assistance
- Early detection of concealed tissue loss by detecting the active matrix collagenase (aMMP-8) at the dental implant

Article description	Content	REF
ImplantMarker	4 separately tests	152 052

1 Collect sample

Place the collection strip for 30 seconds as deeply as possible in the sulcus; the blue section must be pointing away from the tooth

2 Pivot

Pivot the fluid by turning the vial upside down 5 times (do not shake!)

3 Wait for result

Remove the DIPSTICK test from the elution fluid and place it on a level surface

4 Read results after 5 minutes

Read results after 5 minutes; after more than 7 minutes the results will become invalid and should be disregarded. Note: even a weak test line represents an elevated level of aMMP-8!

PerioMarker®

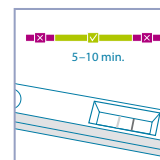
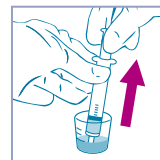
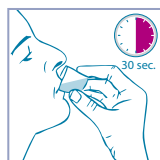

ImplantMarker

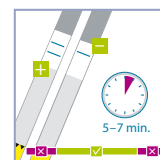
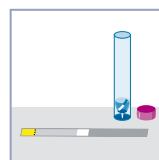
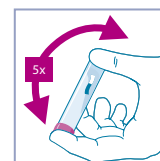
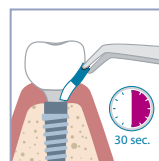

Mc Tooth® Mirror



Molar-shaped pop-up mirror

- For prophylaxis in children and adults
- Measure ca. 17 x 14 cm

Article description	REF
McTooth Mirror	707 094

Mira-Duo®



Double-sided patient mirror

- Front 1:1, back twofold magnification
- ø 13 cm
- May be used as hand or table mirror
- Ideal for control – especially in prophylaxis

Article description	REF
Mira-Duo	605 682

Toothbrushing Model



Enlarged demonstration model

- For demonstration of the correct brushing technique
- With oversized toothbrush
- Ideal for motivation of children



Article description	REF
Model incl. super brush	355 636
Super brush separately	355 637

Dento Box® I + II



Dento Box II: Height 4 cm



Dento Box I: Height 2.5 cm



Solid transport and storage box

- For prosthesis, orthodontic works, etc.
- Impact-proof, safe snap lock and small ventilation holes
- Ideal advertising medium with your name and address (from 500 pcs.)

**This article can be delivered with your advertising imprint.
Please ask for a quotation.**

Article description	Content	REF
Dento Box I, white	12 pcs.	355 148
Dento Box II, white	10 pcs.	355 141
Dento Box II, blue	10 pcs.	355 142
Dento Box II, pink	10 pcs.	355 143

For Dento Box with hang cord see page 68.

High-quality transparent demonstration model with tooth diseases

- Demonstration of various tooth defects and courses of carious defects
- Teeth not removable
- Scale 1:1

Model De Luxe

- De Luxe model featuring malocclusion of lower wisdom teeth
- Several examples of inflammatory root processes
- Illustration of an implant work with build-up

Article description	REF
Study Model Transparent De Luxe	355 642
Study Model Transparent Plus	355 640

High-quality transparent demonstration model

- All 32 teeth can be removed from the alveole
- Well visible root anatomy
- Made of transparent, solid plastic
- Scale 1:1

Article description	REF
Study Model Transparent	355 641

Demonstration model child

- Very clear illustration of deciduous and permanent teeth
- Maxilla and mandible with ten deciduous teeth
- With broken deciduous front tooth with root disease
- Scale 1:1

Article description	REF
Study Model Transparent Child	355 643

Educational model with prosthetic restorations

- Study model for demonstration of In-/Onlay and implant cases
- Complete acrylic display with 11 removable dental appliance
- Scale 1:1

Article description	REF
Study Model Demo Implant C+B	355 638
Replacement restorations (11 pcs)	355 639

Study Model Transparent Plus and De Luxe



Study Model Transparent



Study Model Child

Study Model Demo Implant C+B



Putzi-Pets



Putzi-Buddys



Miratoi® No. 3



Miratoi® No. 4



Hand puppets with denture

- The ideal aid to motivate children
- For explanation of appropriate dental care
- Special effect: With the small water bottle, the puppets turn into water pistols
- Dimensions: W x H x D: approx. 17 cm x 28 cm x 15 cm

Article description	REF
Putzi Croc	707 045
Putzi Dino	707 046
Putzi Cow	707 047
Putzi Horse	707 048
Putzi Dragon	707 092
Putzi Tiger	707 093

Big hand puppets with denture

- Dimensions: W x H x D: approx. 25 cm x 38 cm x 18 cm



Article description	REF
Cow Berta	707 081
Lion Leo	707 082
Teddy Bear	707 083
Horse Jimmy	707 084

Farm Set

- Various farm animals



Article description	Content	REF
Miratoi No. 3, assorted	100 pcs.	605 692

Zoo Set

- Various zoo animals



Article description	Content	REF
Miratoi No. 4, assorted	100 pcs.	605 693

Mixed Assortment

- Cars, boats, combs, etc.



Article description	Content	REF
Miratoi No. 1, assorted	150 pcs.	605 690

Finger rings

- Lovely finger rings in various sizes



Article description	Content	REF
Miratoi No. 6, assorted	100 pcs.	605 694

Watches

- Puzzle in the shape of watches in various colours



Article description	Content	REF
Miratoi No. 7, assorted	84 pcs.	605 695

Bouncy balls

- Funny bouncy balls in various colours
- ø 2.5 cm



Article description	Content	REF
Miratoi No. 8, assorted	100 pcs.	605 696

Miniature cars and boats

- Miniature cars and boats in different colours



Article description	Content	REF
Miratoi No. 10, assorted	100 pcs.	605 698

Miratoi® No. 1



Miratoi® No. 6



Miratoi® No. 7



Miratoi® No. 8



Miratoi® No. 10



Miratoi® No. 12



Medal set

- Special award as motivation for brave young patients
- Stamped medal with ribbon
- Made of plastic

Certificates in different languages available on request!

D - GB - F - E - IT - NL - HR - SRB - MK - P



Package with 50 pcs. and 50 certificates

Article description	Content	REF
Miratoi No. 12	50 pcs.	605 706

Miratoi® No. 13



Treasure chests

- Ideal for the safekeeping of deciduous teeth



Article description	Content	REF
Miratoi No. 13, assorted	100 pcs.	605 699

Miratoi® No. 15



Mini Ponies

- For combing and cuddling
- In five different colours



Article description	Content	REF
Miratoi No. 15	50 pcs.	605 701

Miratoi® No. 17



Fingerboards

- Ultimate fingerboards in five cool designs



Article description	Content	REF
Miratoi No. 17	50 pcs.	605 707

Tooth shaped coin bank

- Solid ceramic-like material
- Cushioned, non-slip feet
- Translucent cap at the bottom for coin removal
- Dimensions approx. 13 cm x 13 cm x 13 cm

Article description	REF
Tooth Coin Bank	707 105

Effective relaxation aid

- By squeezing the tooth, the patient gets pleasantly distracted
- Ideal for stress relaxation or as a gift
- Dimensions: 64 x 54 x 38.5 mm, weight: 42 g
- Material: polyurethane

Article description	REF
Anti Stress Tooth	707 002

Cream for hand care

- Free of mineral oils and silicones
- Free of artificial colours
- Free of animal-derived ingredients
- Free of synthetic perfumes

ALOE VERA for normal and sensitive skin

- Easily absorbed by the skin

OLIVE-BUTTER for demanding and dry skin

- Pleasant for people suffering from skin diseases, such as neurodermatitis
- Easily absorbed by the skin

SHEA-BUTTER for demanding and dry skin

- Rich and easily absorbed by the skin

Value pack- low price

Article description	Content	REF
Aloe Vera cream	500 ml	660 302
Oliven Butter cream	500 ml	660 300
Shea Butter cream	500 ml	660 301

For natural soft lips

- Conditions and protects
- With nuturing Shea Butter, protecting Jojoba Oil and regenerating Aloe Vera

Article description	REF
Plantana Lip-Balm, jar 5 g	660 318
Plantana Lip-Balm display, 20 jars	660 319

Tooth Coin Bank



Anti Stress Tooth



Plantana®



Plantana® Lip Balm



5 g

From the practice for the practice



miradent catalog

miradent SOS Dentobox®



Dear Dental Practitioners

Our miradent brochure contains detailed information about our oral health care products. Our prophylaxis line has been developed together with dentists to fit your patients needs. In many countries they are also available in pharmacies.

When ordering miradent prophylaxis products, please indicate your desired language in addition to the article number, as we offer our home care products in various languages.

Visit us at www.miradent.de

Tooth rescue box after tooth accidents

- Special nutrient solution prolongs the chances to replant avulsed teeth and fragments for up to 48 hours
- Cells of the desmodontium remain intact until replantation
- Safe and verifiably best storage for preservation of one's tooth



Article description	Content	REF
miradent SOS Dentobox		631 040
miradent SOS Dentobox Display	6 pcs.	635 115

Xylitol Powder



Xylitol – a 100 % natural and healthy sugar substitute

- For sweetening of cold and hot drinks, fruit, cereals or for baking
- Ideal for a balanced and healthy diet
- Same sweetening effect as sugar
- Purely natural product, gluten-free and not genetically modified
- 40 % less calories than saccharine



friendly for teeth

Excessive consumption may produce laxative effects.

Article description	Content	REF
Xylitol powder	350 g	630 119
Xylitol powder	100 x 4 g sachets	630 120
Xylitol powder	5 x 350 g	635 080

Dental care chewing gum

- Sweetened with 100% xylitol
- Free of aspartame, sorbitol, lactose and gluten
- Helps against bad breath
- Spearmint and peppermint flavours contain menthol
- Promotional HV display made of acrylic available on request

Reclosable tube with 30 gums / 30 g

Article description	Content	REF
Spearmint		630 079
Peppermint		630 080
Cinnamon		630 081
Fresh Fruit		630 082
Cranberry		630 090
Green Tea		630 091
Display, assorted	6 x 12 tubes.	635 208

Dispenser box with 200 packs of 2 dragees each

Article description	REF
Dispenser box chewing gums, assorted	635 069

Dental care chewing gum especially for children

- Sweetened with 100% xylitol
- Free of aspartame, sorbitol, lactose and gluten
- Child friendly design and taste
- Caries preventive, plaque inhibiting and re-mineralising

Article description	REF
Apple, 30 Dragées / 30 g	630 192
Display, 12 Spcs. à 30 Dragées	635 203

Tooth friendly drops sweets with 100% natural Xylitol – sugar free

- Anti caries and anti plaque effect, re-mineralising
- Stimulates saliva production (ideal in xerostomia)
- Free of aspartame, sorbitol, lactose and gluten
- Suitable for diabetics
- Cool and refreshing taste

Article description	Content	REF
Xylitol Drops melon	60 g / 26 pcs.	630 170
Xylitol Drops cherry	60 g / 26 pcs.	630 171
Xylitol Drops mint	60 g / 26 pcs.	630 172

Dispenser box with 100 drops

Article description	REF
Dispenser box, assorted	635 183

Xylitol Chewing Gum



For more information and list of ingredients, see page 68

Xylitol Chewing Gum for Kids



For more information and list of ingredients, see page 68

Xylitol Drops



Carebrush® white



Toothbrush with „whitening effect“

- Brush head with special rubber lamellas cleans thoroughly, while also having a natural tooth whitening effect
- Spiral-shaped bristles at the front of the brush head optimise access to difficult-to-reach areas
- Criss-cross bristles support thorough cleaning of interdental spaces
- Anatomic „anti-slip“ handle

Article description	REF
Carebrush white, green	630 190
Carebrush white, pink	630 191
Carebrush white Display, 8 pcs. each	635 205

Carebrush® supersoft



Toothbrush with silky-soft micro bristles

- Silky-soft bristles for hypersensitive teeth necks and irritated gums (e.g. in periodontitis) and for dental care following prophylaxis treatments
- Gentle and thorough cleaning with low enamel abrasion
- Tongue scraper at back of the brush head
- Anti-slip handle

Article description	REF
Carebrush supersoft	630 195

Happy Morning® De Luxe



Toothbrush with good cost-effectiveness

- Rounded bristles and angled handle
- Bristle size medium
- Separately packed

Article description	Content	REF
Happy Morning De Luxe	50 pcs.	605 443

Happy Morning® Travel Kit



Dental care travel kit companion

- Toothbrush and 3 g tube with fresh mint toothpaste
- Toothbrush and tube hygienically blister-packed as set
- Toothbrushes in five colours, assorted, 5 x 10 pcs.

Article description	Content	REF
Happy Morning Travel Kit	50 pcs.	605 410

Sonic toothbrush with tongue scraper

- 30,000 micro vibrations per minute
- Tongue scraper at back of brush head
- Replaceable battery (AAA) included
- Weight: 60 g
- Replacement brush-set includes 2 brush heads + 4 colour-coded rings

Article description	REF
Prosonic micro 2, hand piece with brush head and battery	630 182
Prosonic micro 2, replacement set with 2 brush heads	630 183
Prosonic micro 2, Display with 24 toothbrushes and 6 replacement sets	635 200

Prosonic micro 2



Disposable toothbrush

- Ideal for brushing teeth in the dental practice before treatment, on short trips, etc.
- Hygienically and separately packed



Article description	Content	REF
Impregnated with toothpaste	100 pcs.	605 401
Without toothpaste	100 pcs.	605 403

Happy Morning®

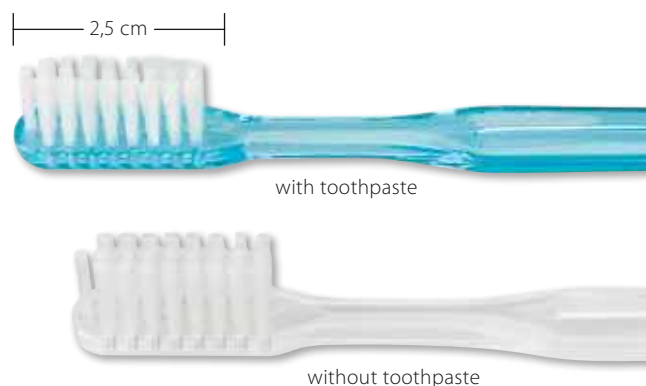

Disposable toothbrush with xylitol

- Bristles are impregnated with xylitol toothpaste
- Fresh flavour
- Short head design (2.5 cm)
- Hygienically and separately packed
- Ideal when traveling, in between meals and as toothbrush for guests
- Xylitol has an anti-cariogenous effect, decreases plaque- and acid-forming bacteria



After meals



When travelling



In the office



Prior the date

Article description	Content	REF
Happy Morning Xylitol	50 pcs.	605 496

Happy Morning® Xylitol



mirawhite® oxygen



Effective whitening for sensitive teeth

- Hygienic pen application
- Tooth whitening without peroxide with active oxygen
- Soft to the enamel and the gingiva
- Tooth whitening by up to five shades
- Application period 7 – 14 days, twice per day



Article description	Content	REF
Mirawhite oxygen	1.8 ml	631 097
Mirawhite oxygen Display	8 packages	635 194

For office bleaching, we recommend mirawhite laser bleaching, see page 73.

paroguard®



Dosing cap
For easy-to-measure doses of the mouth rinsing solution

paroguard® 5 l



Mouth rinsing solution

- Remineralizing due to fluoride (250 ppm)
- Ideal for patients with limited oral hygiene
- Astringent due to hamamelis
- Anti-cariogenous due to xylitol
- Alcohol-free

Article description	Content	REF
paroguard	200 ml	630 087

Size with advantage 5 liters

- Optionally available with dosing pump (1 push = 10 ml)

Article description	Content	REF
paroguard (without pump)	5,000 ml	630 127
Pump separately		630 138

mirafluor® chx



Mouth rinsing solution with chx 0.06 %

- For daily use, incl. dosing cap
- Remineralizing due to fluoride (250 ppm)
- Astringent due to hamamelis
- Anti-cariogenous by xylitol
- Alcohol-free
- Support of daily mouth care due to chlorhexidine gluconate (0.06 %)

Article description	Content	REF
mirafluor chx 0.06 %	100 ml	630 085
mirafluor chx 0.06 %	500 ml	630 086

Intensive cleaning for shiny white teeth

- Immediate illuminating effect
- Restores natural tooth whiteness
- Innovative multiple-effectiveness
- Xylitol and sodium fluoride (fluoride 1,450 ppm) prevent caries

Article description	Content	REF
Mirawhite gelée	100 ml	630 123
Mirawhite gelée Display	9 packages	635 097_GB

Mirawhite® gelée



Intensive care for the preservation of sensitive teeth

- Sealing of open tubuli
- Builds up biomimetic enamel due to 30 % hydroxyapatite
- Calms the tooth nerve due to potassium ions
- Daily treatment to protect teeth from painful stimuli
- Contains fluoride and xylitol to prevent decay and tooth neck decay
- Mild and fresh taste
- RDA-value: 20
- Sodium fluoride (fluoride 1,450 ppm)

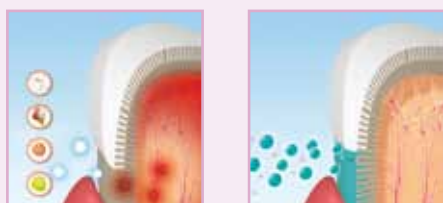

Article description	Content	REF
mirasensitive hap+	50 ml	630 169
mirasensitive hap+ Display	8 pcs.	635 191

mirasensitive hap+®



High-quality amino fluoride toothpaste

- RDA value 17
- Fine abrasive silica particles
- Mild mint flavour
- Amino fluoride (fluoride 1,250 ppm)

Article description	Content	REF
mirafleur c	100 ml	630 083
mirafleur c Display	8 packages	635 195GB

Mirafleur® C



Mirafloss®



Dental floss/tape

- For specially thorough cleaning of interdental spaces
- Extremely tear-proof, does not fray
- Tape: not waxed, but consisting of PTFE, glides perfectly through even the narrowest interdental spaces

Article description	Content	REF
Tape	20 m	630 022
chx-Tape	20 m	630 078
Tape unwaxed	20 m	630 077

Mirafloss® Implant chx



Floss fibres from the roll

- 50 floss fibres (15 cm each), rolled up in a handy dispenser
- Stiff ends facilitate threading
- Fleecy centre part saturated with 0.2 % chx solution
- Ideal for the cleaning of implants and bridges
- Available in two thicknesses: fine (ø 1.5 mm) and medium (ø 2.2 mm)



Article description	REF
Fine (pink)	630 134
Medium (turquoise)	630 135

Mirafloss® Big



Wall-mountable dispensing box

- Ideal for professional use in practice
- One-handed operation using sharp metal edge
- Refillable

Article description	Content	REF
Mirafloss Big (white, waxed / black, waxed, mint)	2 x 200 m	605 735
Refills: black, mint	200 m	605 737
Refills: white, waxed	200 m	605 736
Refills: white, unwaxed	200 m	605 738

Mirafloss® interspace



Cut mechanism
For comfortable cutting of remaining floss

Dental floss holder with fluoridated floss

- Patented dental floss holder, clinically tested
- Easy use of floss even in hard-to-reach interdental spaces
- Fluoridated PTFE floss glides particularly well
- Economic in use
- Refillable
- Deposit function: hygienic depot in the handle for keeping refillable dental floss

Article description	Content	REF
Red	1 pcs.	630 054
Refill, 2 x 10 m	2 rolls	630 055

Convenient combination of dental floss and toothpick

- 30 pcs.: handy resealable box, 100 pcs.: separately blister-packed

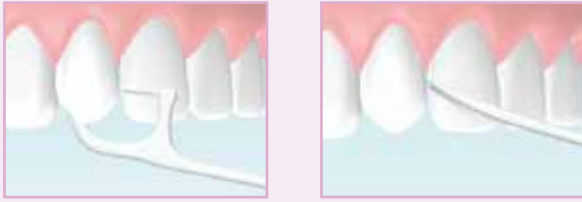

Article description	Content	REF
Zahnpick, resealable box	30 pcs.	630 039
Zahnpick, individually wrapped	100 pcs.	605 637

Interdental brush in pocket size

- Adjustable angles for flexible use
- Antibacterial effect due to chx impregnation of bristles (approx. 0.2 %)
- Coated special wire with ultra-fine bristles
- Hygienic cap also to be used as handle extension



Click-in display

Article description	Content	REF
Pink	6 pcs.	630 092
Yellow	6 pcs.	630 093
White	6 pcs.	630 094
Green	6 pcs.	630 095
Bordeaux	6 pcs.	630 097
Orange	6 pcs.	630 096
Assorted	6 pcs.	630 098
Click-In Display with 9 pcs. assorted		635 166

Zahnpick®



Resealable box



I-Prox® chx



Hygienic cap

Design	Insert Cylinder	Cleaning Cylinder
xx-fine	Ø 0.5 mm	Ø 1.8 mm
x-fine	Ø 0.6 mm	Ø 1.9 mm
fine	Ø 0.7 mm	Ø 2.5 mm
medium	Ø 0.8 mm	Ø 3.5 mm
large	Ø 0.8 mm	Ø 5.0 mm
conical	Ø 0.8 mm	Ø 2.5 – 5.0 mm



Pic-Brush® Set



Pic-Brush® Intro Kit

Interdental brush holder with one brush

- Connector system with conical neck for a safe fit
- Ergonomically shaped handle with 120° angle
- Flexible high-quality brushes, coated special wire, ultra-fine bristles
- Protection against injuries due to elaborate loop technique of wire end
- Holder end with storage compartment and clip-on function
- Also for cleaning of brackets, bridges and dentures

Article description	Colour	REF
Holder with 1 brush	blue transparent	631 002
Holder with 1 brush	pink transparent	631 003
Holder with 1 brush	dark blue	630 001
Click-In Display with 9 pcs.	assorted	635 167



Storage compartment



Interdental brush holder with four brushes in four thicknesses

Article description	Colour	REF
Holder with 4 brushes	blue transparent	630 005
Holder with 4 brushes	pink transparent	630 006
Holder with 4 brushes	yellow	605 728
Holder with 4 brushes	dark blue	6301 004

Pic-Brush® Replacement Brushes

Design

pink xx-fine		ø 0.45 mm		ø 1.6 mm
yellow x-fine		ø 0.5 mm		ø 1.8 mm
white fine		ø 0.6 mm		ø 2.0 mm
green medium		ø 0.8 mm		ø 2.2 mm
blue large		ø 0.8 mm		ø 3.0 mm
bordeaux x-large		ø 0.8 mm		ø 6.5 mm
orange conical		ø 0.5 mm		ø 2.5 - 5.0 mm

In hygienic storage box or as practice refills



Article description	6 pcs.	12 pcs.	Refills 25 pcs. bag
Pink	631 013	605 748	607 060
Yellow	631 014	605 713	607 061
White	631 015	605 722	607 062
Green	631 016	605 631	607 063
Blue	631 017	605 632	607 064
Bordeaux	631 050	605 789	607 065
Orange	631 018	605 711	607 066
Assorted		605 633	

Pointed brush for precise use

- Efficient cleaning of gingival border and gingival pockets with tapered bristle tuft
- Ideal for the cleaning of orthodontic appliances, implants and interdental spaces
- Optimal application of preparations
- Finger-grip handle (14 cm) with two click-on angles (60° and 120°)
- Holder end with storage compartment for brushes



Gingival pocket Implants Brackets

Article description	REF
Holder blue transparent incl. 4 tips	630 032
Holder pink transparent incl. 4 tips	631 033
Replacement brushes, 4 pcs.	631 034
Click-in Display with 9 pcs., assorted	635 168

Interdental care set

- For efficient cleaning of sulcus, interdental spaces and bridges
- Finger-grip handle allows safe and precise use
- Holder end of sulcus brush with storage compartment for replacement brushes
- Anti-fog coated mouth mirror for immediate self control
- I-Prox C for specially persistent adhesences

Set includes:
 miradent mouth mirror, I-Prox C (double-ended toothscaler/cleaner)
 I-Prox P sulcus brush

Article description	REF
Set of 3 blue transparent	630 160
Click-In Display with 9 pcs.	635 171

Disposable anti-fog mouth mirror from plastic

- Flat angulated mirror head reaches all regions in the mouth
- Novel anti-fog coating
- Ergonomic finger form handle
- For domestic tooth control
- Diameter 23 mm / no. 5

Article description	REF
Blue transparent	630 065
Pink transparent	630 066

For mouth mirrors in practical economy pack (50 pieces), see page 36.

I-Prox P®

Switch-function

a push connection allows two different attachments angles for various possible applications

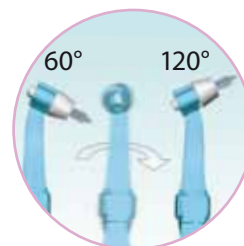

I-Prox® Care Set



miradent® Mouth Mirror



Mira-2-Ton® Solution



Plaque test

- Chewable tablet or solution
- Older plaque is revealed in blue, newer plaque in pink
- Proven in the dental practice for years
- Patient-friendly, motivating
- Erythrosine- and gluten-free
- Discolourations can be removed by brushing teeth
- Easily to halve – one tablet sufficient for 2 applications

Article description	Content	REF
Mira-2-Ton solution	60 ml	605 655
Mira-2-Ton solution	10 ml	605 659
Mira-2-Ton solution, Display	10+2 x 10 ml	605 660

Mira-2-Ton® Tablets



Article description	Content/Colour	REF
Mira-2-Ton tablets	6 pcs.	630 027
Mira-2-Ton tablets	50 pcs. (5 x 10)	605 765
Mira-2-Ton tablets	250 pcs. (lose)	605 768
Mira-2-Ton tablets, Display	16 x 6 pcs.	635 184
Mouth mirror (ø 23 mm) separately	blue transp.	630 065
Mouth mirror (ø 23 mm) separately	pink transp.	630 066

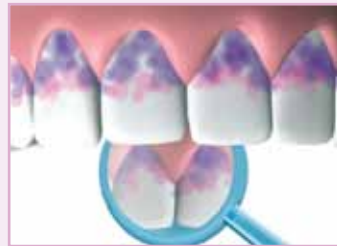

halitosis spray



Oral care spray for immediate fresh breath

- Eliminates mouth odour (halitosis)
- Dental care properties due to added xylitol (10%)
- Alcohol-free



Article description	Content	REF
halitosis spray	15 ml spray can	630 180
halitosis spray Display	12 spray cans	AK-1203GB



Tongue cleaner

- Dual function in one instrument:
 - Bristle field with short, rounded bristles lifts off tongue coatings
 - Tongue scraper removes the loosened coatings subsequently
- Angled, flat arched top reduces gag reflex
- Handy finger-grip handle with protective cap

Article description	Content	REF
Blue transparent		630 029
Pink transparent		630 030
Blue		605 778
Click-In Display, assorted	9 pcs.	635 170

Tongue cleaning gel with a gentle and nurturing cleaning effect

- Removes tongue coatings gently
- Nurtures with camomile, sage and calendula
- Long-lasting feeling of freshness
- Alcohol-free

Article description	Content	REF
Tong-Clin Gel	50 ml	630 059
Tong-Clin Set	1 tongue cleaner + 50 ml Gel	630 060
Tong-Clin Fresh	1 tongue cleaner + 15 ml Gel	630 179
Tong-Clin Fresh Display	14 pcs.	635198

Prosthesis brush

- With two brush heads: large brush field for cleansing of outer prosthesis surfaces and smaller brush field for the hard-to-reach inner sides
- Ergonomically shaped finger form-grip handle

Article description	Content	REF
Blue transparent		631 024
Pink transparent		631 025
Dark blue		605 413
Click-In Display, assorted	9 pcs.	635 169

Waterproof, lockable prosthesis box

- For storage and cleaning of prosthesis
- Waterproof due to special locking
- Holds 2 prostheses and approx. 80 ml of liquid
- Also suitable for storage of removable braces
- Box contains double-sided cleaning brush, white bristles for basic surfaces, black bristles for prostheses indentations
- Brush compartment also for cleaning tablets
- With mirror in the lid

Article description	REF
Box incl. brush	605 900
Brush separately	605 901

Tong-Clin® De Luxe



Tong-Clin® Gel



Protho Brush® De Luxe



Protho Box



Dimensions (WxHxD):
11.5 x 4.5 x 8.5 cm

Infant-O-Brush®



Learner's toothbrush integrated in a teething ring

- Teaches regular dental care in a playful way
- Teething ring with extra soft bristle field
- Nubs enhance dentition
- Oval shape eliminates risk of swallowing and injury
- For infants from 3 months of age

Article description	REF
Red	630 026
Yellow	605 617

miradent® Hourglass



Child-appropriate hourglass as timer for tooth brushing

- Ideal for observing the recommended minimum brushing time
- Running time: 2 minutes
- Attachable to any smooth surfaces due to suction cup



Article description	REF
miradent Hourglass	630 068

Dento Box® I



Solid transport and storage box

- For prosthesis, orthodontic works, etc.
- Impact-proof, safe snap lock and small ventilation holes
- With trendy hang cord

Article description	Content	REF
Dento Box I, white	1 pcs.	630 162
Dento Box I, blue	1 pcs.	630 161
Dento Box I, pink	1 pcs.	630 163

For Dento Box without hang cord see page 50.

Xylitol Chewing Gum



Product description see page 57

Spearmint, Peppermint, Cinnamon - Ingredients: sweetener: xylite, gum base, flavour, humectant: glycerin, thickening agent: gum arabic, emulsifier: **soy lecithin**, colouring agent: titanium dioxide, coating agent: carnauba wax.

Fresh Fruit, Cranberry - Ingredients: sweetener: xylite, gum base, flavour, humectant: glycerin, thickening agent: gum arabic, acidity regulator: malic acid, emulsifier: **soy lecithin**, colouring agent: titanium dioxide, coating agent: carnauba wax.

Green Tea - Ingredients: sweetener: xylite, gum base, flavour, humectant: glycerin, thickening agent: gum arabic, leaf extract (green tea), emulsifier: **soy lecithin**, colouring agent: titanium dioxide, coating agent: carnauba wax.

Chewing Gum with sweetener. Excessive consumption may produce laxative effects.

Xylitol Chewing Gum for Kids - Ingredients: sweetener: xylite, chewing base, aroma, acidity regulator: malic acid, thickening agent: gum arabic, humectant: glycerine, colourant: titanium dioxide, emulsifier: **soy lecithin**, coating: carnauba wax.

Chewing Gum with sweetener. Excessive consumption may produce laxative effects.

Tooth rinsing solution for plaque control

- Existing plaque is revealed in blue
- Pleasant "bubble gum" flavour
- Ready-to-use, motivating, child-friendly
- Colouring can be easily removed by brushing teeth
- Application: 1–2 x per day 10 ml, rinse for approx. 30 sec. prior to toothbrushing
- Erythrosine-free, alcohol-free
- Incl. dosing cap

Article description	Content	REF
Plaque Agent	500 ml	631 096
Plaque Agent Display	5 pcs.	635 176

Hygienic toothbrush holder

- Easy snapping in place and removing of toothbrush
- Patented snap lock
- Two suction cups for attaching to all even surfaces
- Ventilation slots ensure an ideal air exchange
- Fitting for any off-the-shelf toothbrush

Article description	REF
Funny cow	630 099
Funny elephant	630 100
Funny zebra	630 101
Funny lion	630 102
Funny pig	630 103
Funny dog	630 104

Children's Toothbrush

- Small head with oval bristle field
- Plane tuft field with soft rounded nylon bristles
- "Upper body" is hinged and protects the bristle field
- Air circulation by opening in the protective cap
- Brush handle simultaneously serves as practical stand
- For children from the age of four

Article description	REF
Duck	630 046
Parrot	630 047
Bear	630 048
Dog	630 049
Bull	630 051
5 pcs. assorted	605 820

Plaque Agent®



Funny Animals



Suction cups attachable to any smooth surfaces

Kid's Brush



LaserHF® „comfort“

Laser and HF technology combination device

- I-Cube design with touch screen control
- Preset programmes for all possible applications
- Individual control available additionally
- Highest possible functionality and hygiene
- Touch screen monitor for easy operation and selection of programmes

LASER:

- Disinfection and cleaning of gingival pockets in periodontitis
- Disinfection after root canal preparation in endodontics
- Removal of soft tissue, e.g. in implant surgery in periimplantitis
- Wound healing, pain relief and desensitisation by Low Level Laser Therapy (LLLT)
- PDT laser (photodynamic therapy)
- Optionally: accelerated bleaching by laser therapy

RADIO FREQUENCY:

- Two hand pieces working independently of each other for exchangeable electrodes (colour-coded): cutting- and cutting-/coagulation wave (yellow), coagulation wave (blue)
- All type of treatments are possible due to the three forms of frequency: Cutting, cutting with coagulation for haemostasis, coagulation, pulse-driven coagulation to gently weld small tissue pieces
- Automatic voltage control
- hf Bipolar forceps optionally available
- Handpiece and electrodes are autoclavable at 134 °C

Technical data:

HF power max. 50 W
 HF frequency 2.2 MHz
 Laser PDT: 660 nm/100 mW
 Laser 975 nm/8 W - cw/pulsed
 Measures (WxHxD) 30 x 13 x 25 cm
 Power supply 230V/50Hz
 HF 2.2 MHz/50 W – monopolar/bipolar
 Weight ca. 3.5 kg



User Report

Basic equipment

2 laser hand pieces (red for 8 W laser, orange for softlaser)
 1 x fibre tip 200 µm (set of 3) + 1 x fibre tip 320 µm (set of 3)
 Safety glasses Lambda One (800 – 975 nm)
 Over-spec Skyline (green, 800 – 975 nm)
 Over-spec Skyline (blue, 657 – 660 nm)
 Patient's safety glasses
 2 HF hand pieces (autoclavable)
 Set of electrodes (Nos. 40, 2, 13, 15, 31, 33)
 Neutral electrode, door contact/ interlock, foot pedal
 Instructions for use, medical product journal



Video

hf Bipolar Forceps to be ordered separately!

The standard LaserHF device is still available.

Article description	REF
LaserHF "comfort"	452 471
LaserHF Standard	452 462
hf Bipolar Forceps, 110 mm angulated	452 447
hf Bipolar Forceps, 160 mm angulated	452 455



LLLT



aPDT

Therapy laser

HF: Cutting

HF: Coagulation

Diode laser



	For all applications:		
	Laser	HF	LaserHF
Oral surgery	●	●	●
Periodontology	●	●	●
Implantology	●	●	●
Endodontics	●	●	●
Bleaching	●	●	●
aPDT	●	●	●
LLLT	●	●	●

Radio Frequency Surgery: Optimal Cutting and Coagulation

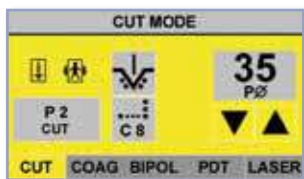

Cutting



Coagulation

Diode Laser 975 nm/8 W:
Periodontology, Endo-
dodontics and more

Therapeutic Laser:
LLLT, aPDT

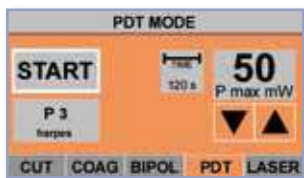
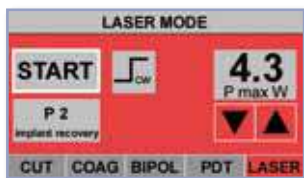

Exposure



Endodontics

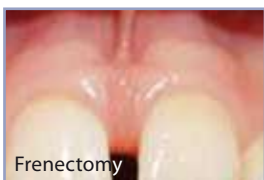

Frenectomy



Herpes

Universal HF surgery device

- I-Cube design with touch screen control
- Preset programmes for all possible applications
- Additionally offers individual programming
- Standard fitting: connection for bipolar forceps
- Highest possible functionality and hygiene
- Touch screen monitor for easy operation and programme selection
- Two individually working hand pieces for exchangeable electrodes (colour marked): cutting and cutting/coagulation wave (yellow), coagulation wave (blue)
- Due to three frequency forms, every application is possible: cutting, cutting with coagulation for haemostasis, coagulation, pulsed coagulation for gentle welding of smaller tissue particles
- Automatic voltage regulation
- Bipolar forceps optionally available
- Handpiece and electrodes are autoclavable at 134 °C

Scope of delivery:

Device with 2 autoclavable hand pieces, foot pedal, set of electrodes (6 pieces: Nos. 40, 2, 15, 13, 31, 33), neutral electrode

hf Bipolar Forceps to be ordered separately!

Frequency + power

2.2 MHz, max. 50 W
Voltage: 230 V/50 Hz
Unipolar and bipolar
Permanent/pulsed

Measures + weights

W 21.5 x H 11.7 x D 25 cm
Weight 2.65 kg

Article description	REF
hf1 Surg bipolar	452 459
hf Bipolar Forceps, 110 mm angulated	452 447
hf Bipolar Forceps, 160 mm angulated	452 455

For Laser protective glasses see page 92.

Low priced and sophisticated radio surgery unit

- For skalpellfine, pressureless incisions- frequency controll enables cut and cut/coagulation for hemostasis
- Fast and painless wound healing
- Easy handling of the analog intensity controll and frequency switch
- Automatic output management, fail safe mechanism when contact with metal
- Handpiece and electrodes are autoclavable at 134 °C

Scope of delivery:

Device with foot pedal, hand piece, 4 electrodes and neutral electrode

Frequency + power

2.2 MHz, max. 50 W
Voltage: 230 V/50 Hz

Measures + weights

W 19 x H 9 x D 18 cm
approx.. 3 kg

Article description	REF
hf Surg	452 400

hf1 Surg® bipolar

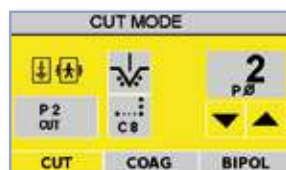

Source: Prof. Dr. med. Frank Liebaug

hf Surg®



hf Electrodes

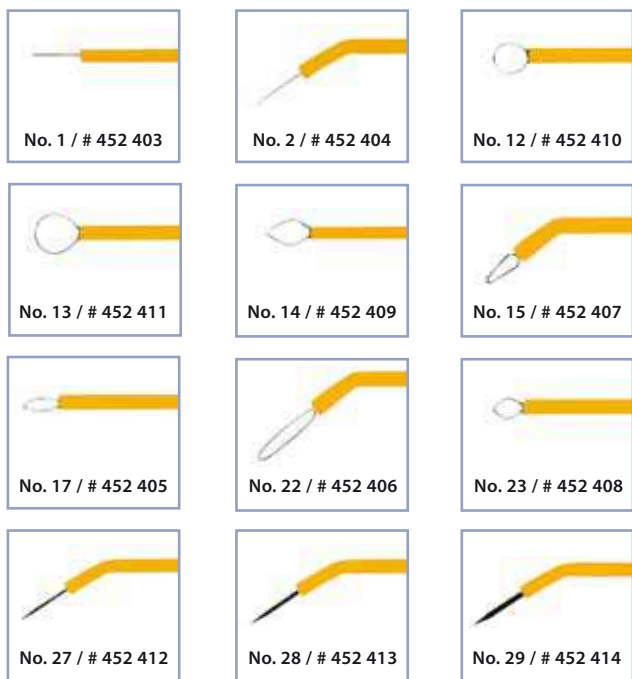

Article description	Content	REF
hf1, set of electrodes No. 40, 2, 13, 15	4 pcs.	452 441
hf1, set of electrodes No. 40, 2, 13, 15, 31, 33	6 pcs.	452 440

hf electrodes and hf Elepil set of electrodes on request



hf Neutral Electrode



Coated earth plate for optimal conduction of the hf waves

- Disinfectable

Please mention the serial number of your old appliance!

Further equipment available on request!

Article description	REF
Length 1.50 m	452 421
Length 2.0 m	452 422

LaserHF® PDT Solutions



PDT-solution for disinfection

- Specifically for the treatment with the LaserHF "comfort"
- Photo-activated disinfection of root canals, periodontal pockets and for treatment of peri-implantitis
- For Laser 660 nm, Fibre 320 µm

Article description	Content	REF
LaserHF Endo-PDT solution	set of 3 pcs., 0.8 ml each	155030
LaserHF Endo-PDT solution	set of 3 pcs., 1.2 ml each	155031

hf Bipolar-Forceps



Special forceps connection for the hf Surg devices

- Available in two lengths and shapes, without cable
- May be sterilised

Please note:

For first equipping, the hf Bipolar cable for the according hf Bipolar forceps needs to be ordered separately. Not included in the scope of delivery.

Article description	Form of Delivery	REF
hf Bipolar Forceps	110 mm straight	452 446
hf Bipolar Forceps	110 mm angulated	452 447
hf Bipolar Forceps	160 mm straight	452 448
hf Bipolar Forceps	160 mm angulated	452 455
Cable for Bipolar-forceps	1.50 m	452 456

Sterilisable fibre tips for the LaserHF device

- Available in 2 fibre strengths:
 ORANGE tip = 200 µm fibre, set with 3 pieces (sterile and individually packed)
 RED tip = 320 µm fibre, set with 3 pieces (sterile and individually packed)

Article description	Content	REF
LaserHF Fibre-Tip, red – 320 µm	3 pcs.	452 469
LaserHF Fibre-Tip, orange – 200 µm	3 pcs.	452 470

Bending tool for glass fibre tips

- For 200 and 320 µm glass fibre tips
- Safe handling to enable the appropriate degree of bending without damaging the fibre

Article description	REF
LaserHF Curver	452 480

Ceramic knife for scoring glass fibre tips

- Particularly suitable for scoring glass fibres
- Length of the ceramic blade 5–6 cm
- Please note: Ceramic blade is extremely sharp



Article description	REF
LaserHF Fibre Cutter	452 481

Laser hand piece particularly for bleaching

- With integrated optic and 2.50 m long conducting fibre for activating bleaching material (in-office), e.g. for the Mirawhite Laser Bleaching Gel (REF 607 086)
- Special optic inside hand piece ensures easy use and homogenous activation of the bleaching material on the tooth surface

Article description	REF
LaserHF Bleaching Hand Piece	452 472

Dental bleaching gel for use with diode laser

- Bleaching gel adapted for wave lengths
- For diode lasers 810 – 980 nm
- Two component bleaching gel in a 5g mixing cartridge
- With 35% hydrogen peroxide concentration for highly bleaching and brightening of vital and devital teeth

(When using in combination with the LaserHF device, the bleaching gel gets activated with the special LaserHF bleaching hand piece (REF 452 472).

Set consists of: 1 bleaching-gel cartridge with 35 % hydrogen peroxide 5 g, 3 mixing tips, 1 syringe with ginigiva protector 1 ml, 1 syringe with afterbleach care 2 ml, 2 applicators

Article description	REF
Mirawhite Laser Bleaching	607 086

LaserHF® Fibre-Tips

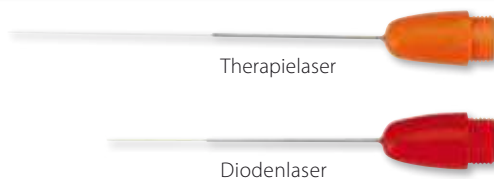

LaserHF® Curver



LaserHF® Faser Cutter



LaserHF® Bleaching Hand Piece



Mirawhite® Laser Bleaching



Integra® Cart De Luxe



Multifunction cart in two models

- Compressed air connection below the first tray (self locking compressed-air coupling)
- The middle tray is height-adjustable
- Easy-running and antistatic castors
- Castors can be locked

Integra Cart De Luxe

Upper tray:	outside (B x T)	36 x 41.8 cm
	inside (B x T)	35.6 x 41.5 cm
Centre tray:	outside (B x T)	38 x 40.3 cm
	inside (B x T)	37.6 x 40 cm
Lower tray:	surface (B x T)	40 x 45 cm

Overall dimensions: (H x W x D): 75.5 x 40 x 49.5 cm, weight: 18.8 kg

Article description	REF
Integra Cart De Luxe	460 115

Integra Cart De Luxe II

- Same as model De Luxe, but centre tray is equipped with a material drawer
- Drawer top is designed as a tray and can be used as deposit surface for small equipment

Drawer tray:	outside (B x T)	38.5 x 43 cm
	inside (B x T)	38.2 x 42.9 cm
Drawer:	height	9.5 cm
	inside (H x B x T)	8.2 x 31.2 x 26.4 cm

Overall dimensions: (H x W x D): 75.5 x 40 x 50 cm, weight: 22.8 kg

Article description	REF
Integra Cart De Luxe II	460 116

Integra® Fit-On Tray



Tray for the column of surgery lamp

- Suitable for all accessory devices (e. g. hf1 Surg bipolar), which are needed chairside
- Rotatable by two swivel-joints
- Handle mountable on long or short side
- Elegant and easy to mount to all columns
- Solid metal tray, max. load 3 kg
- Colour RAL 9002

Measures

Outside (W x D):	35 x 26 cm
Inside (W x D):	33.5 x 24.5 cm
Swivel arm:	23 cm long

Article description	REF
Integra Fit-On Tray with standard arm	460 103

The Fit-On Tray has to be ordered together with the fitting pipe flange to allow mounting.

Pipe flange incl. internal ring	ø mm	REF
For Planmeca	42	460 104
For other units	45	460 105
For Ritter	48	460 106
For Eurodent	50	460 107
For Sirona/Siemens	52	460 108
For Kavo/Flex Integral	55	460 109
For Ultradent/Faro	60	460 110

Proven wetting agent for all phosphate and plaster investment materials

- For exact and clean surface
- Wax-degreasing, reduces the surface tension of wax
- Dipol builds a molecular bridge between water-repellent wax and investment compounds which can flow bubble-free and accurately adapting to the wax. Clean, smooth surfaces
- It contains no delaying chemicals which can lead to rough surfaces
- Dipol is also suited excellently as wetting agent on impressions of silicone, polyether etc. for a trouble-free outpouring with plaster
- Free of formaldehyde and alcohol
- Without fuel gas, pumping atomizer with micro fine spray fog

Article description	REF
Set with 1 l bottle + 1 pump bottle (empty)	605 044
Pump bottle (filled), 100 ml	605 043

Isolates plaster from plaster

- Without any film build-up, not silicon binding
- Exact, very simple separation
- Plaster parts release without aid
- No discoloration of the models
- Surfaces are sealed against dirt and water
- Plaster surfaces can be polished brilliant with a brush or a cloth
- Without fuel gas, formaldehyde-free

Article description	REF
Set with 1 l bottle + 1 pump bottle (empty)	605 113
Pump bottle (filled), 100 ml	605 119

Disinfecting mixing liquid for all kinds of pumice powder

- Keeps the polishing compound creamy all day long
- Excellent bactericidal, fungicidal and tuberculocidal effect
- Virus-deactivating, effective against HBV and HIV viruses
- Skin-protecting, pH-neutral
- Biologically degradable and free from formaldehyde

Article description	REF
Mirawet, 5 l	554 105

Dipol®



Mirapor®



Mirawet®



Alminax



Aluminium wax

- For absolutely precise bite registration
- Stable wax sheets (3 mm thick)
- High percentage of aluminium keeps the sheets warm very well
- Extremely hard after cooling off
- Just heat up with warm water

Article description	REF
Alminax, 250 g	101 301

Alminax Rite-Bite



Preformed bite indexes from special aluminium wax

- Very stable due to a reinforcing aluminium section
- Precise bite registration without interfering with the tongue
- Warmed up quickly in 50 °C hot water, Rite-Bite is individually mouldable, cooled off extremely hard and shape-retaining
- 2.5 mm thick bite index for optimal bite registration and precise working
- Also ideal for face bow registration

Article description	REF
Alminax Rite-Bite, box of 24 reinforced and 6 plain indexes	101 302

Corund SC



Long-lasting finishing and grinding paper

- In the grain size 80 (coarse) - 220 (fine)
- For all materials - including porcelain
- 15 mm wide

Article description	Length	Grain	REF
Corund SC No. 80	25 m	80	605 016
Corund SC No. 100	30 m	100	605 017
Corund SC No. 120	30 m	120	605 018
Corund SC No. 150	30 m	150	605 019
Corund SC No. 180	50 m	180	605 020
Corund SC No. 220	50 m	220	605 021

Non-Stick®



Special silicone spray

- Isolation, protection and care spray
- Essential to ensure long service life of articulators
- Condyles, balls and all movable parts are gliding very easily
- For the surface isolation against plaster of model holders (norm)
- Prevents sticking of plaster on trimmers, flasks and elastic layers etc.
- Makes devices hinges smooth running

Article description	REF
Non-Stick, 400 ml	554 206

Occlu® Spray Plus



High-quality green occlusion spray

- For marking of contact points by direct spraying onto the occlusion surface
- Micro powder coating for highest accuracy
- Metal nozzle for extra fine spray mist
- Powder layer can be easily removed with water
- Economic in consumption

Article description	REF
Spray can, green, 75 ml	554 205
Spray can, green, 50 ml	554 211

Insulating varnishes for stumps etc.

- Silver- and golden-colored
- Even film of approx. 10 µm
- Indissoluble against isolating means and evaporation
- Heat-proof during the deep drawing and by the use of diving wax
- Quick-drying

Article description	Content	REF
Vernax S (silver), bottle with brush	20 ml	605 065
Vernax G (gold), bottle with brush	20 ml	605 066

- Clear liquid to thin Vernax 100, Vernax S., Vernax G as well as Vernax Antagon

Article description	Content	REF
Vernax thinner, bottle with brush	20 ml	605 068

Insulating varnish, 100 % of fine silver for stumps etc.

- Absolutely steady film of 8 – 10 µm (1 layer)
- Can also be applied in several layers
- Indissoluble against all isolating agents and evaporation
- Heat-proof during the deep drawing and by the use of diving wax
- Quick-drying
- Can be cleanly removed with acetone
- Recommended for full ceramic inlays and crowns, etc. (e.g., Empress, Ivoclar)

Article description	Content	REF
Vernax 100, bottle with brush	20 ml	605 063

Dust free protection varnish

- For hardening of plaster surfaces (e.g. antagonists)
- Coat thickness approx. 3 – 4 µm
- Scratch- and wear-resistant
- Transparent and very quick-drying
- Also as the first layer under Vernax 100, Vernax S and Vernax G

Article description	Content	REF
Vernax Antagon, bottle with brush	20 ml	605 067

Dark graphite in liquid form

- With integrated brush easy to apply
- Solder does not flow about the graphite limitation
- No lunker building within the joint
- Makes telescope and conical crowns move smoothly
- Diluteable with water

Article description	Content	REF
Vernax Colloidal Graphite, bottle with brush	20 ml	605 069

All Vernax products come with an integrated brush at the inside of the sealing cap.

Vernax® S / Vernax® G



Vernax® Thinner

Vernax® 100



Vernax® Antagon



Vernax® Colloidal Graphite



Mirapont®



A pale, highly exact special acrylat for stumps, hard plastic models and single teeth

- Very thin and slightly fluent material
- Both liquids (components A and B, relation 1:1) are mixed within 30 sec
- Can be poured into silicone, alginate, reversible hydrocolloids and thermoplastic
- After 90 min. it can be sawed, milled and polished

Article description	REF
Mirapont 500 g Contents: 250 g liquid A, 250 g liquid B, 2 dosage bottles A and B, 200 ml Agent Plus, 50 g Silifit, 5 measuring mugs, 1 mixing mug with pouring spout, 2 big mixing spatulas, 5 small mixing spatulas, one-way gloves	203 010
Mirapont 1.000 g Contents: 2 x 250 g liquid A, 2 x 250 g of liquid B, 2 dosage bottles A and B, 200 ml agent plus, 50 g silifit, 5 measuring mugs, 1 mixing mug with pouring spout, 2 big mixing spatulas, 5 small mixing spatulas, one-way gloves	203 011

Mirapont® Agent Plus



Mirapont Agent Plus

- Isolates Mirapont against waxes
- Isolates polyether and polysulfide materials against Mirapont

Article description	Content	REF
Mirapont Agent Plus	200 ml	203 016

Mirapont Silifit

- Special block-out material, kneadabler

Article description	Content	REF
Mirapont Silifit	250 g	203 015

Praxipol PS



Pressure polymerization vessel

- Approx. 4 l content
- For hot and cold polymerization
- Incl. inlet valve, pressure gauge and safety valve (GS/TÜV approved)
- Nonstick layer inside to avoid corrosion
- Weight approx. 2.5 kg only

Article description	REF
Praxipol PS	401 400
Additional hose with coupling, length: 2 m	401 401
Additional hose SP with ball valve, length: 2 m	401 402

Patented transport and storage box

- With two elastic, transparent membranes
- Ideal storage to safely send pieces of high-quality work
- Long durability due to high-quality material
- Stackable



Article description	REF
Medium: for bridges, partial dentures, attachments, etc	304 602

Transport and storage box with inside membranes

- Two membrane foils hold the contents gently and well visible
- Safety lock
- No rattling due to two membrane foils gently holding even smallest pieces
- Stackable

Article description	REF
Small: set with 12 pcs. for crowns, inlays, etc.	304 603
XXL: for 2 models	304 605

Ceramic compound with powdering crystals

- Base and colour pastes in a consistent spread, economical in use
- No mixing, condensing and blotting necessary
- Powdering crystals result in a thin, even layer
- Excellent colour brilliancy of the basic compounds and natural light reflection are achieved by using the powdering crystals
- Available in Biodent and V colors
- Suitable for all common, high fusion ceramic material
- High yielding and useful

Article description	REF
Carat Biopaque Basic Assortment V-Colours	604 204
Base paste separately	604 407
Powdering crystals separately	604 207

Isolating plaster fluid for ceramics

- Ideal to isolate plaster surfaces that get into contact with ceramics
- Thin isolation layer prevent sticking of ceramic material
- Suitable for all common ceramic materials

Article description	REF
Carat Isolation Fluid, 10 ml	604 222
Carat Isolation Fluid, 50 ml	604 223

A complete Carat catalog can be ordered free of charge, downloaded on our website or via enclosed QR code using your cell phone.

Membranbox

Medium



Medium (W x H x D)
8.5 x 2.2 x 9 cm

Small and XXL



Small (W x H x D)
4 x 1.9 x 4 cm



XXL (W x H x D)
19.2 x 4.8 x 9.2 cm

Carat® Biopaque®



Carat® Isolating Fluid



Carat Catalog

Speed Labolight®

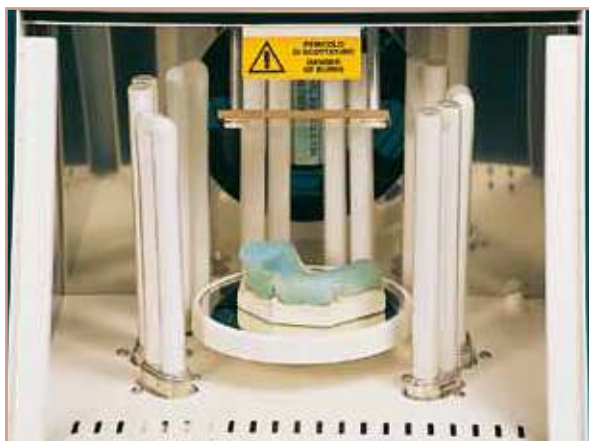

Universal light polymerization device

- For all light-curing dental materials
- Nanometer spectrum 320–550 nm
- Optimized light mixture for a homogenous and safe curing
- Circular arrangement of eight rod lamps around a turntable (dia. 14 cm) and one halogen lamp
- Interval turntable for an evenly light impact and curing
- Adjustable from one second to 99 minutes, protection against overheating, polymerization temperature in the chamber does not exceed 40 °C
- Durable (approx. 1,000 hours), easy-to-exchange lamps
- Acoustic signal indicates end of polymerization
- Operating hours counter

Technical data

Supply voltage:	230 V, 50 Hz
Power consumption:	225 W
Fuse:	1 x 2.5 A
Lamps:	8 x 9 W T1 (white light) 4 x 9 W T8 (UV-A) 1 x 150 W (halogen)
Size (W x H x D):	250 x 290 x 240 mm
Weight:	7 kg
Turntable:	Ø 14 cm

Article description	REF
Unit incl. 13 lamps	401 125

Separate single lamp

Article description	REF
T1 (white light) 9W / 71	901 002
T8 (UV-A) 9W / PLS-10	901 003
Halogen	901 004
Set (4 x T1 and T8, 1 x halogen each)	901 001

Balance® Articulator



The classical Non-Arcon articulator

- Precise, functional working device for complete and partial dentures as well as for crown and bridge works
- Worldwide the standard-Non-Arcon articulator
- Available in 2 construction heights: 95 mm, 105 mm (measurements without base plate)
- Joints and parts from stainless steel
- Torsion-resistant and free access to the model
- Extendable by numerous accessories as for example facial curve, foundation scales, calotte
- Mounting plates optionally available
- The balance with 20°, 30° or 40° condyles is available with 0°, 10° or 15° incisal plate

Technical data:

Condylar inclination	25°
Incisal table	5°
Bennett angle	0° bis 25°
Intercondyle distance	100 mm

Scope of supply:

Articulator, incisal table, incisal pin, 2 mounting plates, rubber bands
allen key

Article description	REF
Balance 95	203 201
Balance 105	203 295

Powerful, portable micromotor

- Allows working everywhere, ideal for home visits
- Infinitely variable motor with backward- and forward running (4,000 – 35,000 r/min)
- Lithium-ion accumulator for longer working times of up to 12 hours
- Recharging time approximately 5 hours
- Only for extraoral works
- Suitable for every standard hand and contra-angle piece with plane shaft without intra-spray and without light conductor
- May be attached to the belt, space-saving



Article description	REF
Bravo Portable III with belt bag and recharger	452 130

Article description	REF
Bravo Portable II with belt bag and recharger	452 102

**Unit comes without HP or CA.
For standard hand pieces and contra-angles see page 87.**

Collector-free AC motor (3-phase-motor)

- Small device for drilling, polishing, etc.
- Fits all conventional handpieces and contra-angles
- Speed infinitely and precisely variable from 1.000–30.000 rpm
- Forward and reverse rotation, with optic indication
- Solid, low-maintenance plastic body
- For extraoral use only

Technical data

Supply voltage:	230 V
Motor capacity:	max. 40 W
Size (H x W x D):	80 x 205 x 153 mm
Weight: approx.:	2.5 kg

Article description	REF
Bravo TD III	452 106

Bravo Marathon Portable III



Weight 300 g

Also available:
Bravo Portable II



Bravo TD III



Collector-free AC motor



Foot switch



Handpiece

Mirabol®



Green flexible mixing bowls

- Easy to clean
- For alginate, plaster, etc.
- Flexible material of first-class quality
- Available in three sizes/heights

Article description	ø	Height	REF
No. 1 (large)	12 cm	9 cm	304 331
No. 2 (x-large)	13 cm	11 cm	304 332
No. 3 (jumbo)	17 cm	13 cm	304 333
Plaster Spatula RS			304 314

Flex-O-Bol



Classic, dark green alginate mixing bowl

- Easy to clean, flexible
- For alginate, plaster etc.
- Available in 4 sizes

Article description	ø	Height	REF
No. 1/4 (small)	8 cm	5.5 cm	304 320
No. 1/2 (medium)	10.5 cm	7.5 cm	304 321
No. 1 (large)	12 cm	9 cm	304 322
No. 2 (x-large)	14 cm	11 cm	304 323

Algimix



Alginat mixing device

- Reliable, solid stainless steel body, maintenance-free
- Minimal time exposure
- Electronically controlled, even stirring movement mixes powder and liquid to an absolutely homogeneous bubble-free alginate mass
- High-quality, durable mixing bowl made of flexible silicone
- Stirring speed adjustable in two steps

Technical data

Voltage:	230 V
Power consumption:	100 W
Fuse:	1.25 A
Size incl. bowl (W x H x D):	13.5 x 23 x 20 cm
Weight with (without) bowl:	3.7 kg (3.5 kg)

Article description	REF
Device with bowl and spatula	452 045
Bowl only	452 046
Spatula only	304 317

Mirator® 2000



Electronically adjustable vibrator

- Continuously variable to up to 6,000 vibrations/min.
- Sturdy and powerful
- Worktop available separately upon request

Technical data

Worktop:	approx. 160 x 155 mm
Voltage:	220/240 V, 50/60 Hz
Power consumption:	max. 100 W
Safety fuse:	2.0 A
Weight:	3.0 kg

Article description	REF
Mirator 2000	401 344

Highly precise hydro impression material

- Favourable alternative
- The tray remains in the mouth for approx. 3 min. only
- Easy and quick handling
- Environmental-friendly disposal with household waste
- Combines the advantages of agar hydrocolloid with those of alginate
- Canula tips (package of 2) available separately upon request

Highly precise, inexpensive and time-saving impressions with the Algiloid System

The Algiloid system consists of algiloid hydro material as "light body" and customary alginate as "heavy body". Material must be used pre-warmed.

Article description	REF
Box of 48 cylinder ampoules	101 401
Algiloid cyringe III, incl. 2 attachments	101 405

Algiloid®



Device for heating up instruments

- Ideal to obtain anti-fog effect with mouth mirrors or instrument prior to treatment
- Not suitable for sterilisation
- Special heating element warms glass beads up to 230 °C and keeps the temperature constant without heating the outer body of the device
- Removable chamber, easy cleaning
- Size (W x H x D): Maxi 190 x 130 x 140 mm, chamber Ø 50 mm
Mini 165 x 115 x 115 mm, chamber Ø 35 mm

Device complete with glass beads:

Article description	REF
Mini, incl. 100 g glass beads	452 300
Maxi, incl. 200 g glass beads	452 303

Glass bead refill pack

Article description	Content	REF
Mini	100 g	452 301
Maxi	200 g	452 304

Glas Bead Heater



Mini

Maxi

Blue-Flame 1500



Handy burner for dental practice and laboratory

- Easy, practical one-hand operation
- Reliable ignition
- Solid freestanding burner, 15 cm only
- Flame temperature infinitely variable from approx. 800 – 1,300 °C, max. burning time approx. 35 minutes
- Refillable with APT gas (not included in scope of delivery)
- Diverse fields of application in household use

Article description	REF
Blue-Flame 1500	401 006

Please transport all burners only "empty".

APT III Burner



Convenient burner with one-hand operation

- Activation of ignition without having to put the instrument down
- Extra reliable ignition system
- Infinitely variable flame
- Transport securing
- Refillable with APT gas (not included in scope of delivery)



Article description	REF
APT III Burner	401 001

Kisag Burner



APT Gas

Gas burner for dental practice and laboratory

- Flame temperature infinitely variable from approx. 750 – 1,150 °C
- One filling for a burning time of 5–6 hours
- With the Swiss SVGW sign (equivalent to the German GS sign)
- Refill with Kisag gas only

Article description	REF
Kisag Burner incl. 400 ml Kisag gas	401 005
Kisag gas, 400 ml	605 140

Refill gas

- With various adapter tips to refill APT, Miratorch and Blue Flame burners, etc.
- Not suitable for Kisag Burner

Article description	Content	REF
APT Gas	200 ml	605 143

Handy burner for the practice and laboratory

- Can also be used as table device
- Ergonomic shape ensures save grip
- Blaze drain protection
- Burning temperature 1,300 °C
- Burning time approx. 60 – 70 minutes
- Very light: 220 g
- Diverse fields of application in household use
- Refillable with APT gas (not included in scope of delivery)

Article description	REF
Miratorch II	401 004

Still available: Miratorch

Article description	REF
Miratorch	401 010

Quiet denture cleaning device

- Aesthetic surface cleaning using rotating polishing needles in combination with a cleansing liquid – no material abrasion
- Integrated timer allows individual cleaning times
- Additional magnet keeps the needles in the container when replacing the liquid
- Autoclavable container

Technical data

Weight:	2 kg	Frequency:	50/60 Hz
Output:	35 W	Rotation:	1,700 rpm
Voltage:	230 V		

Article description	REF
Device with container, 50 g polishing needles (ø 0.6 mm) 1 litre of liquid and 1 magnet	401 136
50 g polishing needles, nickel-free stainless steel ø 0.6 mm for dentures	304 014
Speedo-Clean Liquid, 1 litre	554 106
Container separately	355 419
Magnet separately	304 012

Fully synthetic cleaning product for cleaning and high-gloss polish of acrylic artificial dentition

- Aesthetically upgrades the presentation of your prosthetic works
- For the removal of polishing agent and monomer residues from prosthetic work
- Spray on and leave for a short while before wiping off with a soft cloth
- Pleasant flavour: mint

Article description	Content	REF
Protho Clean	75 ml	554 220

Miratorch® II



Speedo-Clean®



Protho Clean®



Airsonic® Mini Sandblaster



Handy sandblaster

- For roughening of bonding surfaces of crowns, bridges, brackets, posts, etc.
- Thoroughly roughened bonding surfaces for optimal bonding of various materials
- Ideal for all metals and ceramics
- Also suitable for the removal of cement residues from crowns and bridges

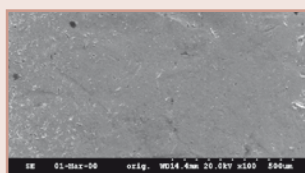

Before sandblasting

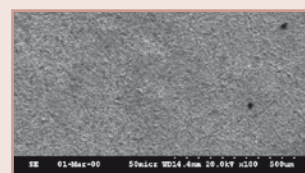

After sandblasting

Article description	REF
Sandblaster, standard nozzle 60° and 20 g powder (50 µm)	401 080
Nozzle 60° separately	401 086

Airsonic® Adapters

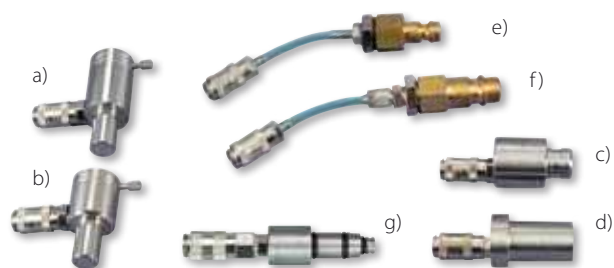

Article description	REF
a) Adapter K for direct connecting to Kavo turbine	401 084
b) Adapter S for direct connecting to Sirona titan turbine	401 089
c) Connection to W+H Rotoquick	401 077
d) Bien Air Unifix	401 076
e) Connection to EMS box	401 090
f) Connection to lab coupling	401 091
g) Adapter for direct connecting to NSK	401 075

Airsonic® Absorbo Box



Airsonic® Alu-Oxide

Handy absorber box

- Portable absorber box – the abraded material remains in the box and is completely collected in the filter
- Very low-noise and high-performance device
- Solid and durable design
- Problem-free cleaning by removable filter
- No separate aspiration system required
- Ideal for practice and practice laboratory in combination with the Airsonic mini sandblaster (REF 401 080)

Technical Data:

Size (W x H x D): 35.6 cm x 22 cm x 37 cm

Weight: only 2.8 kg

Equipment available on request

Article description	REF
Airsonic Absorbo Box	401 082
Replacement filter separately	401 092
Replacement pane available on request	

AL₂O₃ powder for sandblasting

Article description	Content	REF
Airsonic Alu-Oxide, 50 µm	500 g	605 084
Airsonic Alu-Oxide, 90 µm	500 g	605 086

Prophylaxis straight hand pieces and contra-angles

- For prophy cups and brushes with screw and button fixation
- From 0 – 5,000 rpm
- Fit any standard micro motor with plane shaft (e. g. Bravo Portable II)
- Autoclavable



Article description	REF
WST (angle piece) button fixed	452 152
WST (angle piece) screw fixed	452 153
HST R 4:1	452 159

For Prophy-Angles see page 47.

Standard hand pieces and contra-angles

- Fit any standard micro motor with plane shaft
- Autoclavable

Article description	REF
WST (angle piece) 30,000 rpm	452 150
HST (hand piece) 40,000 rpm	452 158

Drip off holder for hand-pieces

- For surplus oil collection
- Holds 8 hand or contra angle pieces
- Size: Height approx. 12.3 cm, ø 12.1 cm
- Autoclavable



Article description	REF
Instrument holder with 5 drip pads	452 160
Refill pack with 20 drip pads	452 161

Orbatec® Prophy



Button fixation

Screw fixation

HST R

Orbatec®



WST

HST

Orbatec® Holder



Hager Outbacks



Hot Pink

Protection and elegance at work

- Modern polishing techniques reduce distortions
- Fog reduction is the effect of a special ventilation system
- Light weight frame prevents pressure on head and ears
- Silicone nose piece prevents sliding
- Silicone grips on temples
- Each pair includes a free neck strap (black)



Article description	Lenze	REF
Gold	Clear	304 700
Red	Clear	304 701
Black	Clear	304 702
Hot Pink	Clear	304 703
Pink	Clear	304 704
Purple	Clear	304 705
Blue	Clear	304 706
Green	Clear	304 707
Silver	Clear	304 710
Black Sunglass*	Tinted	304 709
Neck strap black, separately		304 711



Silver

25 g



Gold

25 g



Red



Green

25 g



Pink



Purple



Hot Pink



Blue



Black Sunglass with black tinted lenses

*no protective glasses



Black



uvex
PROTECTING PEOPLE

Trendy protective glasses with wide field of view and perfect all-around vision

- Dual spherical protective glass offers ideal coverage of the eyes even in the area of the eye brows.
- Temple with integrated „climate-zone technology“ ensures you can work longer without fatigue
- High wearing comfort due to non-slip components
- Especially for slender faces: uvex Pheos small
- Coating: Outside extremely scratch-resistant, inside anti-fog coating

Article description	Lens	REF
Frame light grey/grey	clear	355 607
Frame black/green	clear	355 608
Frame black/orange	grey	355 609
Small: Frame white/green	clear	355 610
Small: anthrazit/grey	clear	355 611

Stylish and slim protective glasses

- Protective glasses with unobstructed side view
- Especially suitable for slender head shapes
- Length and angle of sides individually adjustable
- Excellent chemical resistance

Article description	Lens	REF
Frame blue/black	clear	355 562
Frame red/black	clear	355 564
Replacement lens	clear	355 568

Original design and maximum safety

- All-around view
- Temple length and angle individually adjustable
- Pressure-free fit

Article description	Lens	REF
Frame white	clear	355 518
Frame yellow/black	clear	355 519
Replacement lens	clear	355 521

Extreme light and modern safety glasses

- Anatomically shaped wrap-around lens
- Extreme wide peripheral and highly protected field of vision
- 20 % larger coverage versus regular temple glasses
- Coating: outside extremely scratch-resistant, inside anti-fog coating

Article description	Lens	REF
Frame black	grey*	355 598
Frame black	clear	355 599

* no anti-fog coating

uvex Pheos

iSpec Pure Fit



uvex Astro Lite

iSpec Classic Fit



uvex Astrospec

iSpec Safety Fit



uvex X-Trend

iSpec X Fit



uvex Astrospec 2.0

iSpec Safety Fit II



43 g



Optimum eye coverage and large panorama lenses

- Variable side arm inclination (3 notches)
- Maximum wearer comfort for all face shapes due to flexible 2K side arms technology
- Optimal ventilation due to labyrinth seal
- Folds flat and fits into all pockets
- Coating: extremely scratch-resistant, inside anti-fog coating

Article description	Lens	REF
uvex Astrospec 2.0 blue	clear	355 624
uvex Astrospec 2.0 lime	clear	355 625

uvex super fit CR

iSpec Steril Fit



21 g

39 g

Autoclavable safety eyewear

- Unique autoclavable glasses with anti-fog performance
- High wearer comfort due to soft temples
- Coating: extremely scratch-resistant, inside anti-fog coating
- Ideal for laboratories and clinics
- OTG suitable for persons wearing glasses

Article description	Lens	REF
uvex super fit CR	clear	355 510
uvex super f OTG CR	clear	355 511

uvex I-VO

iSpec Comfort Fit



Fashionable multi-component protective eyewear

- High wearing comfort through hard/soft components
- Temple length individually adjustable
- Brown lens is chemical resistant
- Coating: outside extremely scratch-resistant, inside anti-fog coating

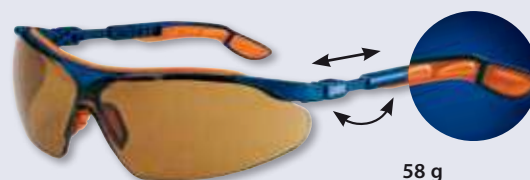

58 g

Article description	Lens	REF
uvex I-VO "S" blue/orange	brown*	355 590
uvex I-VO blue/grey	clear	355 589
Replacement lenses brown* and clear on request		

* no anti-fog coating

uvex Super-Fit UV

iSpec Slim Fit UV



UV protective eyewear

- Safe protection against UV radiation in extended wavelength range of 350 – 523 nm
- For all light polymerisation units
- Tested by NIOM (Nordic Institute of Dental Materials)
- Weight: 21 g
- Coating: outside extremely scratch-resistant, inside mist-free

Article description	Lens	REF
uvex Super-Fit UV	orange	304 427



Sporty, dynamic metall frame

- High flexibility and low weight due to thin metall frame cross section
- Innovative frame without spring hinge, screw-free lens mounting
- Flexible nose bridge, individually adjustable
- Perfect hold for almost all head shapes

Article description	Lens	REF
uvex Racer	clear	355 605

Very light Over-The-Glass (OTG)

- No contact of temples with the prescription glasses
- Good coverage of the eye area by flat basic curve
- Soft, extra flexible temple tips



37 g

Article description	Lens	REF
uvex Super OTG	clear UV 2C-1,2	355 539

Face shield

- Made of non-reflecting polycarbonate
- Lightweight frame for fixing to the head (25 g)
- Ideal for works with prophylaxis blasting units
- Avoids infection risk from patients

Article description	REF
White frame with 5 replacement shields	355 535
Transparent blue frame with 5 replacement shields	355 546
Pack with 5 replacement shields	355 536

Face Shield

- Highly impact-resistant and can be hinged upwards
- Fits any head size – adjustable Velcro fastening
- No light or colour reflex
- For working in the laboratory, etc.

Article description	REF
CC-Shield	355 508

uvex Racer

iSpec Dynamic Fit



62 g

uvex Super OTG

iSpec Fit OTG



Proto-Cam®



CC-Schild



H&W Classic



28 g

Stylish and comfortable protective eyewear

- Soft sides, adjustable with lock-in-place extension
- Provides full protection with 180° unobstructed view
- Anti-fog and anti-scratch clear lens with HC/AF coating
- 100 % impact resistant polycarbonate lens

Article description	REF
H&W Classic	355 622

H&W Panorama



24 g

Safety glass with panorama view and side protection

- Ergonomic temples
- Nose bridge of soft and anti-slip rubber
- Anti-fog and anti-scratch clear lens with HC/AF coating

Article description	REF
H&W Panorama	355 620

H&W Featherlight



22 g

Ultra-lightweight protective eyewear

- Soft temples with adjustable notches
- Adjustable soft nosepiece for a superior anti-slip fit
- Comfortable full wraparound protection
- Anti-fog and anti-scratch clear lens with HC/AF coating
- Polycarbonate lens

Article description	REF
H&W Featherlight	355 621

laservision



Laser protective glasses in modern design

- 1) Lambda One: certified safety grade LB4, for Laser 800 – 1064 nm*, 27 g
- 2) laservision green: over the glasses with the same properties, 51 g
- 3) laservision blue: over the glasses for dioden-Softlaser 657 – 660 nm*, 51 g
- 4) Glasses for patient: wideband protection* by special metal insert

Article description	REF
1 laservision Lambda One	355 630
2 laservision green	355 631
3 laservision blue	355 632
4 laservision laserglasses for patient	355 633

*All of our glasses are LaserHF compatible. Should you use another laser, please calculate the safety grades your laser requires and compare them with the information stated on the laser safety glasses, before using them.

Safety glasses with anti-slip nose bridge

- Temple length individually adjustable
- Adjustable soft nosepiece for a superior anti-slip fit
- Comfortable full wraparound protection

Article description	REF
H&W Sports Pro	355 619

Panorama overspecs

- No contact of temples with the prescription glasses
- Good coverage of the eye area

Article description	REF
H&W OTG II	355 618

Temple length individually adjustable

- All-around view

Article description	REF
H&W Logic	355 616

For slender faces

- Ergonomic temples

Article description	REF
H&W Panorama II	355 617

Spray disinfection

- Particularly for disinfection of protective (uvex) glasses
- No damage to the anti-fog coating
- Generally usable for all surfaces in the medical field
- Bactericidal, fungicidal and virus-inactivating (HBV and HIV)

Article description	Content	REF
Astro Clean	250 ml	554 301

H&W Sports Pro



30 g

H&W OTG II



38 g

H&W Logic



32 g

H&W Panorama II



25 g

Astro Clean®



Successful periimplantitis prophylaxis

Autor: Prof. Dr. Dr. C. U. Fritzscheier, Düsseldorf, Germany



Prof. Dr. Dr. Claus Udo Fritzscheier

- Born in Hamburg 1940
- Studies of medicine and dentistry in Berlin/Zürich/Hamburg
- Certificate for dentistry 1968
- Doctor's degree for dentistry and medicine 1972/74
- Certificate for medicine 1974
- Qualification as specialist for Oral- and Maxillofacial Surgery 1978
- Qualification as professor for Oral- and Maxillofacial Surgery at the University of Düsseldorf, Germany 1984
- Emeritus professor since 2006
- Speaker and consultant since 2010

Preface

During the last decades, implantology emerged as one of the most innovative enrichments in the field of dentistry. Considerable increase is expected in the future. Compared to earlier preprosthetic methods, endosseous implantology is a simple treatment that usually is not very stressful for the patients and offers many advantages, e.g. the physiological transfer of chewing forces into the bone,

which - under certain conditions - even generates renewed bone growth.

Against this background and since implantology with all its prosthetic treatments varieties is considered an established method.

One of the most common and most feared complications occurring in implantology is periimplantitis (Fig. 1), which usually leads to implant loss in case it remains untreated.

Introduction

Initially, the periimplant tissue disease manifests itself as mucositis with progressive bone loss at the implant area, as described by ALBREKTSSON et al. The reasons for this disease pattern are complex, and various hypotheses about the development of periimplantitis were proposed, amongst them insufficient oral hygiene, lack of fixed gingiva, and/or overstressed implants. These putative triggering factors contradict the statements of well-known implantologists. „An absence or insufficient width of keratinized gingiva is not aetiologically linked to the development of gingivitis and periimplantitis“ or „The functional strain placed on an implant cannot be solely held responsible for progressive bone loss“. That means that additional pathologic influences, which trigger and sustain the process of disease, must exist next to these ostensible causes.

Therapies reach from improved basic hygiene to antibiotics and disinfectant inserts into periimplantal pockets up to ultrasound treatments and laser curettage of inflamed tissues. The main attention, however, should not be placed on therapy, but rather onto an efficient prevention of periimplantitis.

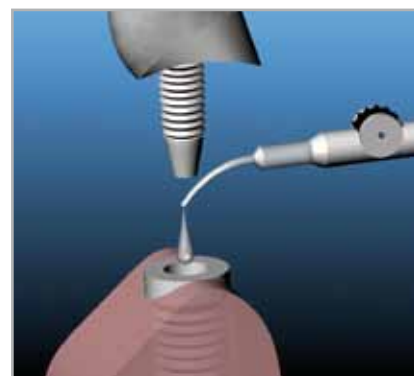

GapSeal®, Hager & Werken



Fig. 1: Periimplantitis clinical and X-ray

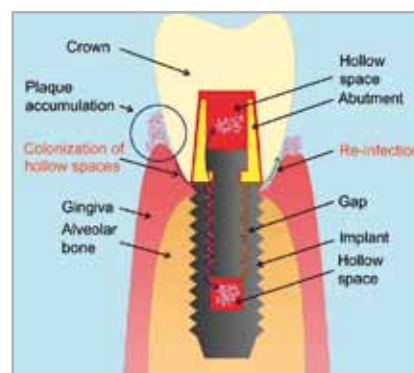

Fig. 2: Design drawing showing an assembled endosseous implant, hollow spaces inside implant and suprastructure are highlighted in red



For reading the complete report please scan the QR-Code.

User Report



Tel + 49 (203) 99 26 90

Fax + 49 (203) 29 92 83

Dental practice: _____

Contact person: _____

Phone: _____ **Fax:** _____

E-Mail: _____ **URL: www.** _____

Address: _____ **Country:** _____

Dental dealer: _____

in (important for delivery): _____

Quantity	REF	Article

Quantity	REF	Article

Please send me information regarding the following products: _____

Hager & Werken GmbH & Co. KG
 Ackerstraße 1 · 47269 Duisburg, Germany
 Telefon +49 (203) 99269-0
 Fax +49 (203) 299283
 E-Mail info@hagerwerken.de
 Internet www.hagerwerken.de





Your partner for dental specialities, ideas and service.



Häger & Werken GmbH & Co. KG
Ackerstraße 1, 47269 Duisburg, Germany
Tel. +49 (203) 99269-0
Fax +49 (203) 299283
E-Mail info@hagerwerken.de
Internet www.hagerwerken.de

Please see our general terms and conditions
at www.hagerwerken.de



Exhibition stand
360°



Follow us